

STORM | GROUP

**ACCESSORIES
& CAR CARE**



**20
24**

MÖLDER

- 5 Antifreeze/Winter glass washer
- 7 Gasket maker
- 8 Adhesives/Sealants
- 9 Grease

MÖLDER TOOLS III

- 10 Professional tool kit
- 15 Flexible gear wrench
- 16 Reversible ratchet wrench
- 17 Flat gear wrench
- 18 Combination spanner
- 19 Flare nut wrench/Combination spanner set

MÖLDER

- 20 Filters

BELAUTO

- 24 Car air compressor
- 32 Hand pumps
- 34 Food pumps
- 35 Jerry cans
- 36 Car vacuum cleaners
- 40 Hydraulic bottle jacks
- 43 Professional floor jacks
- 44 Scissor jacks
- 46 Booster cables
- 48 Ratchet tie down
- 50 Tow ropes
- 51 Car phone holders
- 56 PVA cloth/Cigarette socket
- 58 Battery terminals
- 59 Fuses
- 62 Cable ties
- 63 Insulation PVC tape

BELAUTO OFF ROAD

- 65 Professional electric winches
- 68 Bark protection cables
- 69 Tow ropes
- 70 LED lighting

BELAUTO

- 94 Antifreeze concentrate
- 96 Antifreeze

SONAR

- 98 Car horns

BI-PLAST

- 103 Winter snow brushes
- 107 Brushes/Water scrapers
- 109 Jerry cans
- 110 Brushes/Water scrapers
- 111 Windshield wipers/Hangers

JBL

- 113 Solar window film

Beltex

- 115 Car carpets
- 120 Car seat cushion
- 124 Car seat covers
- 129 Headrest covers
- 130 Trunk organizer
- 132 Organizer bags
- 133 Bags for hydraulic jack
- 134 Wheel cover/Reflective bracelets
- 135 Signal vests/Reflective armband

URAGAN

- 137 Car air compressors

STORM

- 142 Car air compressors

SOLAR electric

- 146 LED headlight lamps
- 151 Selection of led lamps 12V
- 152 LED signal lamps
- 156 LED signal lamps 12V
- 160 LED signal lamps 24V
- 163 Xenon lamps
- 167 Selection of halogen lamps 12V
- 168 Halogen lamps 12V
- 171 Signal lamps 12V
- 173 Signal lamps 24V
- 175 Insulation PVC tape
- 176 Double-sided foam tape
- 177 Double-sided adhesive tape
- 178 Automotive fuses

BREVIA

- 181 Xenon lamps
- 186 Halogen lamps 12V
- 190 Signal lamps 12V
- 194 Selection of lamps 12V
- 196 Lamps for trucks 24V
- 197 Selection of lamps 24V
- 198 Automotive lamps 24V
- 200 LED signal lamps
- 204 LED inspection lamps

ALLIGATOR

- 215 Battery charger & starter
- 216 Battery charger
- 220 Booster cables
- 221 Booster cables/Clamps

CarLife

- 223 Hydraulic bottle jack
- 226 Hydraulic floor jack
- 228 Scissor jack
- 229 Tow ropes
- 231 Ratchet tie down
- 232 Foot pumps
- 233 Hand pumps
- 234 Tire pressure gauge
- 235 Mud flaps/Tubeless tire repair kit
- 236 Automobile wrench
- 237 Automobile tools
- 238 Car cloth
- 240 Car cleaning sponges/Luggage nets
- 241 Elastic straps/Organizers
- 242 Battery terminals/Cigarette lighters
- 243 Cigarette lighter socket/Anti-slip mats
- 244 Car phone holders
- 246 Auxiliary mirrors/Hydrometers/Safety belt clips
- 247 Sun shades
- 248 Licence plate holders
- 249 Car funnels/Jerry cans
- 249 Steering wheel knobs/Gear shift covers
- 250 Wheel covers
- 251 Leather wheel covers
- 254 ECO leather wheel covers
- 257 Combination wrench
- 258 Tube wrench/Combination wrench set
- 259 Screwdrivers
- 260 Screwdriver set
- 261 L-Shaped wrenches
- 263 Pliers tools
- 266 Gas torch
- 268 Cable ties
- 269 Hose clamps Cobra

PROFI

- 270 Hose clamps

NOWAX

- 272 Gas torch
- 274 Professional tool
- 277 Adhesives
- 279 Gasket maker

Permatex

- 281 Sealants/Adhesives

VersaChem

- 288 Sealants/Adhesives

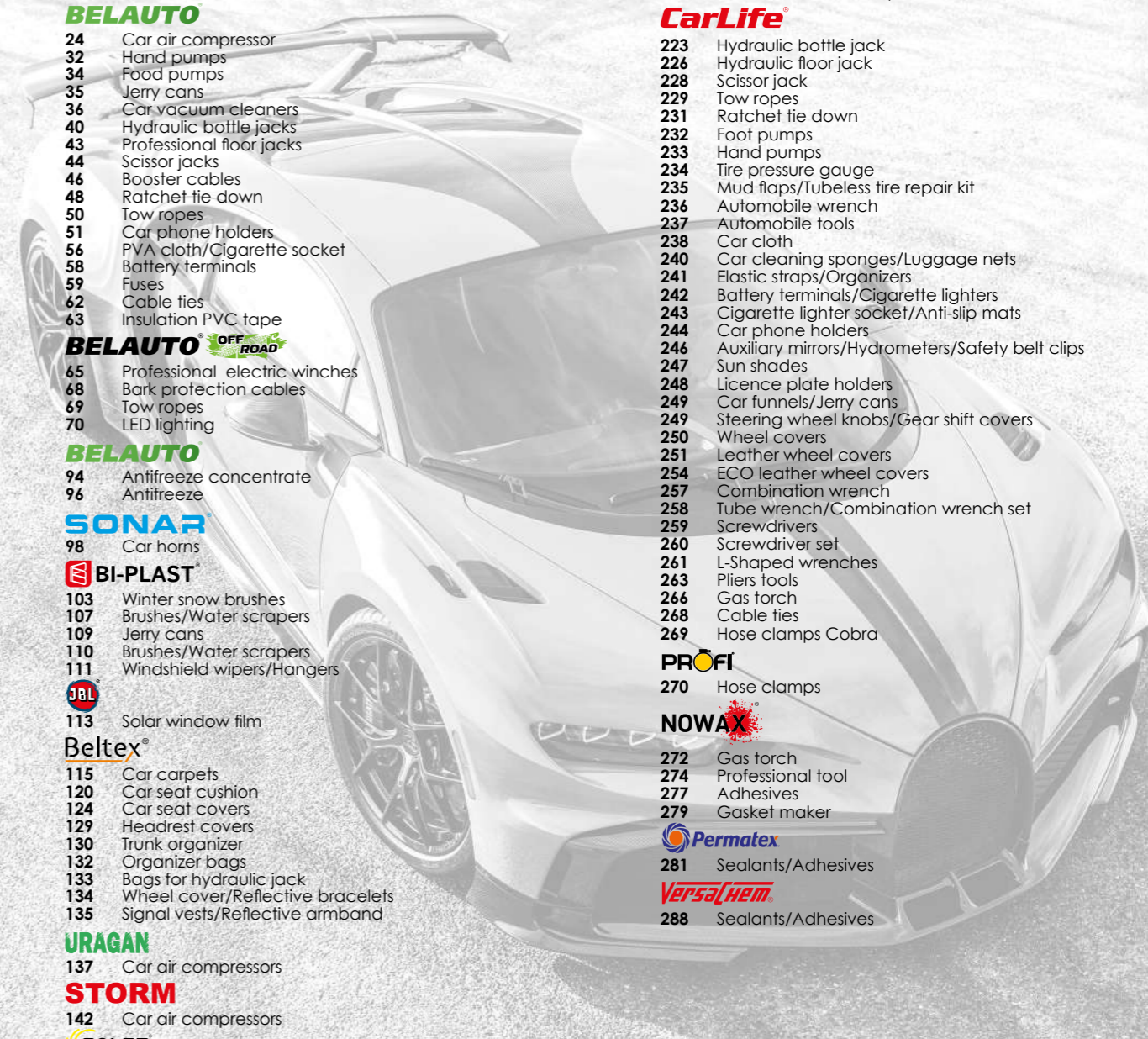

MÖLDER®

ANTIFREEZE CONCENTRATE

G12 G11 G11



-  **Schützt vor Korrosion und Gefrieren und erhöht den Siedepunkt**
Protects against corrosion and freezing and raises the boiling point
-  **Schützt das Kühlsystem vom Kalk**
Protects the cooling system from limescale
-  **Entspricht den Anforderungen Automobilindustrie**
meets the requirements of the automotive industry

PROFESSIONAL CAR CHEMICAL

MÖLDER®

ANTIFREEZE
WINTER GLASS WASHER

art. UKF-050-G11GRN ANTIFREEZE CONCENTRATE

Volume: 5 L
Barcode: 4820257880042
Packaging: 4 pcs.



art. UKF-015-G11GRN

Volume: 1,5 L
Barcode: 4820257880035
Packaging: 12 pcs.

G11 -40°C

Mölder Antifreeze Concentrate G11 Green coolant concentrate for cooling engines of domestic and imported cars. Premium additives prevent the formation of corrosion and freezing, increase the boiling point. Protects the cooling system from calcification. Strict observance of the specified proportions guarantees preservation of all knots of cooling system and increase in service life of engines from aluminum and gray cast iron. Resistant to freezing at temperatures down to -40°C (subject to a ratio of 1: 1). Antifreeze fully meets the requirements of the automotive industry and all modern requirements for technical fluids. Does not contain nitrates, amines, phosphates.

ANTIFREEZE CONCENTRATE

Mölder Antifreeze Concentrate G11 Blue coolant concentrate for cooling engines of domestic and imported cars. Premium additives prevent the formation of corrosion and freezing, increase the boiling point. Protects the cooling system from calcification. Strict observance of the specified proportions guarantees preservation of all knots of cooling system and increase in service life of engines from aluminum and gray cast iron. Resistant to freezing at temperatures down to -40 ° C (subject to a ratio of 1: 1). Antifreeze fully meets the requirements of the automotive industry and all modern requirements for technical fluids. Does not contain nitrates, amines, phosphates.

art. UKF-050-G11

Volume: 5 L
Barcode: 4820257880066
Packaging: 4 pcs.

art. UKF-015-G11

Volume: 1,5 L
Barcode: 4820257880059
Packaging: 12 pcs.

G11 -40°C



art. UKF-050-G12 ANTIFREEZE CONCENTRATE

Volume: 5 L
Barcode: 4820257880028
Packaging: 4 pcs.



art. UKF-015-G12

Volume: 1,5 L
Barcode: 4820257880011
Packaging: 12 pcs.

G12 -37°C

Mölder Antifreeze Concentrate G12 Red coolant concentrate for cooling engines of domestic and imported cars. Premium additives prevent the formation of corrosion and freezing, increase the boiling point. Protects the cooling system from calcification. Strict observance of the specified proportions guarantees preservation of all knots of cooling system and increase in service life of engines from aluminum and gray cast iron. Resistant to freezing at temperatures down to -37°C (subject to a ratio of 1: 1). Antifreeze fully meets the requirements of the automotive industry and all modern requirements for technical fluids. Does not contain amines, phosphates, silicates. Suitable for all-season use.

WINTER GLASS WASHER -20°C

Ready-to-use premium winter glass washer for protection against freezing and removal of road dirt from the glass and headlights of the car at temperatures down to -20°C. Effectively removes salt and oil contaminants from car glass. Prevents the formation of ice crust and other frosts. Prevents freezing of the tank, nozzles (including flat flares) and other elements of the windshield washer system. Does not contain acetone and methanol. Neutral to rubber and metal elements of wiper blades, rubber seals, car paint, polycarbonate glass. Does not leave stains. It has a pleasant aroma.



art. SCH-20C-51

with lime scent
Volume: 5 L
Barcode: 4820257880080
Packaging: 4 pcs.



art. SCH-20C-50

with sport scent
Volume: 5 L
Barcode: 4820257880073
Packaging: 4 pcs.

MÖLDER®

MÖLDER®

GASKET MAKER



GRAY



Barcode: 4036231703430
Packaging: 10/120 pcs.

art. **SIL343**
GRAY HIGH-TEMPERATURE 100% SILICONE SEALANT GASKET MAKER 85 g +343°C

Elastic, fast-hardening, solvent-free silicone sealant for sealing gaps in flat joints (without dismantling parts).

Properties:

Heat resistance from -50°C to +343°C (short-term maximum temperature). High resistance to such chemical environments as diesel fuel and fuel for internal combustion engines, oils, fats, greases, water, sea water, sunlight and ozone.

Areas of application:

For sealing all surfaces of seals in the engine, gearbox, axles, for sealing cylinder liners and crankcases. Good adhesion with rough surfaces. Approved for use in all European and Japanese cars.

Operating Instructions:

1. Remove the remains of sealants and other materials
2. Clean the surface, degrease it and let it dry.
3. Apply sealant on one side and immediately install the parts.
4. Effectively seal small gaps, in other cases observe the mass hardening time (0.1-0.2 mm/h).
5. After use, close with a protective cap.

art. **SIL370**
RED HIGH TEMPERATURE 100% SILICONE SEALANT GASKET MAKER 85 g +370°C

Elastic, fast-hardening, solvent-free silicone sealant for sealing gaps in flat joints (without dismantling parts).

Properties:

Heat resistance from -50°C to +343°C (short-term maximum temperature). High resistance to such chemical environments as diesel fuel and fuel for internal combustion engines, oils, fats, greases, water, sea water, sunlight and ozone.

Areas of application:

For sealing all surfaces of seals in the engine, gearbox, axles, for sealing cylinder liners and crankcases. Good adhesion with rough surfaces. Approved for use in all European and Japanese cars.

Operating Instructions:

1. Remove the remains of sealants and other materials
2. Clean the surface, degrease it and let it dry.
3. Apply sealant on one side and immediately install the parts.
4. Effectively seal small gaps, in other cases observe the mass hardening time (0.1-0.2 mm/h).
5. After use, close with a protective cap.

RED



Barcode: 4036231703706
Packaging: 10/120 pcs.

PROFESSIONAL GREASE AND SEALANTS



art. P 9090
POLYURETHAN ADHESIVE FOR AUTOMOTIVE GLASS

Volume: 310 ml
Barcode: 4002873190907
Packaging: 12 pcs.

art. P 9091
POLYURETHAN ADHESIVE FOR AUTOMOTIVE GLASS

Volume: 600 ml
Barcode: 4002873190914
Packaging: 20 pcs.



art. P 930
U-Primer 130
ADHESIVE PRIMER FOR BONDING GLASS

Volume: 30 ml
Packaging: 25 pcs.

Ready-to-use one-component polyurethane glue-sealant Mölder is designed for fastening the front, side and rear glass in the car. It is easily applied manually by spraying with a specialized gun, as well as with the help of industrial equipment. Adhesive sealant hardens as a result of a chemical reaction with air, has excellent adhesion to glass, metal and other materials. Resistant to the effects of ultraviolet radiation and thermal loads. It has good strength characteristics and deformation qualities after hardening.

Properties:

The formation time of the surface film is about 15 minutes. (Tack-Free Time 23°C, 50% relative humidity). High strength and good elasticity even after a long period of operation. Very good resistance to sagging. High resistance to ultraviolet radiation.

Field of application:

It is used for fixing the front, rear and side glass to the body of the vehicle (cars and trucks, buses). Recommended for warranty repair of European and American cars. The product is intended for professional use.

AUTOMOTIVE POLYURETHANE SEALANT



art. PU 9080
Volume: 310 ml
Barcode: 4002873190808
Packaging: 12 pcs.



art. PU 9081
Volume: 310 ml
Barcode: 4002873190815
Packaging: 12 pcs.



art. PU 9082
Volume: 310 ml
Barcode: 4002873190822
Packaging: 12 pcs.

Polyurethane quick-drying one-component sealing seam sealant with high strength and elasticity. It has vibration- and noise-absorbing properties.

Properties:

The formation time of the surface film is about 25 minutes. (Tack-Free Time 23°C, 50% relative humidity). High strength and good elasticity even after a long period of operation. Very good resistance to sagging. High resistance to ultraviolet radiation.

Field of application:

It is used to restore almost any seams and joints in accordance with the requirements of the automotive industry. Recommended for warranty repair of European and American cars. The product is intended for professional use.



MOLYBDENUM GREASE EP2

art. MR 130300

Volume: 300 g
Barcode: 4036231303005
Packaging: 36 pcs.

art. MR 130100

Volume: 100 g
Barcode: 4036231301001
Packaging: 80 pcs.

BLACK

Universal multi-purpose grease, developed using an optimized combination of high-quality mineral oil and the addition of heat-stable lithium complex soap. A specially selected package of additives allows to achieve reliable operation in a wide range of temperatures.

Properties:

Operating temperature range: from -35°C to +120°C. Has excellent sealing properties, waterproof. Provides reliable protection against wear, resistance to oxidation and corrosion. It is used as a standard grease for cars.



UNIVERSAL GREASE MP2

art. MR 120300

Volume: 300 g
Barcode: 4036231203008
Packaging: 36 pcs.

art. MR 120100

Volume: 100 g
Barcode: 4036231201004
Packaging: 80 pcs.

GREEN



HIGH TEMPERATURE GREASE LC2

art. MR 170300

Volume: 300 g
Barcode: 4036231703003
Packaging: 36 pcs.

art. MR 170100

Volume: 100 g
Barcode: 4036231701009
Packaging: 80 pcs.

BLUE

Heat-resistant high-temperature anti-seize plastic grease, developed using an optimized combination of high-quality mineral oil with a specially selected additive package in an optimally balanced ratio. The product has excellent mechanical stability and thermal stability in a wide range of operating temperatures.

Properties:

Operating temperature range: from -35°C to +170°C. High load resistance minimizes the wear of bearings, helping to increase its resource and reduce maintenance costs. Good water resistance and adhesion to metal surfaces prevents lubrication from washing out.

MÖLDER® TOOLS

PROFESSIONAL TOOL KIT



CR-V 72T 1/4" 1/2"















PROFESSIONAL TOOL KIT

56 PCS

MÖLDER®
TOOLS

CR-V 72T 1/4"



-  1/4": 72T
-  1/4": 150 mm
-  1/4": 150 mm
-  1/4": 110 mm
-  1/4": 50 mm & 100 mm
-  1/4": 6, 7, 8, 9, 10, 11, 12, 13 mm
-  1/4"
-  1/4": 4, 4.5, 5, 5.5, 6, 7, 8, 9, 10, 11, 12, 13 mm
-  1/4": E4, E5, E6, E7, E8, E10 mm
-  1/4" - 3/8"
-  1/4": SL4, SL5.5, SL6.5
-  1/4": PH1, PH2, PH3
-  1/4": PZ1, PZ2, PZ3
-  1/4": H3, H4, H5, H6, H7, H8
-  1/4": T8, T10, T15, T20, T25, T30, T40

art. MT 60056

Professional tool kit: 56 pcs.
Barcode: 4036232600561
Packaging: 6 pcs.

















PROFESSIONAL TOOL KIT

72 PCS

MÖLDER®
TOOLS

CR-V 72T 1/4" 1/2"



-  1/4": 72T; 1/2": 72T
-  1/2": 10, 11, 12, 13, 14, 15, 16, 17, 18, 19, 20, 21, 22, 23, 24, 27 mm
-  1/2": 125 mm & 250 mm
-  1/4": 75 mm
-  1/2" & 1/4"
-  1/2"
-  1/2": 21 mm
-  1/4": 4, 5, 5.5, 6, 7, 8, 10, 11, 12, 13 mm
-  1/4"
-  1/4": 150 mm
-  1.5, 2, 2.5 mm
-  SL3, SL4, SL4.5, SL5, SL6, SL6.5, SL7
-  PH0, PH1, PH2, PH3
-  PZ0, PZ1, PZ2, PZ3
-  S1, S2, S3
-  H2, H3, H4, H5, H5.5, H6
-  T8, T9, T10, T15, T20, T25, T27, T30, T40

art. MT 60072

Professional tool kit: 72 pcs.
Barcode: 4036232600722
Packaging: 4 pcs.

PROFESSIONAL TOOL KIT



82 pcs



CR-V 72T 1/4" 1/2"

- 1/4": 72T; 1/2": 72T
- 1/4": 150 mm
- 1/4": 110 mm
- 1/4": 150 mm
- 1/2": 125 mm & 250 mm
- 1/4": 50 mm & 100 mm
- 1/2": 14, 15, 16, 17, 18, 19, 20, 22, 24, 27, 30, 32 mm
- 1/2"- 5/16"
- 1/2" & 1/4"
- 1/2"
- 1/2": 16 mm & 21 mm
- 1/4": 4, 4.5, 5, 5.5, 6, 7, 8, 9, 10, 11, 12, 13, 14 mm
- 8, 10, 11, 12, 13, 14, 17, 19, 22 mm
- 1/4": SL4, SL5, SL7
- 1/4": PH1, PH2
- 1/4": PZ1, PZ2
- 1/4": H3, H4, H5, H6
- 1/4": T10, T15, T20, T25, T27, T30
- SL6, SL8, SL10
- PH3, PH4
- PZ3, PZ4
- H8, H9, H10, H12, H14
- T30, T40, T45, T50

art. MT 60082

Professional tool kit: 82 pcs.
Barcode: 4036232600829
Packaging: 3 pcs.

PROFESSIONAL TOOL KIT



94 pcs



CR-V 72T 1/4" 1/2"

- 1/4": 72T; 1/2": 72T
- 1/4": 150 mm
- 1/4": 50 mm & 100 mm
- 1/2": 125 mm & 250 mm
- 1/2": 10, 11, 12, 13, 14, 15, 16, 17, 18, 19, 20, 21, 22, 23, 24, 27, 30, 32 mm
- 1/2": 14, 15, 17, 19 mm
- 1/4": 4, 4.5, 5, 5.5, 6, 7, 8, 9, 10, 11, 12, 13, 14 mm
- 1/4": 6, 7, 8, 9, 10, 11, 12, 13 mm
- 1/2"
- 1/2" & 1/4"
- 1/2"
- 1/4": 110 mm
- 1/4": 150 mm
- 1/4": SL4, SL5.5, SL7
- 1/4": PH1, PH2
- 1/4": PZ1, PZ2
- 1/4": H3, H4, H5, H6
- 1/4": T8, T10, T15, T20, T25, T30
- SL8, SL10, SL12
- PH3, PH4
- PZ3, PZ4
- H8, H10, H12, H14
- T40, T45, T50, T55

art. MT 60094

Professional tool kit: 94 pcs.
Barcode: 4036232600940
Packaging: 3 pcs.

PROFESSIONAL TOOL KIT

108 pcs



CR-V 72T 1/4" 1/2"



art. MT 60108

Professional tool kit:
108 pcs.
Barcode: 4036232601085
Packaging: 3 pcs.

- 1/4": 72T; 1/2": 72T
- 1/2": 10, 11, 12, 13, 14, 15, 16, 17, 18, 19, 20, 21, 22, 24, 27, 30, 32 mm
- 1/2": 14, 15, 17, 19, 22 mm
- 1/4": 50 mm & 100 mm
- 1/2": 125 mm & 250 mm
- 1/2" & 1/4"
- 1/2"
- 1/4": 4, 4.5, 5, 5.5, 6, 7, 8, 9, 10, 11, 12, 13, 14 mm
- 1/4": 6, 7, 8, 9, 10, 11, 12, 13 mm
- 1/2": 16 mm & 21 mm
- 1.5, 2, 2.5 mm
- 1/2": E10, E11, E12, E14, E16, E18, E20, E24
- 1/4": E4, E5, E6, E7, E8
- 1/4": 110 mm
- 1/4": 150 mm
- 1/2" - 5/16"
- 1/4": SL4, SL5.5, SL6.5
- 1/4": PH1, PH2
- 1/4": PZ1, PZ2
- 1/4": H3, H4, H5, H6
- 1/4": T8, T10, T15, T20, T25, T27, T30
- SL8, SL10, SL12
- PH3, PH4
- PZ3, PZ4
- H7, H8, H10, H12, H14
- T40, T45, T50, T55, T60

MÖLDER[®] TOOLS



COMBINATION SPANNER



Plastic holder with test mechanism

72-tooth ratchet mechanism

High-quality cardan

Chrome-vanadium steel

Nickel-chrome coating



DIN 3113 national standard of Germany

FLEXIBLE GEAR WRENCH

ART	SIZE	BARCODE	QUANTITY IN THE PACKAGING
MT 57008	8mm	4036231570087	5/200
MT 57009	9mm	4036231570094	5/200
MT 57010	10mm	4036231570100	5/200
MT 57011	11mm	4036231570117	5/200
MT 57012	12mm	4036231570124	5/200
MT 57013	13mm	4036231570131	5/100
MT 57014	14mm	4036231570148	5/100
MT 57015	15mm	4036231570155	5/100
MT 57016	16mm	4036231570162	5/100
MT 57017	17mm	4036231570179	5/100
MT 57018	18mm	4036231570186	5/100
MT 57019	19mm	4036231570193	5/100

FLEXIBLE GEAR WRENCH SET



art. MT 57108

Wrench set: 8 pcs.
Size: 8-10-12-13-
14-15-17-19 mm
Barcode: 4036231571084
Packaging: 5/20 pcs.

art. MT 57110

Wrench set: 10 pcs.
Size: 8-10-12-13-14-15-
16-17-18-19 mm
Barcode: 4036231571107
Packaging: 5/10 pcs.

art. MT 57112

Wrench set: 12 pcs.
Size: 7-8-9-10-12-13-14-
15-16-17-18-19 mm
Barcode: 4036231571121
Packaging: 5/10 pcs.

REVERSIBLE RATCHET WRENCH

ART	SIZE	BARCODE	QUANTITY IN THE PACKAGING
MT 59008	8mm	4036231590085	5/200
MT 59009	9mm	4036231590092	5/200
MT 59010	10mm	4036231590108	5/200
MT 59011	11mm	4036231590115	5/200
MT 59012	12mm	4036231590122	5/200
MT 59013	13mm	4036231590139	5/100
MT 59014	14mm	4036231590146	5/100
MT 59015	15mm	4036231590153	5/100
MT 59016	16mm	4036231590160	5/100
MT 59017	17mm	4036231590177	5/100
MT 59018	18mm	4036231590184	5/100
MT 59019	19mm	4036231590191	5/100

DIN 3113 national standard of Germany



Plastic holder with test mechanism

72-tooth ratchet mechanism



Reverse switch

Chrome-vanadium steel

Nickel-chrome coating

REVERSIBLE RATCHET WRENCH SET



art. MT 59108

Wrench set: 8 pcs.
Size: 8-10-12-13-14-15-17-19 mm
Barcode: 4036231591082
Packaging: 5/20 pcs.

art. MT 59110

Wrench set: 10 pcs.
Size: 8-10-12-13-14-15-16-17-18-19 mm
Barcode: 4036231591105
Packaging: 5/10 pcs.

art. MT 59112

Wrench set: 12 pcs.
Size: 7-8-9-10-12-13-14-15-16-17-18-19 mm
Barcode: 4036232591128
Packaging: 5/10 pcs.

FLAT GEAR WRENCH

ART	SIZE	BARCODE	QUANTITY IN THE PACKAGING
MT 56008	8mm	4036231560088	5/200
MT 56009	9mm	4036231560095	5/200
MT 56010	10mm	4036231560101	5/200
MT 56011	11mm	4036231560118	5/200
MT 56012	12mm	4036231560125	5/200
MT 56013	13mm	4036231560132	5/200
MT 56014	14mm	4036231560149	5/200
MT 56015	15mm	4036231560156	5/100
MT 56016	16mm	4036231560163	5/100
MT 56017	17mm	4036231560170	5/100
MT 56018	18mm	4036231560187	5/100
MT 56019	19mm	4036231560194	5/100

DIN 3113 national standard of Germany



Plastic holder with test mechanism

72-tooth ratchet mechanism



Chrome-vanadium steel

Nickel-chrome coating

FLAT GEAR WRENCH SET



art. MT 56108

Wrench set: 8 pcs.
Size: 8-10-12-13-14-15-17-19 mm
Barcode: 4036231561085
Packaging: 5/20 pcs.

art. MT 56110

Wrench set: 10 pcs.
Size: 8-10-12-13-14-15-16-17-18-19 mm
Barcode: 4036231561108
Packaging: 5/10 pcs.

art. MT 56112

Wrench set: 12 pcs.
Size: 7-8-9-10-12-13-14-15-16-17-18-19 mm
Barcode: 4036231561122
Packaging: 5/10 pcs.

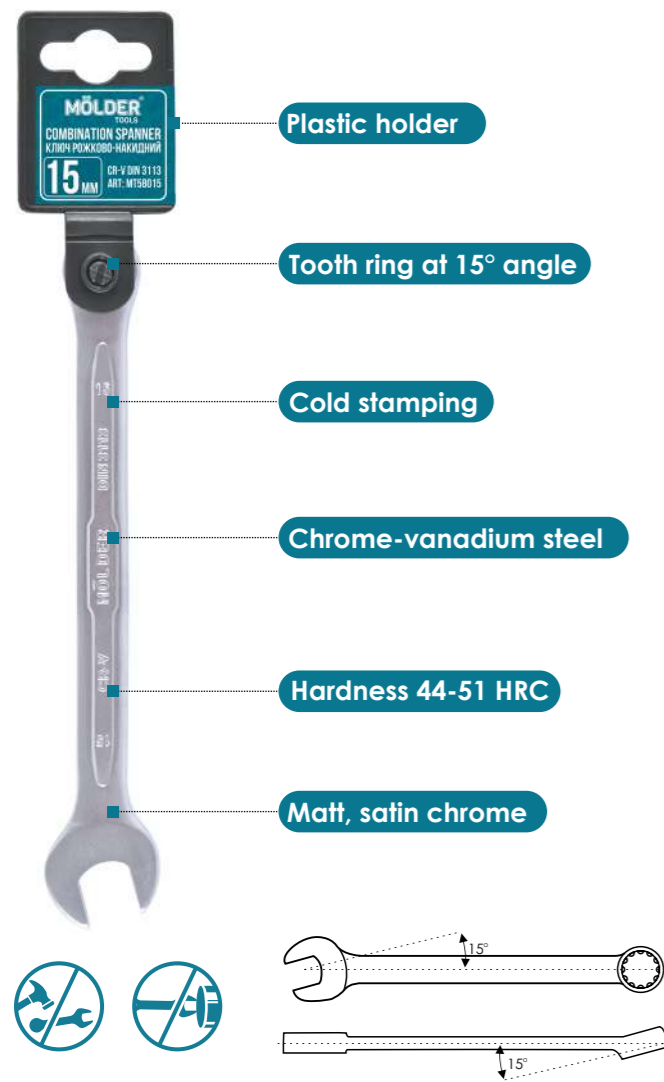

COMBINATION SPANNER

ART	SIZE	BARCODE	QUANTITY IN THE PACKAGING
MT 58006	6mm	4036231580062	10/250
MT 58007	7mm	4036231580079	10/250
MT 58008	8mm	4036231580086	10/250
MT 58009	9mm	4036231580093	10/250
MT 58010	10mm	4036231580109	10/200
MT 58011	11mm	4036231580116	10/200
MT 58012	12mm	4036231580123	10/200
MT 58013	13mm	4036231580130	10/200
MT 58014	14mm	4036231580147	10/150
MT 58015	15mm	4036231580154	10/150
MT 58016	16mm	4036231580161	5/150
MT 58017	17mm	4036231580178	5/100
MT 58018	18mm	4036231580185	5/100
MT 58019	19mm	4036231580192	5/100
MT 58020	20mm	4036231580208	5/50
MT 58021	21mm	4036231580215	5/50
MT 58022	22mm	4036231580222	5/50
MT 58023	23mm	4036231580239	5/50
MT 58024	24mm	4036231580246	5/50
MT 58025	25mm	4036231580253	5/40
MT 58026	26mm	4036231580260	5/40
MT 58027	27mm	4036231580277	5/20
MT 58028	28mm	4036231580284	5/20
MT 58029	29mm	4036231580291	5/20
MT 58030	30mm	4036231580307	5/20
MT 58032	32mm	4036231580321	5/20

DIN 3113 national standard of Germany

COMBINATION SPANNER SET



art. **MT 58108**

Wrench set: 8 pcs.
Size: 8-10-12-13-14-15-17-19 mm
Barcode: 4036231581083
Packaging: 20 pcs.



art. **MT 58112**

Wrench set: 12 pcs.
Size: 6-7-8-9-10-12-13-14-15-17-19-22 mm
Barcode: 4036231581120
Packaging: 10 pcs.



art. **MT 58115**

Wrench set: 15 pcs.
Size: 6-7-8-9-10-11-12-13-14-15-16-17-18-19-22 mm
Barcode: 4036231581151
Packaging: 10 pcs.



art. **MT 58114**

Wrench set: 14 pcs.
Size: 8-10-12-13-14-16-17-19-21-22-24-27-30-32 mm
Barcode: 4036231581144
Packaging: 4 pcs.



art. **MT 58117**

Wrench set: 17 pcs.
Size: 6-7-8-9-10-11-12-13-14-15-16-17-18-19-21-22-24 mm
Barcode: 4036231581175
Packaging: 8 pcs.



art. **MT 58126**

Wrench set: 26 pcs.
Size: 6-7-8-9-10-11-12-13-14-15-16-17-18-19-20-21-22-23-24-25-26-27-28-29-30-32 mm
Barcode: 4036231581267
Packaging: 2 pcs.

FLARE NUT WRENCH

ART	SIZE	BARCODE	QUANTITY IN THE PACKAGING
MT 54010	8x10mm	4036231540103	10/250
MT 54011	9x11mm	4036231540110	10/250
MT 54012	10x12mm	4036231540127	10/250
MT 54014	13x14mm	4036231540141	10/100
MT 54017	15x17mm	4036231540172	10/100



art. **MT 54105**

Wrench set: 5 pcs.
Size: 8x10-9x11-10x12-13x14-15x17 mm
Barcode: 4036231541056
Packaging: 30 pcs.



Plastic holder

Chrome-vanadium steel

Nickel-chrome coating

DIN 3113 national standard of Germany

MÖLDER[®]

FILTER

OIL FILTERS

The main purpose of the oil filter:

- Prevent premature engine wear by removing particles pollution from engine oil;
- Provide optimal supply of clean oil for lubrication;
- Ensure engine components are lubricated in case of filter blockage or «cold start».

Filter material:

- Has a large area and high mechanical strength.
- Effectively filters harmful pollution particles.
- Has the ability to retain particles of pollution during long periods of vehicle operation;
- Resists high temperatures and acidic environment.

Bypass and anti-drainage valves

- Prevent backflow of oil;
- Provide instant oil supply during engine start-up;
- Work in exact accordance with the values of the pressures offered the original manufacturer of the car.

MÖLDER oil filters effectively clean engine oil of contaminations:

- Dust, metal shavings and other fractions, down to the smallest particles with a size of 10 µm (0.01 mm) are carefully removed from the lubrication system;
- The threat of damage and wear of engine structural elements is significantly reduced;
- Due to the purity of the oil and the optimal action of the grease, fuel consumption and emissions of harmful substances are reduced;
- High-quality MÖLDER filters withstand temperatures up to 160°C, while demonstrating resistance to static pressure up to 20 bar.

Our advantages:

- Optimum filtration due to high permeability;
- Ability to withstand pressure and temperature effects in any operating situation;
- High-quality processing and precision connection of filter components ensure flawless operation;
- Perfect fit facilitates installation and guarantees functional reliability;
- The threat of wear and damage to engine structural elements is significantly reduced.



FUEL FILTERS

MÖLDER fuel filters support the operational reliability of the engine and protect the injection system from contamination. The injection systems of modern gasoline and diesel engines instantly react to the slightest fuel contamination. If the fuel filter is not replaced regularly according to the recommendations, it can lead to clogging of the injection systems and a threat to operational safety.

- Due to the fineness of filtration $\geq 2 \mu\text{m}$ (0.002 mm), highly effective removal of contamination particles is ensured, which thus do not enter the injection system.
- In modern injection systems of diesel engines, the filter removes fuel from the water, preventing corrosion damage to the injection system (eg HPPF - high pressure fuel pump).
- Insufficiently filtered fuel can cause malfunction injection systems;

Types of fuel filters

1. Filter cartridges.

The body remains on the engine, only the cartridge needs to be replaced.

The result is a saving of valuable time and material and a contribution to environmental protection.

2. In-line filters.

The body and filter element are a single unit and must be completely replaced as part of maintenance.

3. Trunk filters.

Trunk filters are divided into mesh and paper and are installed in fuel line. Depending on the field of application, the filter housing is made of aluminum, sheet steel or polymer materials.

Our advantages:

- Thanks to precise and high-quality processing, MÖLDER fuel filters withstand a peak pressure of 15 bar;
- Optimum filtration and a higher degree of purification thanks to the use of high-quality filter materials;
- Significant increase in replacement intervals;
- Injection units and the engine are under protection;
- Insensitivity even to aggressive types of fuel and to high injection pressure.



www.molderfilter.de

AIR FILTERS

High-quality MÖLDER **air filters** protect the engine and electronic components, efficiently and reliably cleaning the air. For both gasoline and diesel engines, the air filter is the most important. Depending on the power, the engine of a commercial vehicle sucks up to 1,500 m³ of air per hour, with a particle content of up to 50 mg/m³. The MÖLDER air filter ensures the delivery of an optimally dosed fuel-air mixture, and therefore the best possible combustion.

- Modern high-quality MÖLDER air filters reach almost 100 percent degree of purification, thereby guaranteeing effectiveness throughout interval between maintenance.
- Due to high pulsation resistance, the filters do not pass dust even in dynamic conditions of engine operation.
- Without reliable filtration, airborne particles can settle on the mass air flow sensor and cause power loss and increased fuel consumption.
- Reliable filtration in the long run ensures smooth engine operation and extends service life.

Filter cartridges:

The air filter is the central element of the entire air supply system and can look like a cartridge of any shape. In some cases, various structures are equipped with stabilizing rods or gratings.

Our advantages:

- Protection against wear and increase in engine service life due to excellent filtration of impurities;
- High accuracy of landing and stability ensure 100 percent tightness and long-term functional reliability;
- Flame retardant materials prevent fire;
- Thanks to high-quality special impregnation filter paper withstands pressure and does not tear even in wet weather;
- The special corrugation of the paper ensures maximum stability of the filter and prevents the folds from shifting.



CABIN AIR FILTERS

MÖLDER **cabin filters** clean the air and provide a healthy, hygienic atmosphere in the car, helping the driver not to lose concentration. In order for the air conditioner to work flawlessly for a long time, it is recommended to replace the cabin filter regularly: at least annually, as the basic rule indicates, and twice a year for intensive driving. Replacement contributes not only to the maintenance of air quality in the car, but also to the careful handling of the car's fan motor, because in this way the air flow will be able to flow unhindered.

- The salon filter effectively traps dust, various allergens and unpleasant odors are removed from the air by almost 100 percent.
- Particles up to 3 µm (0.003 mm) in size are effectively retained.
- A layer of activated carbon acts like a sponge and holds back harmful gases - in pores that are 10,000 times thinner than a human hair.
- The content of harmful fine dust in the car interior is steadily decreasing

Types of cabin filters

1. Cabin filters (Standard).

Spores, pollen and dust are effectively retained, as well as bacteria, fungi and abrasive particles. In the dense plexus of filter fibers, particles are mechanically filtered out of the air stream.

2. Filters with activated carbon (Carbon).

In addition, the filter design contains granules of activated carbon, which are located between the upper and lower layers of the fiber. In addition to abrasive particles, activated carbon traps harmful gases, such as nitrogen oxides, methane, and ozone.

Principle of operation:

The interior filter prevents any particles from entering the interior of the car. An activated carbon filter additionally traps unpleasant odors and gaseous harmful substances.

Our advantages:

- The maximum degree of purification - for healthy air in the car;
- Constant level of filtration efficiency during the entire interval between maintenance;
- Prevention of the formation of condensate and a layer of dirt on the windshield;
- Minimization of unpleasant odors.



BELAUTO®

Manufactured in accordance with high quality standards of BELAUTO®



BURAN

art.BK46

Max. Air Flow Rate
90 l/min

Power Rate
380 W

Power cable made of 100% copper and 30A fuse

Switch power button with built-in thermal protection relay against overheating of the electric motor

High-quality clamps for reliable and strong fixation on battery terminals

Reliable metal connector with a convenient holder

Natural rubber hose

Stabilizer stand

Hose made of high-quality frost-resistant PU material
5,7 m

High-precision metal manometer with additional rubber protection

Deflator valve for overpressure relief

Additional adapters and fuse

Powerful motor with high-quality double winding with 100% copper ensures long-term operation without overheating

Voltage	DC 12 V
Max. Current	30 A
Max. Pressure	10 Atm. (kg/cm ²)
Continuous operating time	30 min.
Max. Air Flow Rate	90 l/min
Working Ambient Temperature	-30°C +80°C
Hose Length	5.7 m
Power Cord Length	2.4 m
Packaging	4 pcs.
Barcode	5901292744670

Moisture-resistant bag made of high-quality material

Convenient handle for carrying



HEAVY DUTY PROFESSIONAL AIR COMPRESSOR

Max. Air Flow Rate
160 l/min

Power Rate
600 W

Heavy duty automatic relay switch

Rubberized protection for the power button

High-quality clamps for reliable and strong fixation on battery terminals

Reliable metal connector with a convenient holder



Additional adapters



Moisture-resistant bag made of high-quality material



TROPHI

art.BK47

24 months guarantee

Cylinder diameter
60 mm

Hose made of high-quality frost-resistant PU material
8 m

High-precision metal manometer with additional rubber protection

Deflator valve for overpressure relief

Natural rubber hose

Stabilizer stand

Convenient handle for carrying

Bypass valve

BELAUTO®
TROPHI



Powerful motor with high-quality double winding with 100% copper ensures long-term operation without overheating

Voltage	DC 12 V
Max. Current	45 A
Max. Pressure	10 Atm. (kg/cm ²)
Continuous operating time	30 min.
Max. Air Flow Rate	160 l/min
Working Ambient Temperature	-30°C +80°C
Hose Length	8 m
Power Cord Length	2.4 m
Packaging	2 pcs.
Barcode	5901292744748

MUROMETS-2

art.BK43A

Max. Air Flow Rate

40 l/min

Power Rate

170 W



HEAVY DUTY SINGLE CYLINDER AIR COMPRESSOR WITH AUTO STOP FUNCTION



DIGITAL MANOMETER
LED BACKLIGHT
FUNCTION AUTOSTOP



Rubber cushioning support for improved stability and vibration absorption

Reliable metal connector with a convenient holder

Plug with a fuse made of high-quality plastic

Natural rubber hose

Power cable with 100% copper



Metal connecting rod with bearing pair



Enlarged motor with 100% copper winding provides high performance and long operation without overheating



Additional adapters and fuse

Powerful motor with high-quality double winding with 100% copper ensures long-term operation without overheating

Voltage	DC 12 V
Max. Current	15 A
Max. Pressure	10 Atm. (kg/cm ²)
Continuous operating time	20 min.
Max. Air Flow Rate	40 l/min.
Working Ambient Temperature	-30°C +80°C
Hose Length	1 m
Power Cord Length	3 m
Packaging	6 pcs.
Barcode	5901292704384



Moisture-resistant bag made of high-quality material

ZENIT

art.BK49

Max. Air Flow Rate

40 l/min

Power Rate

170 W



HEAVY DUTY SINGLE CYLINDER AIR COMPRESSOR



High-precision metal manometer



Convenient handle for carrying

Rubber cushioning support for improved stability and vibration absorption

Reliable metal connector with a convenient holder

Natural rubber hose

Plug with a fuse made of high-quality plastic



Easy fixation of the hose and power cable on the body for convenient storage



Additional adapters and fuse

Powerful motor with high-quality double winding with 100% copper ensures long-term operation without overheating

Voltage	DC 12 V
Max. Current	14 A
Max. Pressure	10 Atm. (kg/cm ²)
Continuous operating time	15 min.
Max. Air Flow Rate	40 l/min
Working Ambient Temperature	-30°C +80°C
Hose Length	1 m
Power Cord Length	3 m
Packaging	8 pcs.
Barcode	5901292744984



Moisture-resistant bag made of high-quality material

MUROMETS

art.BK43



HEAVY DUTY SINGLE CYLINDER AIR COMPRESSOR

Voltage: DC 12 V
 Max. Current: 14 A
 Max. Pressure: 10 Atm
 Continuous operating time: 20 min.
 Max. Air Flow Rate: 40 l/min
 Hose Length: 1 m
 Power Cord Length: 3 m
 Packaging: 6 pcs.
 Barcode: 5901292744366



Moisture-resistant bag made of high-quality material

TWO CYLINDER HEAVY DUTY AIR COMPRESSOR

Voltage: DC 12 V
 Max. Current: 30 A
 Max. Pressure: 10 Atm
 Continuous operating time: 20 min.
 Max. Air Flow Rate: 90 l/min.
 Hose Length: 5,7 m
 Power Cord Length: 2,4 m
 Packaging: 4 pcs.
 Barcode: 5901292744502

ZUBR

art.BK45



fuse 30A

high quality PU hose 5,7m

with battery clamps



Moisture-resistant bag made of high-quality material

Additional adapters and fuse

RECORD

art.BK31

HEAVY DUTY SINGLE CYLINDER AIR COMPRESSOR

Voltage: DC 12 V
 Max. Current: 14 A
 Max. Pressure: 10 Atm
 Continuous operating time: 20 min.
 Max. Air Flow Rate: 37 l/min
 Hose Length: 1 m
 Power Cord Length: 3 m
 Packaging: 6 pcs.
 Barcode: 5901292744311



Moisture-resistant bag made of high-quality material

RECORD-2

art.BK32

Voltage: DC 12 V
 Max. Current: 14 A
 Max. Pressure: 10 Atm
 Continuous operating time: 20 min.
 Max. Air Flow Rate: 37 l/min
 Hose Length: 1 m
 Power Cord Length: 3 m
 Packaging: 6 pcs.
 Barcode: 5901292744328

HEAVY DUTY SINGLE CYLINDER AIR COMPRESSOR



Moisture-resistant bag made of high-quality material



Metal radiator

URAL

art.BK41



Additional adapters and fuse

with LED flashlight

HEAVY DUTY SINGLE CYLINDER AIR COMPRESSOR

Voltage: DC 12 V
 Max. Current: 14 A
 Max. Pressure: 10 Atm
 Continuous operating time: 20 min.
 Max. Air Flow Rate: 40 l/min.
 Hose Length: 5,7 m
 Power Cord Length: 3 m
 Packaging: 6 pcs.
 Barcode: 5901292744120

high quality hose 5,7m

HEAVY DUTY SINGLE CYLINDER AIR COMPRESSOR

URAL-2

art.BK42



Additional adapters and fuse

Voltage: DC 12 V
 Max. Current: 14 A
 Max. Pressure: 10 Atm
 Continuous operating time: 20 min.
 Max. Air Flow Rate: 40 l/min.
 Hose Length: 1,3 m
 Power Cord Length: 3 m
 Packaging: 6 pcs.
 Barcode: 5901292744298

URAL-3

art.BK44



with battery clamps

HEAVY DUTY SINGLE CYLINDER AIR COMPRESSOR

Voltage: DC 12 V
 Max. Current: 14 A
 Max. Pressure: 10 Atm
 Continuous operating time: 20 min.
 Max. Air Flow Rate: 40 l/min.
 Hose Length: 5,7 m
 Power Cord Length: 3 m
 Packaging: 6 pcs.
 Barcode: 5901292744434



Additional adapters and fuse

SPUTNIK

art.BK48

HEAVY DUTY SINGLE CYLINDER AIR COMPRESSOR

Max. Air Flow Rate

32 l/min

Power Rate

150 W



Manometer with additional rubber protection

Reliable and convenient metal handle

Reliable metal connector with a convenient holder

Plug with a fuse made of high-quality plastic

Rubber cushioning support for improved stability and vibration absorption

Natural rubber hose



Additional adapters and fuse



Moisture-resistant bag made of high-quality material

Powerful motor with high-quality double winding with 100% copper ensures long-term operation without overheating

Voltage	DC 12 V
Max. Current	12 A
Max. Pressure	7 Atm. (kg/cm ²)
Continuous operating time	20 min.
Max. Air Flow Rate	32 l/min.
Working Ambient Temperature	-30°C +80°C
Hose Length	1 m
Power Cord Length	3 m
Packaging	8 pcs.
Barcode	5901292744816

**HAND PUMP
art. BL47**

Cylinder size: 38x480 mm
Material of cylinder: steel
Max. Pressure: 10 Atm
Hose Length: 65 cm
Packaging: 10 pcs.
Barcode: 5901292847180

ergonomic plastic handle



hose made of natural rubber is resistant to low temperatures

hose made of natural rubber is resistant to low temperatures



high precision manometer



additional adapters in the box



convenient plastic connector



reliable highly efficient piston



strong and reliable base from primary raw materials



**HAND PUMP
art. BL46**

Cylinder size: 38x480 mm
Material of cylinder: steel
Max. Pressure: 10 Atm
Hose Length: 70 cm
Packaging: 10 pcs.
Barcode: 5901292846190



**HAND PUMP
art. BL45**

Cylinder size: 38x430 mm
Material of cylinder: steel
Max. Pressure: 10 Atm
Hose Length: 60 cm
Packaging: 10 pcs.
Barcode: 5901292845100



**HAND PUMP
art. BL44**

Cylinder size: 32x480 mm
Material of cylinder: steel
Max. Pressure: 10 Atm
Hose Length: 60 cm
Packaging: 10 pcs.
Barcode: 5901292844110



**HAND PUMP
art. BL42**

Cylinder size: 38x540 mm
Material of cylinder: aluminum
Max. Pressure: 10 Atm
Hose Length: 65 cm
Packaging: 10 pcs.
Barcode: 5901292754266



TECHNICAL DETAILS OF HAND PUMPS

	BL47	BL46	BL45	BL44	BL42
CYLINDER SIZE, mm	38x480	38x480	38x430	32x480	38x540
MATERIAL OF CYLINDER	steel	steel	steel	steel	aluminum
MAX. PRESSURE, Atm	10	10	10	10	10
HOSE LENGTH, mm	650	700	600	600	650

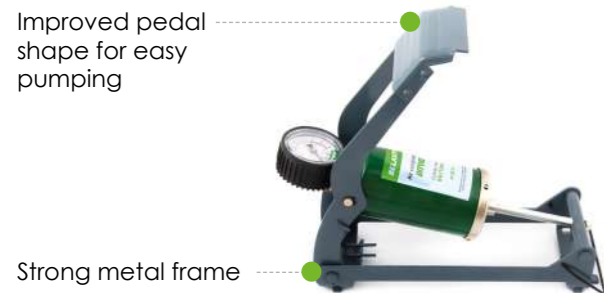

VITYAZ

FOOT PUMP art. BL12

Volume of cylinder: 400 cm³
 Max. Pressure: 10 Atm
 Hose Length: 60 cm
 Weight: 1,6 kg
 Packaging: 8 pcs.
 Barcode: 5901292741228

FOOT PUMP art. BL11

Volume of cylinder: 500 cm³
 Max. Pressure: 6 Atm
 Hose Length: 60 cm
 Weight: 1,8 kg
 Packaging: 10 pcs.
 Barcode: 5901292741150



Metal high precision manometer



Metal high precision manometer

START
FOOT PUMP art. BL21

Volume of cylinder: 330 cm³
 Max. Pressure: 10 Atm
 Hose Length: 60 cm
 Weight: 1,4 kg
 Packaging: 10 pcs.
 Barcode: 5901286579523

METAL JERRY CAN art. KS20

Volume: 20 L
 Packaging: 4 pcs.
 Barcode: 5901292292072

The seamless welded handle ensures the integrity and strength of the canister



Powder coating protects the canister from rust and provides a smooth finish

The inner coating is resistant to fuel greases and corrosion



METAL JERRY CAN art. KS10

Volume: 10 L
 Packaging: 4 pcs.
 Barcode: 5901292291082



Air tube

A reliable lidprovides protection against leakage in any position of the canister

Pressed seal made of high-quality rubber

Strong welds

Reinforced bottom



METAL JERRY CAN art. KS05

Volume: 5 L
 Packaging: 5 pcs.
 Barcode: 5901292290542

CYCLONE

art. BA58B

4500 Pa
SUCTION POWER

150 W
POWER RATE

CAR VACUUM CLEANER
FOR WET & DRY CLEANING



Additional nozzles



BRUSH FOR SEATS
Suitable for dusting seats and other interior textile elements.



CREVICE SUCTION TOOL
Helps to clean the surface in hard-to-reach places: crevices, niches, corners and narrow openings. It is used for cleaning liquids.



EXTENSION PIPE
Can be used with other nozzles for easy cleaning.



ROUND BRUSH
Suitable for dusting shaped and uneven surfaces, as well as textile elements of the interior.



The bag is made of high-quality material

FILTRATION TECHNOLOGY

PRO CYCLONE SYSTEM
▪ STAINLESS STEEL FILTER
▪ 3-STAGE FILTRATION

- Doesn't need filter cleaning
- Doesn't lose suction power

Voltage	DC 12 V
Power Rate	150 W
Dustbin capacity	600 ml
Cord length	4 m
Suction power	4500 Pa
Fuse	15 A
Filter	HEPA
Barcode	5901292858148
Packaging	6 pcs.

SMERCH

art. BA56B

CAR VACUUM CLEANER
FOR WET & DRY CLEANING

150 W
POWER RATE

Voltage: DC 12 V
Power Rate: 150 W
Dustbin capacity: 500 ml
Cord length: 4 m
Suction power: 4500 Pa
Fuse: 15 A
Filter: HEPA
Packaging: 6 pcs.
Barcode: 5901292856168

FILTRATION TECHNOLOGY

POWER CYCLONE
▪ HEPA FILTER ▪ 2-STAGE FILTRATION

- Doesn't need filter cleaning
- Doesn't lose suction power



The bag is made of high-quality material

SMERCH-2

art. BA57B

Voltage: DC 12 V
Power Rate: 150 W
Dustbin capacity: 500 ml
Cord length: 4 m
Suction power: 4500 Pa
Fuse: 15 A
Filter: HEPA
Packaging: 6 pcs.
Barcode: 5901292857158

FILTRATION TECHNOLOGY

POWER CYCLONE
▪ HEPA FILTER ▪ 2-STAGE FILTRATION

- Doesn't need filter cleaning
- Doesn't lose suction power



The bag is made of high-quality material and additional nozzles

CAR VACUUM CLEANER
FOR WET & DRY CLEANING

150 W
POWER RATE

TORNADO



Filtration technology
«CYCLONE»

- Doesn't need filter cleaning
- Doesn't lose suction power

110 W
POWER RATE

CAR VACUUM CLEANER

art. BA53

**WET & DRY
CLEANING**



Voltage	DC12 V
Power Rate	110 W
Dustbin capacity	300 ml
Cord length	5 m
Motor	32000 r/min
Fuse	15 A
Filter	HEPA
Barcode BA53 White	5901292753276
Barcode BA53 Black	5901292753108
Packaging	20 pcs.

Additional nozzles



BRUSH
Suitable for dusting shaped and uneven surfaces, as well as textile elements of the interior.



EXTENSION PIPE
Can be used with other nozzles for easy cleaning.



CREVICE SUCTION TOOL
Helps to clean the surface in hard-to-reach places: crevices, niches, corners and narrow openings. It is used for cleaning liquids.



The bag is made of high-quality material

STORM

art. BA54

Filtration technology
«CYCLONE»

- Doesn't need filter cleaning
- Doesn't lose suction power

CAR VACUUM CLEANER
FOR WET & DRY CLEANING

110 W
POWER RATE

Voltage: DC 12 V
Power Rate: 110 W
Dustbin capacity: 300 ml
Cord length: 5 m
Suction power: 3200 Pa
Fuse: 15 A
Filter: HEPA
Packaging: 20 pcs.
Barcode: 5901292854188



The bag is made of high-quality material and additional nozzles



TYPHOON

art. BA55

Filtration technology
«CYCLONE»

- Doesn't need filter cleaning
- Doesn't lose suction power

CAR VACUUM CLEANER
FOR WET & DRY CLEANING

110 W
POWER RATE

Voltage: DC 12 V
Power Rate: 110 W
Dustbin capacity: 300 ml
Cord length: 5 m
Suction power: 3200 Pa
Fuse: 15 A
Filter: HEPA
Packaging: 20 pcs.
Barcode: 5901292855178



The bag is made of high-quality material and additional nozzles



LED flashlight



HYDRAULIC BOTTLE JACK

5T

art. DB05

Technical details:

Lifting capacity: 5 т
 Type: hydraulic (telescopic)
 Maximum lift height: 380 mm
 Minimum height: 195 mm
 Type of packaging: colour box
 Packaging: 5 pcs.
 Barcode: 5901292300500

The hydraulic telescopic jack is used to lift heavy objects to a certain height, but not for long-term holding in this position. Hydraulic jacks have a high level of efficiency and very high reliability of operation.

- It is used for lifting a car weighing up to 5 tons
- The hydraulic lifting system of increased reliability has a high efficiency
- An ideal combination of high structural rigidity and compactness
- Has a smooth flow. Provides even rise up
- Simple and convenient to use

The two-layer coating reliably protects BELAUTO jacks from corrosion and can be quickly cleaned of dirt. The jack uses universal seals and gaskets that can be easily replaced. All parts of the jacks are perfectly assembled, which indicates quality and reliability.



HYDRAULIC BOTTLE JACK

5T

art. DB05P

Lifting height: 195-380 mm
 Lifting capacity: 5 т
 Type of packaging: plastic case
 Packaging: 5 pcs.
 Barcode: 5901292310578



Jacks are made from primary high-quality raw materials. High reliability is confirmed by the received European quality certificates.

The product meets all basic requirements of EU directives



The product has been checked for quality, tested and approved for safety by GS TÜV Rheinland Product Safety GmbH (Germany).



HYDRAULIC BOTTLE JACK

2T

art. DB02

Lifting height: 148-278 mm
 Lifting capacity: 2 т
 Type of packaging: colour box
 Packaging: 10 pcs.
 Barcode: 5901292300296



HYDRAULIC BOTTLE JACK

2T

art. DB02P

Lifting height: 148-278 mm
 Lifting capacity: 2 т
 Type of packaging: plastic case
 Packaging: 5 pcs.
 Barcode: 4818669231026

HYDRAULIC BOTTLE JACK

3T

art. DB03

Lifting height: 180-340 mm
 Lifting capacity: 3 т
 Type of packaging: colour box
 Packaging: 5 pcs.
 Barcode: 5901292300364



HYDRAULIC BOTTLE JACK

3T

art. DB03P

Lifting height: 180-340 mm
 Lifting capacity: 3 т
 Type of packaging: plastic case
 Packaging: 5 pcs.
 Barcode: 5901292310332

HYDRAULIC BOTTLE JACK

8T

art. DB08

Lifting height: 200-385 mm
 Lifting capacity: 8 т
 Type of packaging: colour box
 Packaging: 4 pcs.
 Barcode: 5901292300814



HYDRAULIC BOTTLE JACK

10T

art. DB10

Lifting height: 200-385 mm
 Lifting capacity: 10 т
 Type of packaging: colour box
 Packaging: 4 pcs.
 Barcode: 5901292301040



HYDRAULIC BOTTLE JACK
16T
art. DB16

Lifting height: 220-420 mm
Lifting capacity: 16 т
Type of packaging: colour box
Packaging: 2 pcs.
Barcode: 5901292301668



HYDRAULIC BOTTLE JACK
20T
art. DB20

Lifting height: 190-350 mm
Lifting capacity: 20 т
Type of packaging: colour box
Packaging: 2 pcs.
Barcode: 5901292302030



HYDRAULIC BOTTLE JACK
32T
art. DB32

Lifting height: 194-344 mm
Lifting capacity: 32 т
Type of packaging: colour box
Packaging: 1 pc.
Barcode: 5901292303266



HYDRAULIC BOTTLE JACK
50T
art. DB50

Lifting height: 285-465 mm
Lifting capacity: 50 т
Type of packaging: colour box
Packaging: 1 pc.
Barcode: 5901292305000

TECHNICAL DETAILS OF HYDRAULIC BOTTLE JACKS

- DB02 DB03 DB05 DB08 DB10 DB16 DB20 DB32 DB50
DB02P DB03P DB05P

	2	3	5	8	10	16	20	32	50
LIFTING CAPACITY, T	2	3	5	8	10	16	20	32	50
MAX. LIFTING HEIGHT, mm	278	340	380	385	385	420	350	344	465
LIFTING HEIGHT, mm	130	160	185	185	185	200	160	150	180
MIN. LIFTING HEIGHT, mm	148	180	195	200	200	220	190	194	285

HYDRAULIC FLOOR JACK

2T art. DP28

Lifting height: 130-330 mm
Lifting capacity: 2 т
Type of packaging: colour box
Packaging: 1 pc.
Barcode: 5901292302894



HYDRAULIC FLOOR JACK

2T art. DP28P

Lifting height: 130-330 mm
Lifting capacity: 2 т
Type of packaging: plastic case
Packaging: 1 pc.
Barcode: 5901292312862



PROFESSIONAL HYDRAULIC FLOOR JACK

3T
art. DP33

Max. lifting height: 490 mm
Min. lifting height: 130 mm
Lifting height: 360 mm
Lifting capacity: 3 т
Jack weight: 28 kg
Type of packaging: colour box
Packaging: 1 pc.
Barcode: 5901292313302



pedal for quick lifting

PROFESSIONAL HYDRAULIC FLOOR JACK

3T
art. DP35

Max. lifting height: 490 mm
Min. lifting height: 130 mm
Lifting height: 360 mm
Lifting capacity: 3 т
Jack weight: 28 kg
Type of packaging: colour box
Packaging: 1 pc.
Barcode: 5901292313548

SCISSOR JACK

1,5T

art. DM15T

Lifting height: 110-390 mm
 Lifting capacity: 1,5 t
 Type of packaging: colour box
 Packaging: 6 pcs.
 Barcode: 5901292411558

- A scissor jack is used to lift heavy objects to a certain height, but not to hold them in this position for a long time. It has a high level of efficiency and very high reliability of operation.
- The device is characterized by convenience and safety of operation, as well as ease of lifting loads.
- BELAUTO scissor jacks are made of high-quality metal and manufactured on the most modern equipment.

12
MONTHS
GUARANTEE



390mm
max.
110mm
min.

SCISSOR JACK

1,5 T

art. DM15

Lifting height: 110-390 mm
 Lifting capacity: 1,5 t
 Type of packaging: colour box
 Packaging: 6 pcs.
 Barcode: 5901292401580

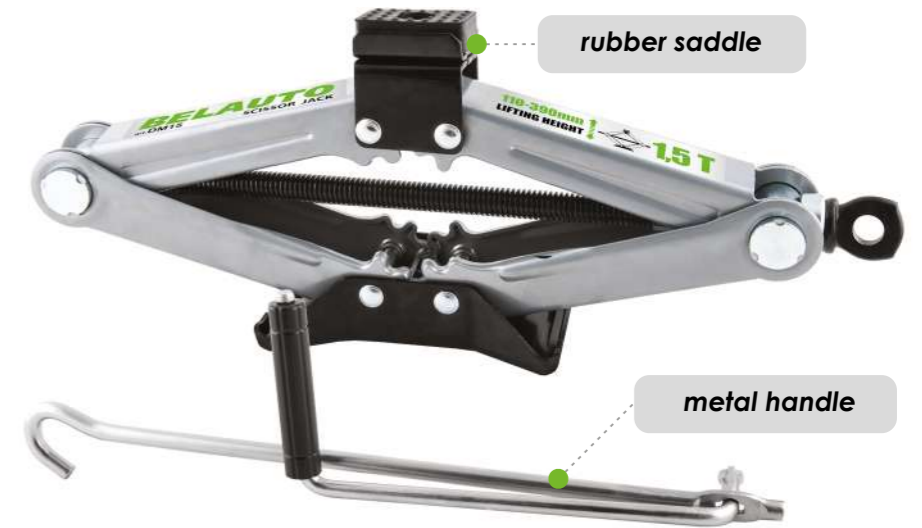

SCISSOR JACK

2T

art. DM20T

Lifting height: 120-413 mm
 Lifting capacity: 2 t
 Type of packaging: colour box
 Packaging: 6 pcs.
 Barcode: 5901292412098

SCISSOR JACK

2T

art. DM20

Lifting height: 120-413 mm
 Lifting capacity: 2 t
 Type of packaging: colour box
 Packaging: 6 pcs.
 Barcode: 5901292402020



BOOSTER CABLES

FOR LARGE TRUCKS



The case is convenient for carrying and storing

art. **BP100**

STARTING CURRENT **1000Amp**

Cables length: 7 m
Weight: 5,7 kg
Packaging: 2 pcs.
Barcode: 5901292710088

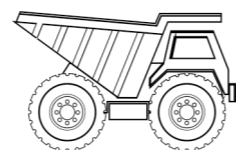

Frost-resistant up to -40°C and elastic cable with high-quality TPE insulation



Full insulated handle clamps

High-quality and reliable connection of wires with clamps



CCA Stranded Wires

Starting current: 300 Amp
Cables length: 2,5 m
Petrol engine: up to 3000 cm³
Diesel engine: up to 2500 cm³
Weight: 0,9 kg
Packaging: 10 pcs.
Barcode: 5901292753030



BOOSTER CABLES

300Amp

art. **BP30**



BOOSTER CABLES

400A

art. **BP40**

Starting current: 400 Amp
Cables length: 3 m
Petrol engine: up to 3500 cm³
Diesel engine: up to 3000 cm³
Weight: 1,1 kg
Packaging: 10 pcs.
Barcode: 5901292754020

Starting current: 500 Amp
Cables length: 3,5 m
Petrol engine: up to 4000 cm³
Diesel engine: up to 3500 cm³
Weight: 1,5 kg
Packaging: 8 pcs.
Barcode: 5901292755010



BOOSTER CABLES

500Amp

art. **BP50**

FOR LARGE TRUCKS

Starting current: 600 Amp
Cables length: 5 m
Weight: 2,1 kg
Packaging: 6 pcs.
Barcode: 5901292756000



BOOSTER CABLES

600Amp

art. **BP60**

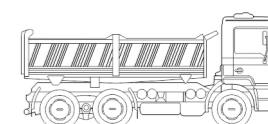

BOOSTER CABLES

800Amp

art. **BP80**

Starting current: 800 Amp
Cables length: 6 m
Weight: 3,2 kg
Packaging: 6 pcs.
Barcode: 5901292758080



RATCHET TIE DOWN 1000kg (4m; 6m)

art. **BC1-4**
Barcode: 5901292701482
art. **BC1-6**
Barcode: 5901292701628

Break strength: 1000 kg
Total length: 4/6 m
Material: polyester 100%
Weight: 0,6 / 0,7 kg

STRETCHING < 7%



RATCHET TIE DOWN 1500kg (5m; 7m)



art. **BC15-5**
Barcode: 5901292715588
art. **BC15-7**
Barcode: 5901292715724

Break strength: 1500 kg
Total length: 5/7 m
Material: polyester 100%
Weight: 0,7 / 0,8 kg

STRETCHING < 7%

RATCHET TIE DOWN 2000kg (4m; 6m; 8m)

art. **BC2-4**
Barcode: 5901292702472
art. **BC2-6**
Barcode: 5901292702618
art. **BC2-8**
Barcode: 5901292702854

Break strength: 2000 kg
Total length: 4/6/8 m
Material: polyester 100%
Weight: 0,9 / 1 / 1,1 kg

STRETCHING < 7%



RATCHET TIE DOWN 3000kg (6m; 8m)

art. **BC3-6**
Barcode: 5901292703608
art. **BC3-8**
Barcode: 5901292703844

Break strength: 3000 kg
Total length: 6/8 m
Material: polyester 100%
Weight: 1,3 / 1,5 kg

STRETCHING < 7%

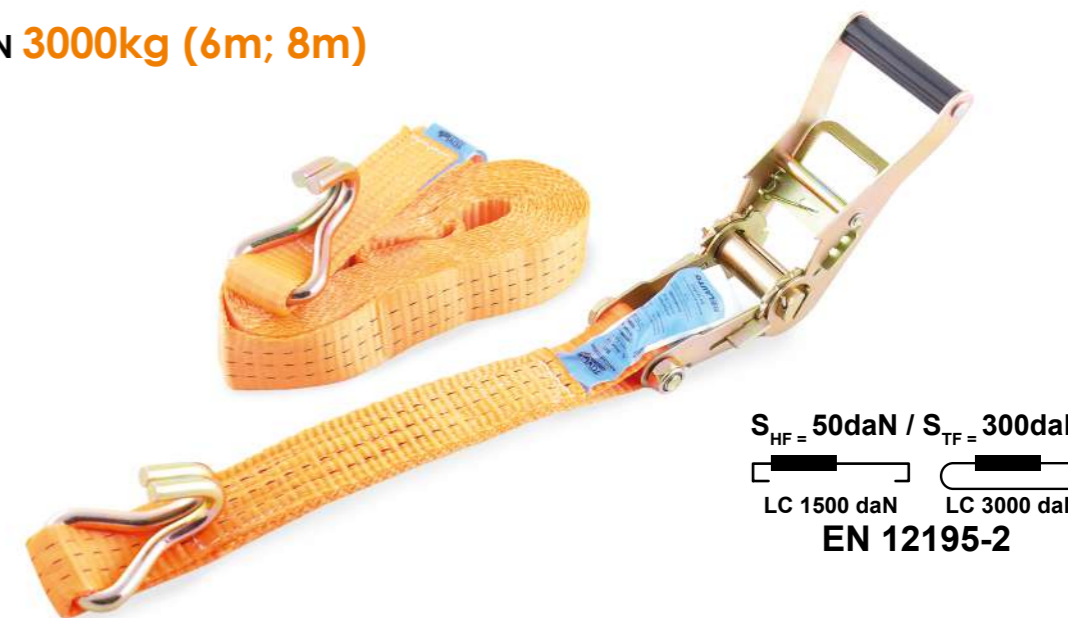

RATCHET TIE DOWN 5000kg (8m; 10m; 12m; 14m)



art. **BC5-8**
Barcode: 5901292705824
art. **BC5-10**
Barcode: 5901292705060
art. **BC5-12**
Barcode: 5901292705206
art. **BC5-14**
Barcode: 5901292705442

Break strength: 5000 kg
Total length: 8/10/12/14 m
Material: polyester 100%
Weight: 2,5 / 2,7 / 2,9 / 3,1 kg

STRETCHING < 7%

RATCHET TIE DOWN 6000kg (10m; 12m)

art. **BC6-10**
Barcode: 5901292706050
art. **BC6-12**
Barcode: 5901292706296

Break strength: 6000 kg
Total length: 10/12 m
Material: polyester 100%
Weight: 2,7 / 2,9 kg

STRETCHING < 7%



TOW ROPE 3,5T (5m)
art. **BT35-5**



Max load capacity: 3500 kg
Tow length: 5 m
Material: polyester 100%
Weight: 1,1 kg
Packaging: 20 pcs.
Barcode: 5901292735524



TOW ROPE 5,5T (5m)
art. **BT55-5**



Max load capacity: 5500 kg
Tow length: 5 m
Material: polyester 100%
Weight: 1,3 kg
Packaging: 20 pcs.
Barcode: 5901292755560

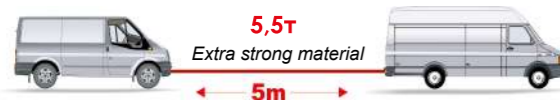

TOW ROPE 8T (6m)
art. **BT80-6**



Max load capacity: 8000 kg
Tow length: 6 m
Material: polyester 100%
Weight: 2,4 kg
Packaging: 10 pcs.
Barcode: 5901292780692

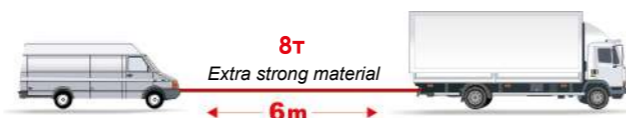

TOW ROPE 4,5T (5m)
art. **BT45-5**



Max load capacity: 4500 kg
Tow length: 5 m
Material: polyester 100%
Weight: 1,1 kg
Packaging: 20 pcs.
Barcode: 5901292745592

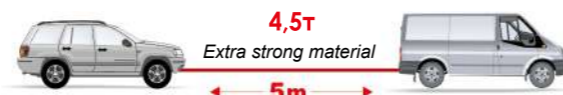

TOW ROPE 6,5T (6m)
art. **BT65-6**



Max load capacity: 6500 kg
Tow length: 6 m
Material: polyester 100%
Weight: 1,8 kg
Packaging: 10 pcs.
Barcode: 5901292765606

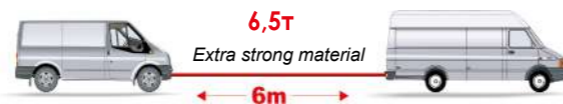

MAGNETIC
CAR PHONE HOLDER
art. **DU24**

Barcode: 5901292792404
Packaging: 100 pcs.



55mm
STRONG MAGNET

Powerful neodymium magnet

110-220 mm



Easy adjust holder and high-quality plastic is resistant to sunlight

A high-quality silicone suction cup and a vacuum valve firmly fix the holder on the glass and dashboard

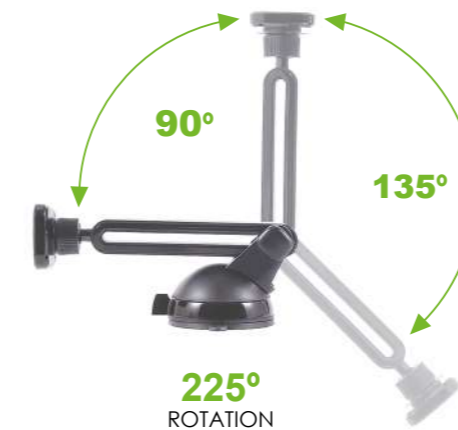

Two metal plates under the cover with double-sided tape

MAGNETIC CAR PHONE HOLDERS AIR VENT MOUNT

art. **DU21**

Barcode: 5901292792190
Packaging: 200 pcs.



art. **DU22**

Barcode: 5901292792268
Packaging: 100 pcs.



art. **DU31**

Barcode: 5901292793180
Packaging: 200 pcs.



GRAVITY CAR PHONE HOLDERS AIR VENT MOUNT

art. **DU23**

Barcode: 5901292792336
Packaging: 60 pcs.



68-90 mm
COMPATIBLE WITH
PHONE WIDTH



AUTOMATIC
LOCKING



UNIVERSAL CAR PHONE HOLDERS

art. **DU13**

Barcode: 5901292791346
Packaging: 30 pcs.



58-90 mm
COMPATIBLE WITH
PHONE WIDTH

art. **DU15**

Barcode: 5901292791582
Packaging: 60 pcs.

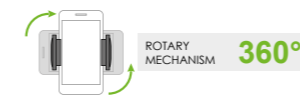

58-90 mm
COMPATIBLE WITH
PHONE WIDTH



art. **DU17**

Barcode: 5901292791728
Packaging: 100 pcs.

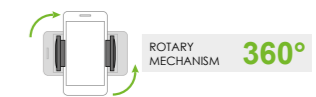

54-80 mm
COMPATIBLE WITH
PHONE WIDTH



UNIVERSAL CAR PHONE HOLDERS

art. **DU19**

Barcode: 5901292791964
Packaging: 60 pcs.

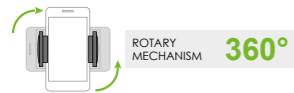

51-98 mm
COMPATIBLE WITH
PHONE WIDTH



art. **DU20**

Barcode: 5901292792022
Packaging: 100 pcs.

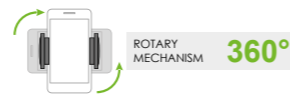

art. **DU26**

Barcode: 5901292792640
Packaging: 60 pcs.

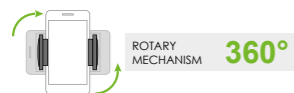

53-95 mm
COMPATIBLE WITH
PHONE WIDTH



art. **DU12**

Barcode: 5901292791278
Packaging: 32 pcs.



145-250 mm
COMPATIBLE WITH
PHONE WIDTH

art. **DU18**

Barcode: 5901292791896
Packaging: 60 pcs.



125-200 mm
COMPATIBLE WITH
PHONE WIDTH

HEADREST HOOK WITH PHONE HOLDER

art. **DU28**

Barcode: 5901292792886
Packaging: 100 pcs.



55-95 mm
COMPATIBLE WITH
PHONE WIDTH



4kg
MAX. LOAD
WEIGHT

INSTALLATION
ON THE HEADREST

PVA CLOTH ARTIFICIAL SUEDE

art. CA14

Dimensions: 43x32 cm
Packaging: 12/144 pcs.
Barcode: 5908669240148



art. CA28

Dimensions: 64x43 cm
Packaging: 12/96 pcs.
Barcode: 5908669240285



CAR CIGARETTE LIGHTER SOCKET SPLITTER

2 IN 1

art. RP11

Barcode: 5901292801168
Packaging: 10/20 pcs.

Input voltage	DC 12 V
Output voltage	DC 12 V
Max. output current	10A
Power cord length	1,3m
Working temperature	-40°C +80°C



3 IN 1 + USB

art. RP12

Barcode: 5901292801236
Packaging: 10/20 pcs.



4 IN 1 + USB

art. RP13

Barcode: 5901292801304
Packaging: 10/20 pcs.



Input voltage	DC 12V
Output voltage	1000mA
Max. output voltage:	
- for cigarette lighter/plug	DC 12V
- for USB	5V
Max. output current	10A
Power cord length	1,3m
Working temperature	-40°C +80°C

Input voltage	DC 12V
Output voltage	1000mA
Max. output voltage:	
- for cigarette lighter/plug	DC 12V
- for USB	5V
Max. output current	10A
Power cord length	1,3M
Working temperature	-40°C +80°C

BATTERY TERMINALS

art. BA12



Material: lead
Weight: 200 g
Packaging: 120 pcs.
Barcode: 5901292751296

art. BA13



Material: brass
Weight: 185 g
Packaging: 120 pcs.
Barcode: 5901292751364

art. BA14



Material: lead
Weight: 300 g
Packaging: 80 pcs.
Barcode: 5901292751432

art. BA15



Material: lead
Weight: 330 g
Packaging: 24 pcs.
Barcode: 5901222419548

art. BA16



Material: lead
Weight: 200 g
Packaging: 24 pcs.
Barcode: 5901222419616

art. BA17



Material: lead
Weight: 375 g
Packaging: 24 pcs.
Barcode: 5901222419784

art. BA18



Material: brass
Weight: 155 g
Packaging: 24 pcs.
Barcode: 5901222419852

art. BA19



Material: brass
Weight: 190 g
Packaging: 24 pcs.
Barcode: 5901222419920

art. BA20



Material: brass
Weight: 190 g
Packaging: 24 pcs.
Barcode: 5901222420056

HIGH RELIABILITY AUTOMOTIVE FUSES SET

art. AP51

10pcs.

Packaging: 200 pcs.
Barcode: 5901292795160



art. AP52

10pcs.

Packaging: 200 pcs.
Barcode: 5901292795238



art. AP53

10pcs.

Packaging: 200 pcs.
Barcode: 5901292795306



"cylindrical"



5-25A

"mini"



5-30A

"standard"

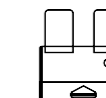

5-30A

MIX SET «STANDARD»



art. AP67 80pcs.

Packaging: 50 pcs.
Barcode: 5901292796778
7,5A - 10pcs. 20A - 10pcs.
10A - 20pcs. 25A - 10pcs.
15A - 20pcs. 30A - 10pcs.

+ fuse extractor

Always replace with fuse of the specified type and rating

MIX SET «MINI»



art. AP74 160pcs.

Packaging: 50 pcs.
Barcode: 5901292797454
7,5A - 20pcs. 20A - 20pcs.
10A - 40pcs. 25A - 20pcs.
15A - 40pcs. 30A - 20pcs.

+ fuse extractor

Always replace with fuse of the specified type and rating

AUTOMOTIVE FUSES SET "STANDARD"

art.AP61

50pcs.

Packaging: 100 pcs.
Barcode: 5901292796150



7.5A



art.AP62

50pcs.

Packaging: 100 pcs.
Barcode: 5901292796228



10A



art.AP68

100pcs.

Packaging: 100 pcs.
Barcode: 5901292796846



7.5A



art.AP69

100pcs.

Packaging: 100 pcs.
Barcode: 5901292796914



10A



art.AP63

50pcs.

Packaging: 100 pcs.
Barcode: 5901292796396



15A



art.AP64

50pcs.

Packaging: 100 pcs.
Barcode: 5901292796464



20A



art.AP70

100pcs.

Packaging: 100 pcs.
Barcode: 5901292797072



15A



art.AP71

100pcs.

Packaging: 100 pcs.
Barcode: 5901292797140



20A



art.AP65

50pcs.

Packaging: 100 pcs.
Barcode: 5901292795924



25A



art.AP66

50pcs.

Packaging: 100 pcs.
Barcode: 5901292796600



30A



art.AP72

100pcs.

Packaging: 100 pcs.
Barcode: 5901292797218



25A



art.AP73

100pcs.

Packaging: 100 pcs.
Barcode: 5901292797386



30A



AUTOMOTIVE FUSES SET "CYLINDRICAL"

art.AP59

100pcs.

Packaging: 100 pcs.
Barcode: 5901292795924

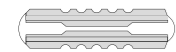

8A



art.AP60

100pcs.

Packaging: 100 pcs.
Barcode: 5901292796082



16A



BLACK CABLE TIES



-35°C – +85°C
COLOR: BLACK
 MATERIAL: **Neylon 6.6**
 SAFETY STANDARD: **UL 62275**



ISO 9001:2008

ART.	WIDTH, THICKNESS (mm)	PACKAGING	BARCODE
W25100	2,5 × 100	500 pcs.	5901290251064
W25150	2,5 × 150	350 pcs.	5901290251514
W25200	2,5 × 200	300 pcs.	5901290252054
W36150	3,6 × 150	250 pcs.	5901290361572
W36200	3,6 × 200	200 pcs.	5901290362012
W36250	3,6 × 250	100 pcs.	5901290362562
W36300	3,6 × 300	150 pcs.	5901290363002
W36370	3,6 × 370	120 pcs.	5901290363798
W48250	4,8 × 250	130 pcs.	5901290482598
W48300	4,8 × 300	100 pcs.	5901290483038
W48350	4,8 × 350	80 pcs.	5901290483588
W48380	4,8 × 380	75 pcs.	5901290483595
W48400	4,8 × 400	70 pcs.	5901290484028
W48450	4,8 × 450	60 pcs.	5901290485018
W76300	7,6 × 300	50 pcs.	5901290763062
W76350	7,6 × 350	45 pcs.	5901290763512
W76400	7,6 × 400	40 pcs.	5901290764052
W76450	7,6 × 450	35 pcs.	5901290764502
W76500	7,6 × 500	30 pcs.	5901290765042

ART.	WIDTH, THICKNESS (mm)	PACKAGING	BARCODE
B25100	2,5 × 100	500 pcs.	5901291251032
B25150	2,5 × 150	350 pcs.	5901291251582
B25200	2,5 × 200	300 pcs.	5901291252022
B36150	3,6 × 150	300 pcs.	5901291361540
B36200	3,6 × 200	200 pcs.	5901291362080
B36250	3,6 × 250	200 pcs.	5901290362531
B36300	3,6 × 300	150 pcs.	5901291363070
B36370	3,6 × 370	120 pcs.	5901291363766
B48250	4,8 × 250	130 pcs.	5901291482566
B48300	4,8 × 300	100 pcs.	5901291483006
B48350	4,8 × 350	80 pcs.	5901291483556
B48380	4,8 × 380	75 pcs.	5901291483860
B48400	4,8 × 400	70 pcs.	5901291484096
B48450	4,8 × 450	60 pcs.	5901291484546
B76300	7,6 × 300	50 pcs.	5901291763030
B76350	7,6 × 350	45 pcs.	5901291763580
B76400	7,6 × 400	40 pcs.	5901291764020
B76450	7,6 × 450	35 pcs.	5901291764570
B76500	7,6 × 500	30 pcs.	5901291765010

GRAY CABLE TIES

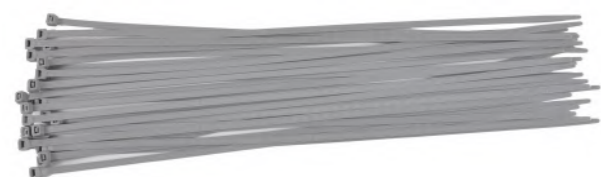

-35°C – +85°C
COLOR: GRAY
 MATERIAL: **Neylon 6.6**
 SAFETY STANDARD: **UL 62275**

ART.	WIDTH, THICKNESS (mm)	PACKAGING	BARCODE
G25200	2,5 × 200	300 pcs.	5901292252090
G36250	3,6 × 250	180 pcs.	5901292362508
G36370	3,6 × 370	100 pcs.	5901290363736
G48350	4,8 × 350	100 pcs.	5901292483524
G48380	4,8 × 380	80 pcs.	5901290483830
G48450	4,8 × 450	70 pcs.	5901292484514



ISO 9001:2008

WHITE CABLE TIES



-35°C – +85°C
COLOR: WHITE
 MATERIAL: **Neylon 6.6**
 SAFETY STANDARD: **UL 62275**



ISO 9001:2008



The tape is fire-resistant, ignites only under the influence of an open flame, immediately extinguishes when removed from the fire.



Resistance to high voltage prevents short circuits and ensures safe work of the master with electrical wiring.



The good flexibility and elasticity of the insulating tape makes it possible to conveniently work with wires of small diameter.



art. BI61
10m
0,13 mm x 19 mm
 Color: blue
 Packaging: 300 pcs.
 Barcode: 5901292766146



art. BI71
10m
0,13 mm x 19 mm
 Color: black
 Packaging: 300 pcs.
 Barcode: 5901292767136



art. BI62
20m
0,13 mm x 19 mm
 Color: blue
 Packaging: 200 pcs.
 Barcode: 5901292766214



art. BI72
20m
0,13 mm x 19 mm
 Color: black
 Packaging: 200 pcs.
 Barcode: 5901292767204



art. BI63
25m
0,13 mm x 19 mm
 Color: blue
 Packaging: 200 pcs.
 Barcode: 5901292766382



art. BI73
25m
0,13 mm x 19 mm
 Color: black
 Packaging: 200 pcs.
 Barcode: 5901292767372



art. BI64
30m
0,13 mm x 19 mm
 Color: blue
 Packaging: 200 pcs.
 Barcode: 5901292766450



art. BI74
30m
0,13 mm x 19 mm
 Color: black
 Packaging: 200 pcs.
 Barcode: 5901292767440

BELAUTO®



PROFESSIONAL ELECTRIC WINCHES



ZUBR

GRIZZLY

VEPR

BELAUTO®



PROFESSIONAL ELECTRIC WINCHES

ZUBR Professional electric winch Z12500S



ZUBR Professional electric winch Z12500



Z12500S

Z12500

Rated line pull	12500lbs (5670KG)	12500lbs (5670KG)
Motor	12V DC 6.0hp/4.4kw	12V DC 60hp/4.4kw
Solenoid	500 Amp	500 Amp
Gear ratio	262:1	262:1
Gear train	3 stage planetary	3 stage planetary
Brakes	automatic	automatic
Drum size	diameter-64mm; length-224mm	diameter-64mm; length-224mm
Wire rope	synthetic: diameter-11mm; length-24m	steel: diameter-9,5mm; length-25m
Guideline ropes	aluminum hawse fairlead	rollers
Mounting holes	254mm×114,3mm	254mm×114,3mm
Size	577mm×170mm×197mm	577mm×170mm×197mm
Weight	32 kg	43 kg
Remote control	Wired remote control (3,2m) + remote control	Wired remote control (3,2m) + remote control
Protection class	IP68	IP68
Recommended battery	CCA 650A	CCA 650A



ZUBR

Professional electric winch

Z15000

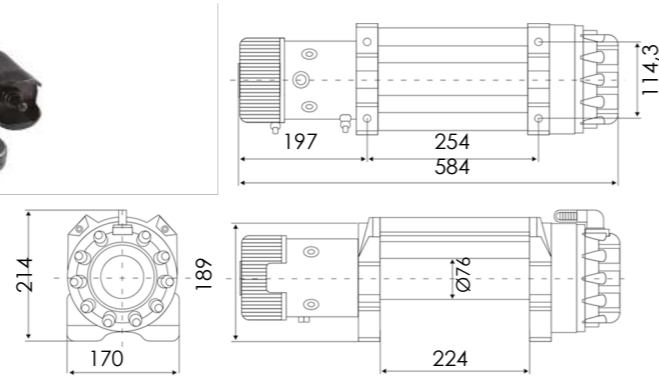

ZUBR

Professional electric winch

Z9500

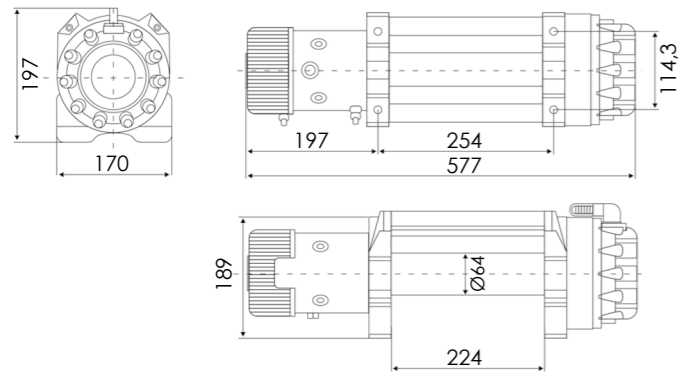

Z9500

Z15000

Rated line pull	9500lbs (4310KG)	15000lbs (6804KG)
Motor	12V DC 6.0hp/4.4kw	12V DC 6.8hp/5.0kw
Solenoid	500 Amp	500 Amp
Gear ratio	212:1	262:1
Gear train	3 stage planetary	3 stage planetary
Brakes	automatic	automatic
Drum size	diameter-64mm; length-224mm	diameter-76mm; length-224mm
Wire rope	steel: diameter-7,8mm; length-28m	steel: diameter-11mm; length-24m
Guideline ropes	rollers	rollers
Mounting holes	254mm×114,3mm	254mm×114,3mm
Size	577mm×170mm×197mm	584mm×170mm×214mm
Weight	40 kg	50 kg
Remote control	Wired remote control (3,2m) + remote control	Wired remote control (3,2m) + remote control
Protection class	IP68	IP68
Recommended battery	CCA 650A	CCA 650A



VEPR

Professional electric winch

V12000

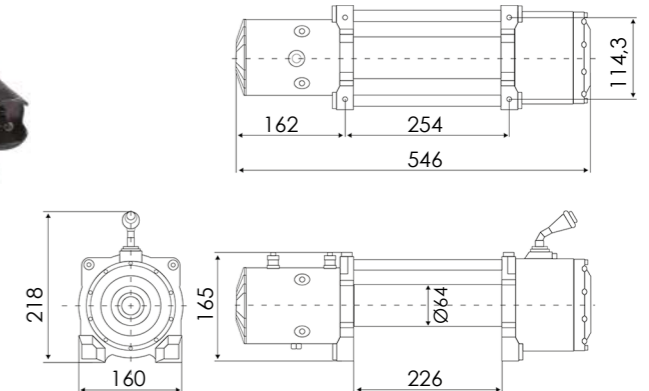

VEPR

Professional electric winch

V9500

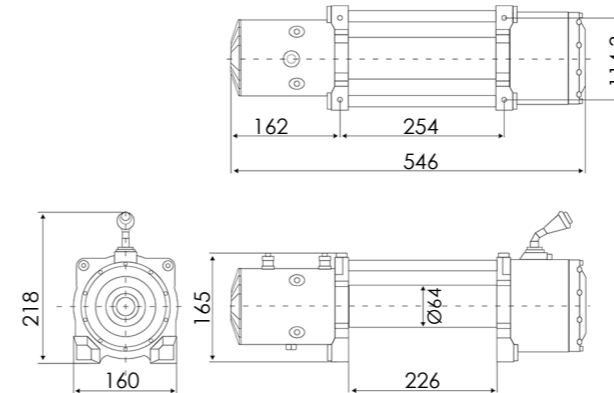

V9500

V12000

Rated line pull	9500lbs (4310KG)	12000lbs (5443KG)
Motor	12V DC 5.5hp/4.1kw	12V DC 6.0hp/4.4kw
Solenoid	2 x 250 Amp	2 x 250 Amp
Gear ratio	218:1	265:1
Gear train	3 stage planetary	3 stage planetary
Brakes	automatic	automatic
Drum size	diameter-64mm; length-226mm	diameter-64mm; length-226mm
Wire rope	steel: diameter-7,8mm; length-28m	steel: diameter-9,5mm; length-25m
Guideline ropes	rollers	rollers
Mounting holes	254mm×114,3mm	254mm×114,3mm
Size	546mm×160mm×218mm	546mm×160mm×218mm
Weight	36 kg	40 kg
Remote control	Wired remote control (3,2m) + remote control	Wired remote control (3,2m) + remote control
Protection class	IP65	IP65
Recommended battery	CCA 650A	CCA 650A

SYNTHETIC ROPE FOR WINCH

with «standard» hook

ART: SWR 2610

Diameter: 11 mm
Length: 26 m
Material: synthetic



SYNTHETIC ROPE FOR WINCH

with reinforced hook

ART: SWR 2620

Diameter: 11 mm
Length: 26 m
Material: synthetic



GUIDE FOR SYNTHETIC CABLE

ART: WHF 3008

Material: aluminum



TOWING SHACKLE

rigging for winch rope

Lifting capacity: 4,75 T
Material: steel



Tree trunk protector strap

TM BELAUTO OFF ROAD DOES NOT RECOMMEND USING ROPE FOR WINCH to reach a tree (or pole) when pulling out an SUV. This can seriously damage the rope for winch. For this procedure, it is recommended to additionally use a special coverage made of polyester - a tree protector.

ART: BOT 0803

Lifting capacity: 8 T
Width: 80 mm
Length: 3 m
Elasticity: 7 %
Material: polyester
Reinforced ear structure: +

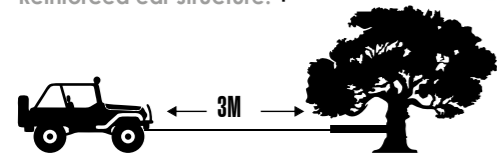

ART: BOT 0805

Lifting capacity: 8 T
Width: 80 mm
Length: 5 m
Elasticity: 7 %
Material: polyester
Reinforced ear structure: +

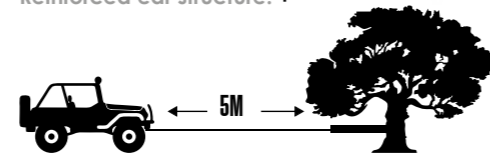

ART: BOT 1203

Lifting capacity: 12 T
Width: 80 mm
Length: 3 m
Elasticity: 7 %
Material: polyester
Reinforced ear structure: +

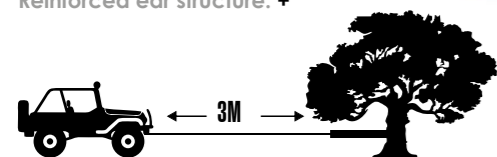

ART: BOT 1205

Lifting capacity: 12 T
Width: 80 mm
Length: 5 m
Elasticity: 7 %
Material: polyester
Reinforced ear structure: +

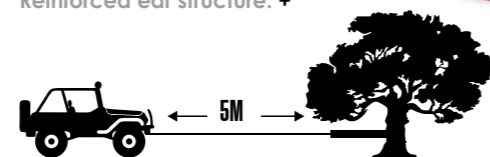

Extension rope for winch

Specially designed extension rope for winches manufactured by **BELAUTO OFF ROAD**. Effective when pulling out a stuck SUV or other vehicle. Are perfect for lengthening the winch cable in a situation where the nearest attachment point is out of reach of the cable.

Tow cable extension winch with a permissible load of 6t and 8t is recommended for most four-wheel drive vehicles, 11 ton is recommended for heavier models.

All winch extension tow ropes are made to high quality standards of **TM BELAUTO** and tested for strength.

ART: BOT 0609

Lifting capacity: 6 T
Width: 50 mm
Length: 9 m
Elasticity: 7 %
Material: polyester
Reinforced ear structure: +

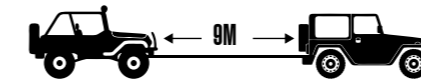

ART: BOT 0620

Lifting capacity: 6 T
Width: 50 mm
Length: 20 m
Elasticity: 7 %
Material: polyester
Reinforced ear structure: +



ART: BOT 0809

Lifting capacity: 8 T
Width: 80 mm
Length: 9 m
Elasticity: 7 %
Material: polyester
Reinforced ear structure: +

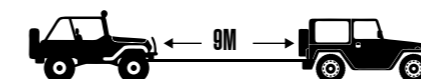

ART: BOT 0820

Lifting capacity: 8 T
Width: 80 mm
Length: 20 m
Elasticity: 7 %
Material: polyester
Reinforced ear structure: +

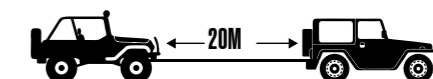

ART: BOT 1109

Lifting capacity: 11 T
Width: 80 mm
Length: 9 m
Elasticity: 7 %
Material: polyester
Reinforced ear structure: +

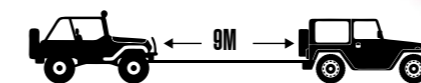

ART: BOT 1120

Lifting capacity: 11 T
Width: 80 mm
Length: 20 m
Elasticity: 7 %
Material: polyester
Reinforced ear structure: +

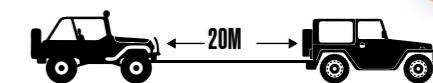

BELAUTO[®]

OFF ROAD

LED LIGHTING



BELAUTO

OFF ROAD

LED LIGHTING

ART: BOL 0160

Barcode: 5901292409364

HIGH + LOW BEAM

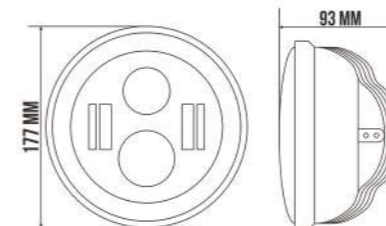

4ETI **60w** **4320/2160 LUMEN** **IP69K**

The headlight is suitable for all cars and motorcycles with headlights with a diameter of 7 inches (177mm): UAZ, Niva, VAZ 2101, 02, Jeep Wrangler, Nissan Patrol, Land Rover Defender, Hummer, Mercedes G-class, Harley Davidson, etc.

Model Number	BOL 0160
Power Output	60 W
Operating Voltage	DC9 - 60V
LED Chip	5W ETI*4pcs
Lumens	4320Lm/2160Lm
Color Temperature	6000K
Waterproof Rate	IP69K
Housing Material	diecast aluminum
Lens Material	PC
Dimensions	177*93 mm
Operating Temperature	-45°C/+60°C
Life Span	Above 30,000 hours
Warranty	12 months

LAMP MODES



DAYTIME RUNNING LIGHTS



TURN REPEATER



PASSING LIGHT



HIGH BEAM

ART: BOL 0175

Barcode: 5901292409432

COMBO

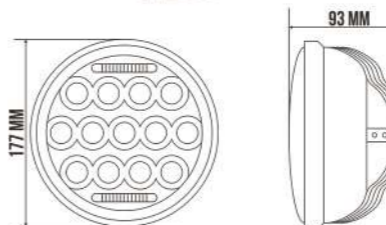

13LED CREE 2DRL **75w** **5200/2000 LUMEN** **IP69K**

The headlight is suitable for all cars and motorcycles with headlights with a diameter of 7 inches (177mm): UAZ, Niva, VAZ 2101, 02, Jeep Wrangler, Nissan Patrol, Land Rover Defender, Hummer, Mercedes G-class, Harley Davidson i etc.

Model Number	BOL 0175
Power Output	75 W
Operating Voltage	DC9 - 60V
LED Chip	5W CREE*13pcs 5W DRL*2pcs
Lumens	5200Lm/2000Lm
Color Temperature	6000K
Waterproof Rate	IP69K
Housing Material	diecast aluminum
Lens Material	PC
Dimensions	177*93 mm
Operating Temperature	-45°C/+60°C
Life Span	Above 50,000 hours
Warranty	12 months

LAMP MODES



DAYTIME RUNNING LIGHTS

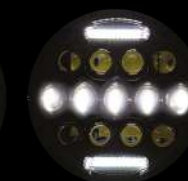

PASSING LIGHT



HIGH BEAM

ART: BOL 0110LS

Barcode: 5901290011002



ART: BOL 0110LF

Barcode: 5901291011070



Model Number BOL 0110L
 Power Output 10 W
 Operating Voltage DC10 - 30V
 LED Chip 10W CREE*1pcs
 Lumens 1000Lm
 Color Temperature 6000K
 Waterproof Rate IP69K
 Housing Material diecast aluminum
 Lens Material PC
 Housing Color black
 Dimensions 57*57*65 mm
 Operating Temperature -45°C/+60°C
 Life Span Above 30,000 hours
 Warranty 12 months

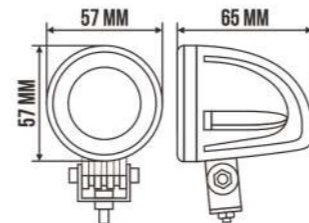

1 LED CREE

10w

1000 LUMEN

IP69K

ART: BOL 0103S

Barcode: 5901292404864

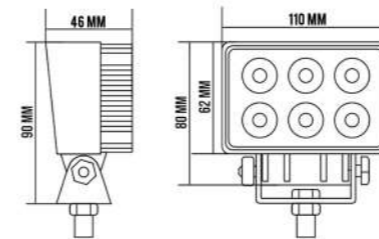

6 LED EPISTAR

18w

1320 LUMEN

IP69K

ART: BOL 0103F

Barcode: 5901292404932



Model Number BOL 0103
 Power Output 18 W
 Operating Voltage DC10 - 30V
 LED Chip 3W EPISTAR*6pcs
 Lumens 1320Lm
 Color Temperature 6000K
 Waterproof Rate IP69K
 Housing Material diecast aluminum
 Lens Material PC
 Dimensions 62*110*46 mm
 Operating Temperature -45°C/+60°C
 Life Span Above 30,000 hours
 Warranty 12 months

4D LENS

ART: BOL 0210L

Barcode: 5901292404796



Model Number BOL 0210L
 Power Output 20 W
 Operating Voltage DC10 - 30V
 LED Chip 10W CREE*2pcs
 Lumens 1400Lm
 Color Temperature 6000K
 Waterproof Rate IP69K
 Housing Material diecast aluminum
 Lens Material 4D PC
 Housing Color black
 Dimensions 97*62*75 mm
 Operating Temperature -45°C/+60°C
 Life Span Above 30,000 hours
 Warranty 12 months

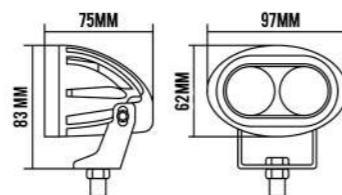

20w

1400 LUMEN

Model Number BOL 0503
 Power Output 15 W
 Operating Voltage DC10 - 30V
 LED Chip 3W EPISTAR*5pcs
 Lumens 1000Lm
 Color Temperature 6000K
 Waterproof Rate IP69K
 Housing Material diecast aluminum
 Lens Material PC
 Housing Color black
 Dimensions 108*108*47 mm
 Operating Temperature -45°C/+60°C
 Life Span Above 30,000 hours
 Warranty 12 months



ART: BOL 0503S

Barcode: 5901292402716



ART: BOL 0503F

Barcode: 5901292402952



5 LED EPISTAR

15w

1000 LUMEN

IP69K

ART: BOL 0403S
Barcode: 5901292405090

ART: BOL 0403F
Barcode: 5901292405168

Model Number BOL 0403
Power Output 12 W
Operating Voltage DC10 - 30V
LED Chip 3W EPISTAR*4pcs
Lumens 880Lm
Color Temperature 6000K
Waterproof Rate IP69K
Housing Material diecast aluminum
Lens Material PC
Dimensions 83*109*76 mm
Operating Temperature -45°C/+60°C
Life Span Above 30,000 hours
Warranty 12 months

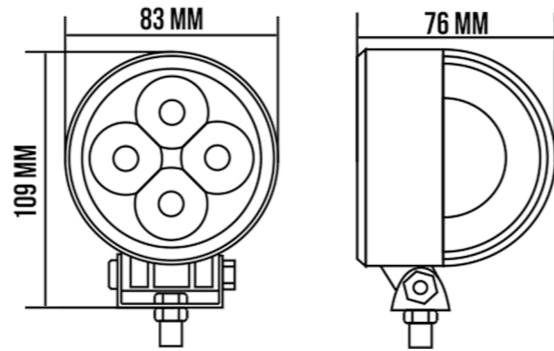

4LED EPISTAR **12W** **880 LUMEN** **IP69K**

Model Number BOL 0603
Power Output 18 W
Operating Voltage DC10 - 30V
LED Chip 3W EPISTAR*6pcs
Lumens 1320Lm
Color Temperature 6000K
Waterproof Rate IP69K
Housing Material diecast aluminum
Lens Material PC
Dimensions 112*112*45 mm
Operating Temperature -45°C/+60°C
Life Span Above 30,000 hours
Warranty 12 months

ART: BOL 0603S
Barcode: 5901292405472

ART: BOL 0603F
Barcode: 5901292405540

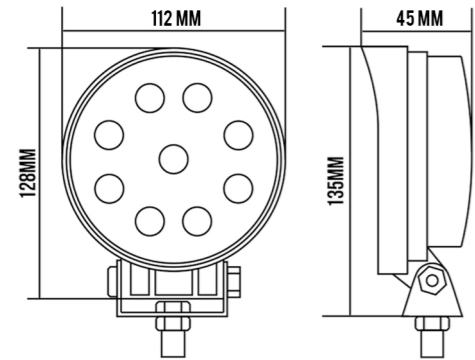

6LED EPISTAR **18W** **1320 LUMEN** **IP69K**

ART: BOL 0903S
Barcode: 5901292405618

ART: BOL 0903F
Barcode: 5901292405786

Model Number BOL 0903
Power Output 27 W
Operating Voltage DC10 - 30V
LED Chip 3W EPISTAR*9pcs
Lumens 1980Lm
Color Temperature 6000K
Waterproof Rate IP69K
Housing Material diecast aluminum
Lens Material PC
Dimensions 112*112*45 mm
Operating Temperature -45°C/+60°C
Life Span Above 30,000 hours
Warranty 12 months

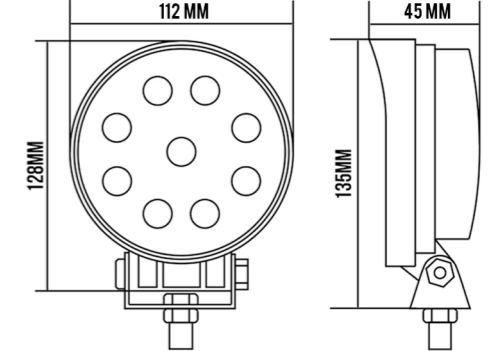

9LED EPISTAR **27W** **1980 LUMEN** **IP69K**

Model Number BOL 0903Q
Power Output 27 W
Operating Voltage DC10 - 30V
LED Chip 3W EPISTAR*9pcs
Lumens 1980Lm
Color Temperature 6000K
Waterproof Rate IP69K
Housing Material diecast aluminum
Lens Material PC
Dimensions 112*112*45 mm
Operating Temperature -45°C/+60°C
Life Span Above 30,000 hours
Warranty 12 months

ART: BOL 0903QS
Barcode: 5901290090380

ART: BOL 0903QF
Barcode: 5901291090358

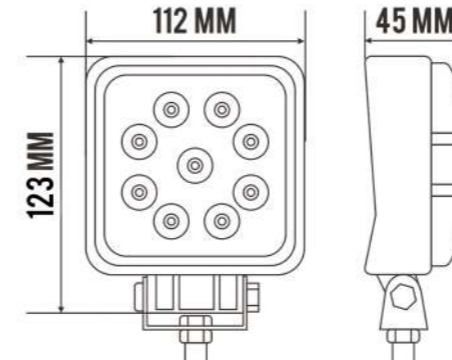

9LED EPISTAR **27W** **1980 LUMEN** **IP69K**

ART: BOL 1403S

Barcode: 5901290140320



14LED
EPISTAR

42W

2800
LUMEN

IP69K

ART: BOL 1403F

Barcode: 5901291140398



Model Number BOL 1403
Power Output 42 W
Operating Voltage DC10 - 30V
LED Chip 3W EPISTAR*14pcs
Lumens 2800Lm
Color Temperature 6000K
Waterproof Rate IP69K
Housing Material diecast aluminum
Lens Material PC
Housing Color black
Dimensions 112*112*50 mm
Operating Temperature -45°C/+60°C
Life Span Above 30,000 hours
Warranty 12 months

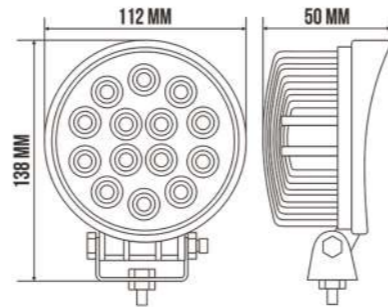

Model Number BOL 1803
Power Output 48 W
Operating Voltage DC10 - 30V
LED Chip 3W EPISTAR*16pcs
Lumens 3520Lm
Color Temperature 6000K
Waterproof Rate IP69K
Housing Material diecast aluminum
Lens Material PC
Housing Color black
Dimensions 108*108*58 mm
Operating Temperature -45°C/+60°C
Life Span Above 30,000 hours
Warranty 12 months

ART: BOL 1803S

Barcode: 5901290180302



16LED
EPISTAR

48W

3520
LUMEN

IP69K

ART: BOL 1803F

Barcode: 5901291180370

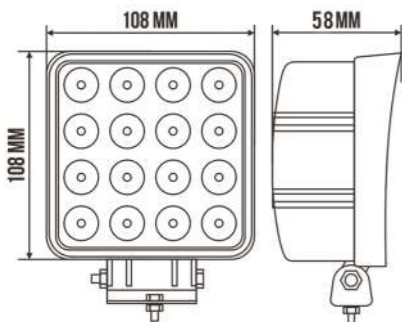

ART: BOL 0203S

Barcode: 5901292405236



ART: BOL 0203F

Barcode: 5901292405304



Model Number BOL 0203
Power Output 18 W
Operating Voltage DC10 - 30V
LED Chip 3W EPISTAR*6pcs
Lumens 1320Lm
Color Temperature 6000K
Waterproof Rate IP69K
Housing Material diecast aluminum
Lens Material PC
Dimensions 158*44*50 mm
Operating Temperature -45°C/+60°C
Life Span Above 30,000 hours
Warranty 12 months

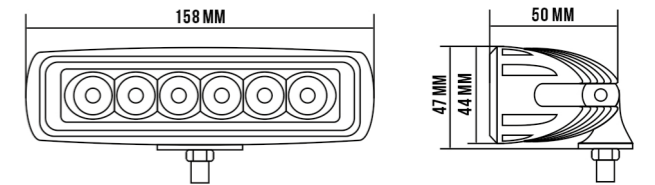

6LED
EPISTAR

18W

1320
LUMEN

IP69K

Model Number BOL 0603
Power Output 24 W
Operating Voltage DC9 - 30V
LED Chip 3W CREE*6pcs
Lumens 2400Lm
Color Temperature 6000K
Waterproof Rate IP69K
Housing Material diecast aluminum
Lens Material PC
Dimensions 80*75*82 mm
Operating Temperature -45°C/+60°C
Life Span Above 30,000 hours
Warranty 12 months

ART: BOL 0604S

Barcode: 5901292406080



ART: BOL 0604F

Barcode: 5901292406158

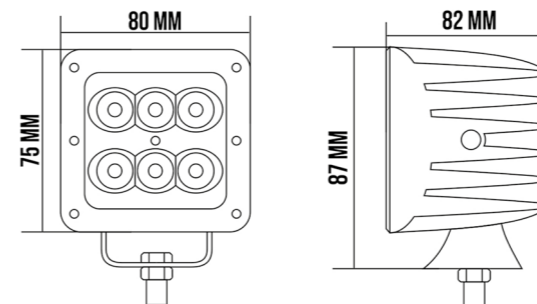

6LED
CREE

24W

2400
LUMEN

IP69K

ART: BOL 1703S

Barcode: 5901290170334

SPOT



17LED
EPISTAR

51W

3400
LUMEN

IP69K

ART: BOL 1703F

Barcode: 5901291170302

FLOOD

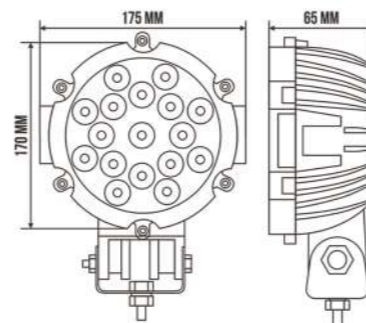

Model Number BOL 1703
 Power Output 51 W
 Operating Voltage DC10 - 30V
 LED Chip 3W EPISTAR*17pcs
 Lumens 3400Lm
 Color Temperature 6000K
 Waterproof Rate IP69K
 Housing Material diecast aluminum
 Lens Material PC
 Housing Color black
 Dimensions 175*170*65 mm
 Operating Temperature -45°C/+60°C
 Life Span Above 30,000 hours
 Warranty 12 months

Model Number BOL 2103
 Power Output 63 W
 Operating Voltage DC10 - 30V
 LED Chip 3W EPISTAR*21pcs
 Lumens 4200Lm
 Color Temperature 6000K
 Waterproof Rate IP69K
 Housing Material diecast aluminum
 Lens Material PC
 Housing Color black
 Dimensions 175*170*65 mm
 Operating Temperature -45°C/+60°C
 Life Span Above 30,000 hours
 Warranty 12 months

ART: BOL 2103S

Barcode: 5901290210306

SPOT



21LED
EPISTAR

63W

4200
LUMEN

IP69K

ART: BOL 2103F

Barcode: 5901291210374

FLOOD

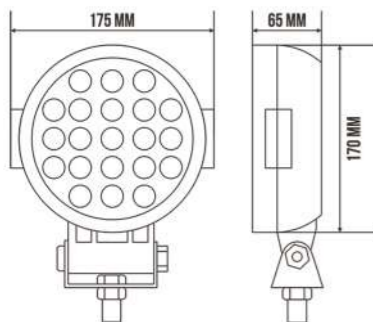

Model Number BOL 0410

Power Output 40 W
 Operating Voltage DC9 - 60V
 LED Chip 10W CREE*4pcs
 Lumens 3200Lm
 Color Temperature 6000K
 Waterproof Rate IP69K
 Housing Material diecast aluminum
 Lens Material PC
 Dimensions 125*155*88 mm
 Operating Temperature -45°C/+60°C
 Life Span Above 30,000 hours
 Warranty 12 months

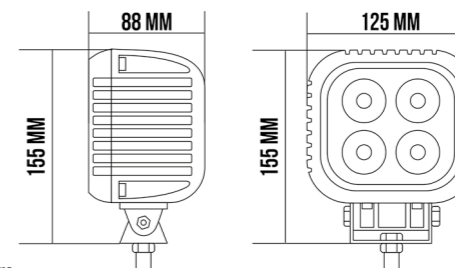

4LED
CREE

40W

3200
LUMEN

IP69K



ART: BOL 0410F

Barcode: 5901292406226

FLOOD



ART: BOL 1603F

Barcode: 5901292406394

FLOOD



Model Number BOL 1603
 Power Output 48 W
 Operating Voltage DC9 - 60V
 LED Chip 3W CREE*16pcs
 Lumens 4480Lm
 Color Temperature 6000K
 Waterproof Rate IP69K
 Housing Material diecast aluminum
 Lens Material PC
 Dimensions 125*155*88 mm
 Operating Temperature -45°C/+60°C
 Life Span Above 30,000 hours
 Warranty 12 months

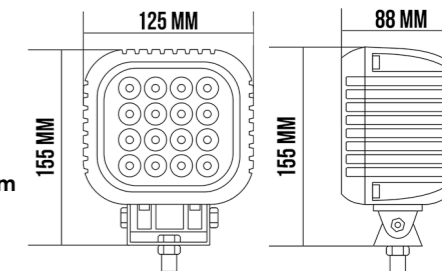

16LED
CREE

48W

4480
LUMEN

IP69K



Model Number BOL 0710
 Power Output 70 W
 Operating Voltage DC9 - 60V
 LED Chip 10W CREE*7pcs
 Lumens 5600Lm
 Color Temperature 6000K
 Waterproof Rate IP69K
 Housing Material diecast aluminum
 Lens Material PC
 Dimensions 150*175*105 mm
 Operating Temperature -45°C/+60°C
 Life Span Above 30,000 hours
 Warranty 12 months

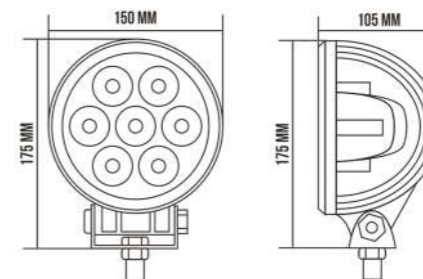

7LED
CREE

70W

5600
LUMEN

IP69K



ART: BOL 0710F

Barcode: 5901292406530

FLOOD



BOL 1503 SERIES CONSTRUCTION

1. Durable 6063 aluminum alloy body with black matte finish.
2. High-quality board with a metal base for better heat dissipation.
3. Rubber seals to provide protection against water and dirt according to the IP69K standard.
4. Highly efficient EPIOSTAR LED chips.
5. A high-quality reflector effectively directs the light beam.
6. Strong polycarbonate glass with a reflector.
7. Anti-corrosion bolts made of stainless steel.
8. Strong and reliable fastening with stainless steel bolts.

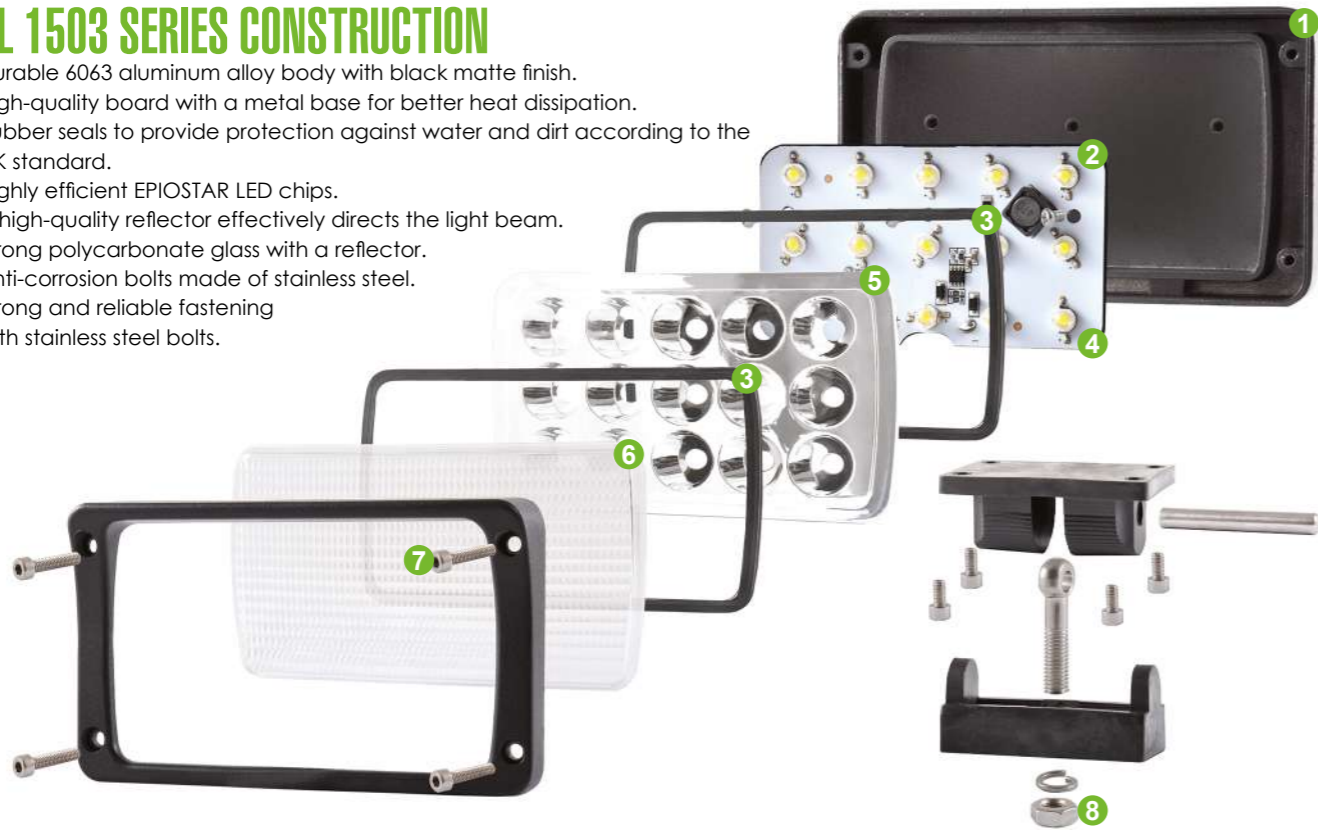

ART: BOL 1503S
Barcode: 5901292405854



ART: BOL 1503F
Barcode: 5901292405922



Model Number BOL 1503
Power Output 45 W
Operating Voltage DC10 - 30V
LED Chip 3W EPISTAR*15pcs
Lumens 3300Lm
Color Temperature 6000K
Waterproof Rate IP69K
Housing Material diecast aluminum
Lens Material PC
Dimensions 160*94*76 mm
Operating Temperature -45°C/+60°C
Life Span Above 30,000 hours
Warranty 12 months

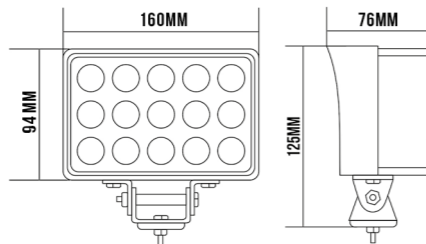

15LED EPISTAR
3300 LUMEN
45w
IP69K

ART: BOL 0310L
Barcode: 5901290031048



Model Number BOL 0310L
Power Output 30 W
Operating Voltage DC10 - 30V
LED Chip 10W CSP1860DE*3pcs
Lumens 2700Lm
Color Temperature 6000K
Waterproof Rate IP69K
Housing Material diecast aluminum
Lens Material PC
Dimensions 116*116*60 mm
Operating Temperature -45°C/+60°C
Life Span Above 30,000 hours
Warranty 12 months

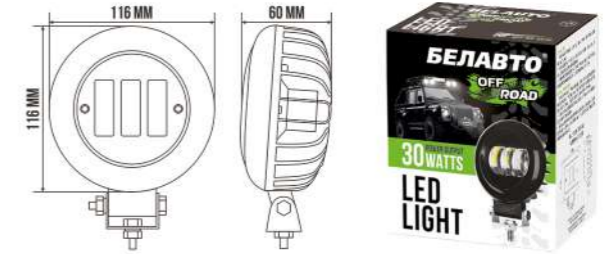

3CSP 1860DE
30w
2700 LUMEN
IP69K

Model Number BOL 0310QL
Power Output 30 W
Operating Voltage DC10 - 30V
LED Chip 10W CSP1860DE*3pcs
Lumens 2700Lm
Color Temperature 6000K
Waterproof Rate IP69K
Housing Material diecast aluminum
Lens Material PC
Dimensions 120*93*63 mm
Operating Temperature -45°C/+60°C
Life Span Above 30,000 hours
Warranty 12 months

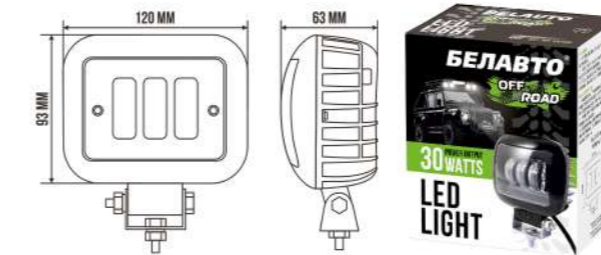

3CSP 1860DE
30w
2700 LUMEN
IP69K

ART: BOL 0310QL
Barcode: 5901280031058



ART: BOL 0403QL
Barcode: 5901292403638



4D LENS
4LED EPISTAR
800 LUMEN
12w

ART: BOL 0403QLA
Barcode: 5901292403706



ventilation hole

Model Number BOL 0403Q
Power Output 12 W
Operating Voltage DC10 - 30V
LED Chip 3W EPISTAR*4pcs
Lumens 800Lm
Color Temperature 6000K
Waterproof Rate IP69K
Housing Material diecast aluminum
Lens Material 4D PC
Housing Color black
Dimensions 75*75*49 mm
Operating Temperature -45°C/+60°C
Life Span Above 30,000 hours
Warranty 12 months

ART: BOL 0403L
Barcode: 5901292403874



4D LENS
4LED EPISTAR
800 LUMEN
12w

ART: BOL 0403LA
Barcode: 5901292403942



ventilation hole

Model Number BOL 0403L
Power Output 12 W
Operating Voltage DC10 - 30V
LED Chip 3W EPISTAR*4pcs
Lumens 800Lm
Color Temperature 6000K
Waterproof Rate IP69K
Housing Material diecast aluminum
Lens Material 4D PC
Housing Color black
Dimensions 82*82*52 mm
Operating Temperature -45°C/+60°C
Life Span Above 30,000 hours
Warranty 12 months

ART: BOL 0603L
Barcode: 5901292404000



4D LENS
6LED EPISTAR
1200 LUMEN
18w

ART: BOL 0603LA
Barcode: 5901292404178



ventilation hole

Model Number BOL 0603L
Power Output 18 W
Operating Voltage DC10 - 330V
LED Chip 3W EPISTAR*6pcs
Lumens 1200Lm
Color Temperature 6000K
Waterproof Rate IP69K
Housing Material diecast aluminum
Lens Material 4D PC
Housing Color black
Dimensions 78*112*52 mm
Operating Temperature -45°C/+60°C
Life Span Above 30,000 hours
Warranty 12 months

ART: BOL 0803L
Barcode: 5901292404246



4D LENS
8LED EPISTAR
1600 LUMEN
24w

ART: BOL 0803LA
Barcode: 5901292404314



ventilation hole

Model Number BOL 0803L
Power Output 24 W
Operating Voltage DC10 - 30V
LED Chip 3W EPISTAR*8pcs
Lumens 1600Lm
Color Temperature 6000K
Waterproof Rate IP69K
Housing Material diecast aluminum
Lens Material 4D PC
Housing Color black
Dimensions 90*150*65 mm
Operating Temperature -45°C/+60°C
Life Span Above 30,000 hours
Warranty 12 months

ART: BOL 0903L

Barcode: 5901292404482



ventilation hole



Model Number BOL 0903L
 Power Output 27 W
 Operating Voltage DC10 - 30V
 LED Chip 3W EPISTAR*9pcs
 Lumens 1800Lm
 Color Temperature 6000K
 Waterproof Rate IP69K
 Housing Material diecast aluminum
 Lens Material 4D PC
 Housing Color black
 Dimensions 104*104*56 mm
 Operating Temperature -45°C/+60°C
 Life Span Above 30,000 hours
 Warranty 12 months

4D LENS **9LED EPISTAR**
1800 LUMEN **27w**

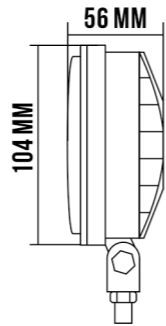
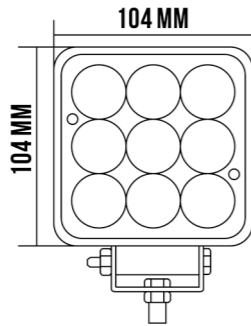

ART: BOL 0703S

Barcode: 5901290070344



6LED CREE **1200 LUMEN**
18w **IP69K**

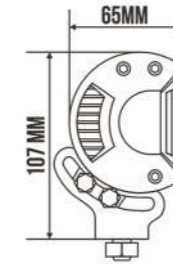
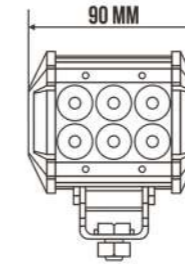

ART: BOL 0703F

Barcode: 5901291070312



Model Number BOL 0703
 Power Output 18 W
 Operating Voltage DC10 - 30V
 LED Chip 3W CREE*6pcs
 Lumens 1200Lm
 Color Temperature 6000K
 Waterproof Rate IP69K
 Housing Material diecast aluminum
 Lens Material 4D PC
 Housing Color black
 Dimensions 90*80*65 mm
 Operating Temperature -45°C/+60°C
 Life Span Above 30,000 hours
 Warranty 12 months

Model Number BOL 1503L
 Power Output 45 W
 Operating Voltage D109 - 30V
 LED Chip 3W EPISTAR*15pcs
 Lumens 3000Lm
 Color Temperature 6000K
 Waterproof Rate IP69K
 Housing Material diecast aluminum
 Lens Material 4D PC
 Housing Color black
 Dimensions 160*100*73 mm
 Operating Temperature -45°C/+60°C
 Life Span Above 30,000 hours
 Warranty 12 months



ventilation hole



High/Low switching function

ART: BOL 1503L

Barcode: 5901292404628



4D LENS **15LED EPISTAR**
3000 LUMEN **45w**

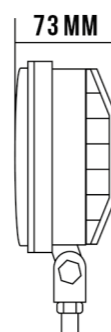
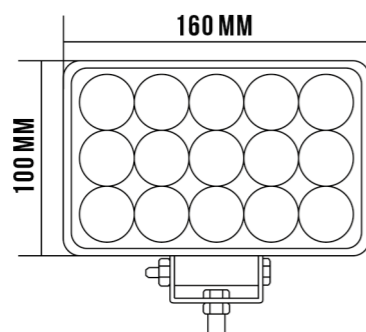

ART: BOL 1203S

Barcode: 5901292406608



Model Number BOL 1203
 Power Output 36 W
 Operating Voltage DC10 - 30V
 LED Chip 3W CREE*12pcs
 Lumens 3000Lm
 Color Temperature 6000K
 Waterproof Rate IP69K
 Housing Material diecast aluminum
 Lens Material PC
 Dimensions 167*80*65 mm
 Operating Temperature -45°C/+60°C
 Life Span Above 30,000 hours
 Warranty 12 months

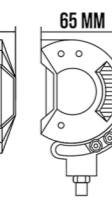
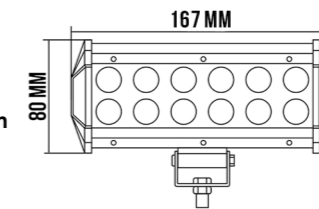

ART: BOL 1203F

Barcode: 5901292406776



12LED CREE **3000 LUMEN**
36w **IP69K**

BOL 2403 SERIES CONSTRUCTION

1. Durable 6063 aluminum alloy body with black matte finish.
2. High-quality board with a metal base for better heat dissipation.
3. Rubber seals to provide protection against water and dirt according to the IP69K standard.
4. Highly efficient EPISTAR LED chips.
5. A high-quality reflector effectively directs the light beam.
6. Transparent strong polycarbonate glass.
7. An efficient metal radiator allows the lamp to work for a long time at an optimal temperature.
8. Anti-corrosion bolts made of stainless steel.
9. Strong and reliable fastening with stainless steel bolts



ART: BOL 2403S

Barcode: 5901292406844



Model Number	BOL 2403
Power Output	72 W
Operating Voltage	DC10 - 90V
LED Chip	3W CREE*24pcs
Lumens	6000lm
Color Temperature	6000K
Waterproof Rate	IP69K
Housing Material	diecast aluminum
Lens Material	PC
Dimensions	300*80*65 mm
Operating Temperature	-45°C/+60°C
Life Span	Above 50,000 hours
Warranty	12 months

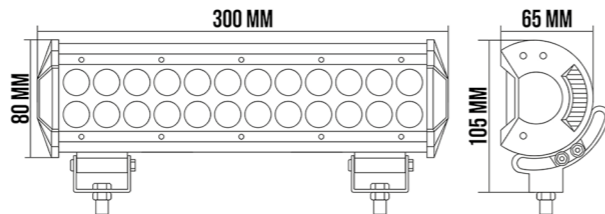

ART: BOL 2403F

Barcode: 5901292406912



ART: BOL 2403C

Barcode: 5901292407070



6000 LUMEN **24LED CREE** **72w** **IP69K**

ART: BOL 4003S

Barcode: 5901292407148



ART: BOL 4003F

Barcode: 5901292407216



ART: BOL 4003C

Barcode: 5901292407384



Model Number	BOL 4003
Power Output	120 W
Operating Voltage	DC9 - 60V
LED Chip	3W CREE*40pcs
Lumens	11200lm
Color Temperature	6000K
Waterproof Rate	IP69K
Housing Material	diecast aluminum
Lens Material	PC
Dimensions	540*82*87 mm
Operating Temperature	-45°C/+60°C
Life Span	Above 50,000 hours
Warranty	12 months

40LED CREE **11200 LUMEN**
120w **IP69K**

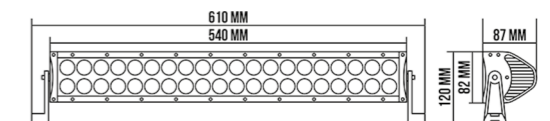

ART: BOL 6003S

Barcode: 5901292407452



Model Number	BOL 6003
Power Output	180 W
Operating Voltage	DC9 - 60V
LED Chip	3W CREE*60pcs
Lumens	16800lm
Color Temperature	6000K
Waterproof Rate	IP69K
Housing Material	diecast aluminum
Lens Material	PC
Dimensions	795*82*87 mm
Operating Temperature	-45°C/+60°C
Life Span	Above 50,000 hours
Warranty	12 months

60LED CREE **16800 LUMEN**
180w **IP69K**

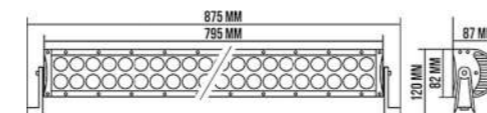

ART: BOL 6003F

Barcode: 5901292407520



ART: BOL 6003C

Barcode: 5901292407698



ART: BOL 8003S

Barcode: 5901292407766



ART: BOL 8003F

Barcode: 5901292407834



ART: BOL 8003C

Barcode: 5901292407902

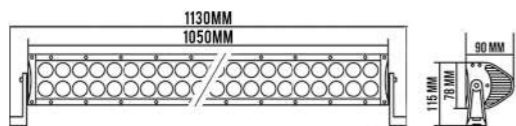

Model Number BOL 8003
 Power Output 240 W
 Operating Voltage DC9 - 60V
 LED Chip 3W CREE*80pcs
 Lumens 22400Lm
 Color Temperature 6000K
 Waterproof Rate IP69K
 Housing Material diecast aluminum
 Lens Material PC
 Dimensions 1050*78*90 mm
 Operating Temperature -45°C/+60°C
 Life Span Above 50,000 hours
 Warranty 12 months

80LED CREE **22400 LUMEN**
240w **IP69K**

Model Number BOL 8003C
 Power Output 240 W
 Operating Voltage DC9 - 60V
 LED Chip 3W CREE*80pcs
 Lumens 20000Lm
 Color Temperature 6000K
 Waterproof Rate IP69K
 Housing Material diecast aluminum
 Lens Material PC
 Dimensions 1075*76*86 mm
 Operating Temperature -45°C/+60°C
 Life Span Above 50,000 hours
 Warranty 12 months

ART: BOL 8003CC

Barcode: 5901292409296



ART: BOL 8003CF

Barcode: 5901292409128

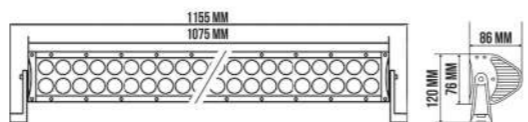

80LED CREE **20000 LUMEN**
240w **IP69K**

MODEL NUMBER	BOL 0703	BOL 1203	BOL 2403	BOL 4003	BOL 6003	BOL 8003C	BOL 8003
POWER OUTPUT	18 W	36 W	72 W	120 W	180 W	240 W	240 W
LED CHIP	3W CREE*6pcs	3W CREE*12pcs	3W CREE*24pcs	3W CREE*40pcs	3W CREE*60pcs	3W CREE*80pcs	3W CREE*80pcs
LUMENS	1200 Lm	3000 Lm	6000 Lm	11200 Lm	16800 Lm	20000 Lm	22400 Lm
DIMENSIONS	90*80*65 mm	165*80*65 mm	300*80*65 mm	540*82*87 mm	795*82*87 mm	1075*76*86 mm	1050*78*90 mm

ART: BOL 0605S

Barcode: 5901292408060



ART: BOL 0605F

Barcode: 5901292408138



Model Number BOL 0605
 Power Output 30 W
 Operating Voltage DC9 - 60V
 LED Chip 5W CREE*6pcs
 Lumens 2400Lm
 Color Temperature 6000K
 Waterproof Rate IP69K
 Housing Material diecast aluminum
 Lens Material PC
 Dimensions 193*78*40 mm
 Operating Temperature -45°C/+60°C
 Life Span Above 50,000 hours
 Warranty 12 months

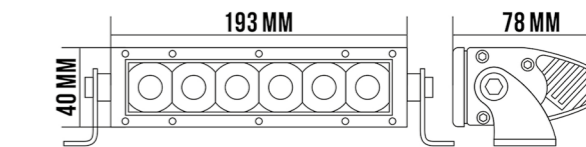

6LED CREE **2400 LUMEN** **30w** **IP69K**

ART: BOL 1005S

Barcode: 5901292408206

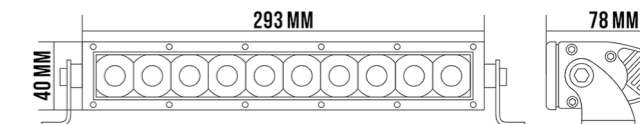

ART: BOL 1005F

Barcode: 5901292408374



Model Number BOL 1005
 Power Output 50 W
 Operating Voltage DC9 - 60V
 LED Chip 5W CREE*10pcs
 Lumens 4000Lm
 Color Temperature 6000K
 Waterproof Rate IP69K
 Housing Material diecast aluminum
 Lens Material PC
 Dimensions 293*78*40 mm
 Operating Temperature -45°C/+60°C
 Life Span Above 50,000 hours
 Warranty 12 months

ART: BOL 1005C

Barcode: 5901292408442



10LED CREE **4000 LUMEN**
50w **IP69K**

ART: BOL 2005F

Barcode: 5901292408510



ART: BOL 2005C

Barcode: 5901292408688



Model Number BOL 2005
 Power Output 100 W
 Operating Voltage DC9 - 60V
 LED Chip 5W CREE*20pcs
 Lumens 9000Lm
 Color Temperature 6000K
 Waterproof Rate IP69K
 Housing Material diecast aluminum
 Lens Material PC
 Dimensions 538*40*78 mm
 Operating Temperature -45°C/+60°C
 Life Span Above 50,000 hours
 Warranty 12 months

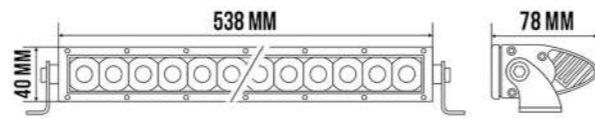

9000 LUMEN **20LED CREE** **100w** **IP69K**

ART: BOL 3005F

Barcode: 5901292408756



ART: BOL 3005C

Barcode: 5901292408824



Model Number BOL 3005
 Power Output 150 W
 Operating Voltage DC9 - 60V
 LED Chip 5W CREE*30pcs
 Lumens 13500Lm
 Color Temperature 6000K
 Waterproof Rate IP69K
 Housing Material diecast aluminum
 Lens Material PC
 Dimensions 790*40*78 mm
 Operating Temperature -45°C/+60°C
 Life Span Above 50,000 hours
 Warranty 12 months

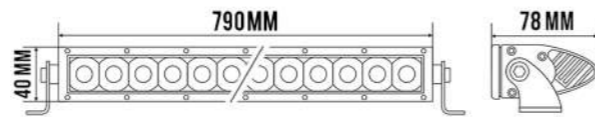

13500 LUMEN **30LED CREE** **150w** **IP69K**

ART: BOL 4005F

Barcode: 5901292408992



ART: BOL 4005C

Barcode: 5901292409050



Model Number BOL 4005
 Power Output 200 W
 Operating Voltage DC9 - 60V
 LED Chip 5W CREE*40pcs
 Lumens 18000Lm
 Color Temperature 6000K
 Waterproof Rate IP69K
 Housing Material diecast aluminum
 Lens Material PC
 Dimensions 1040*40*78 mm
 Operating Temperature -45°C/+60°C
 Life Span Above 50,000 hours
 Warranty 12 months

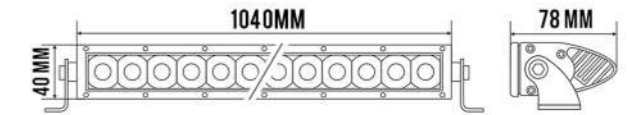

18000 LUMEN **40LED CREE** **200w** **IP69K**

MODEL NUMBER	BOL 0605	BOL 1005	BOL 2005	BOL 3005	BOL 4005
POWER OUTPUT	30 W	50 W	100 W	150 W	200 W
LED CHIP	5W CREE*6pcs	5W CREE*10pcs	5W CREE*20pcs	5W CREE*30pcs	5W CREE*40pcs
LUMENS	2400 Lm	4000 Lm	9000 Lm	13500 Lm	18000 Lm
DIMENSIONS	193*78*40 mm	293*78*40 mm	538*40*78 mm	790*40*78 mm	1040*40*78 mm

Model Number BOL 2010C
 Power Output 200 W
 Operating Voltage DC9 - 60V
 LED Chip 10W CREE*20pcs
 Lumens 14400Lm
 Color Temperature 6000K
 Waterproof Rate IP69K
 Housing Material diecast aluminum
 Lens Material PC
 Dimensions 1110*76*86 mm
 Operating Temperature -45°C/+60°C
 Life Span Above 50,000 hours
 Warranty 12 months

ART: BOL 2010FC

Barcode: 5901292410186



ART: BOL 2010CC

Barcode: 5901292410254

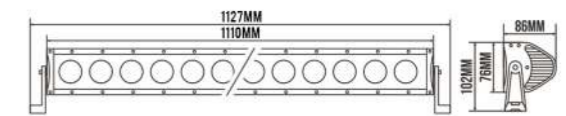

14400 LUMEN **20LED CREE** **200w**

ART: BOL 1410F

Barcode: 5901292409500



Model Number BOL 1410
 Power Output 140 W
 Operating Voltage DC9 - 60V
 LED Chip 10W CREE*14pcs
 Lumens 10080Lm
 Color Temperature 6000K
 Waterproof Rate IP69K
 Housing Material diecast aluminum
 Lens Material PC
 Dimensions 773*76*86 mm
 Operating Temperature -45°C/+60°C
 Life Span Above 50,000 hours
 Warranty 12 months

10080 LUMEN **14LED CREE** **140w**

ART: BOL 1410C

Barcode: 5901292409678

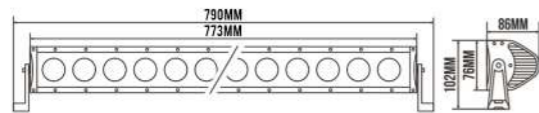

Model Number BOL 2010
 Power Output 200 W
 Operating Voltage DC9 - 60V
 LED Chip 10W CREE*20pcs
 Lumens 14400Lm
 Color Temperature 6000K
 Waterproof Rate IP69K
 Housing Material diecast aluminum
 Lens Material PC
 Dimensions 1073*76*86 mm
 Operating Temperature -45°C/+60°C
 Life Span Above 50,000 hours
 Warranty 12 months

ART: BOL 2010F

Barcode: 5901292409746



ART: BOL 2010C

Barcode: 5901292409814

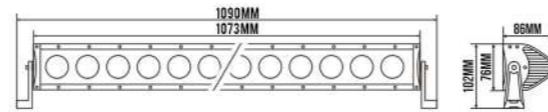

14400 LUMEN **20LED CREE** **200w**

ART: BOL 2410F

Barcode: 5901292409913



Model Number BOL 2410
 Power Output 240 W
 Operating Voltage DC9 - 60V
 LED Chip 10W CREE*24pcs
 Lumens 17280Lm
 Color Temperature 6000K
 Waterproof Rate IP69K
 Housing Material diecast aluminum
 Lens Material PC
 Dimensions 1276*76*86 mm
 Operating Temperature -45°C/+60°C
 Life Span Above 50,000 hours
 Warranty 12 months

17280 LUMEN **24LED CREE** **240w**

ART: BOL 2410C

Barcode: 5901292410018

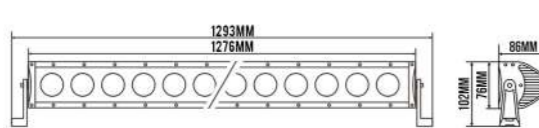

ART: BOL 2010LF

Barcode: 5901292410568



Model Number BOL 2010L
 Power Output 200 W
 Operating Voltage DC9 - 60V
 LED Chip 10W CREE*20pcs
 Lumens 14400Lm
 Color Temperature 6000K
 Waterproof Rate IP69K
 Housing Material diecast aluminum
 Lens Material PC
 Dimensions 840*62*91 mm
 Operating Temperature -45°C/+60°C
 Life Span Above 50,000 hours
 Warranty 12 months

14400 LUMEN **20LED CREE** **200w**

ART: BOL 2010LC

Barcode: 5901292410636

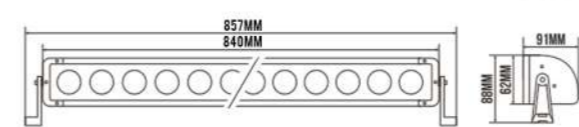

Model Number BOL 1810L
 Power Output 180 W
 Operating Voltage DC9 - 60V
 LED Chip 10W CREE*18pcs
 Lumens 12960Lm
 Color Temperature 6000K
 Waterproof Rate IP69K
 Housing Material diecast aluminum
 Lens Material PC
 Dimensions 760*62*91 mm
 Operating Temperature -45°C/+60°C
 Life Span Above 50,000 hours
 Warranty 12 months

ART: BOL 1810LF

Barcode: 5901292410322



ART: BOL 1810LC

Barcode: 5901292410490

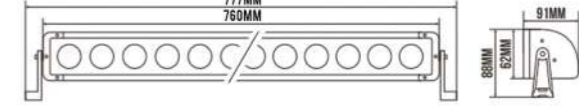

12960 LUMEN **18LED CREE** **180w**

MODEL NUMBER	BOL 1410	BOL 1810	BOL 2010F	BOL 2010FC	BOL 2010LF	BOL 2410
POWER OUTPUT	140 W	180 W	200 W	200 W	200 W	240 W
LED CHIP	10W CREE*14pcs	10W CREE*18pcs	10W CREE*20pcs	10W CREE*20pcs	10W CREE*20pcs	10W CREE*24pcs
LUMENS	10080 Lm	12960 Lm	14400 Lm	14400 Lm	14400 Lm	17280 Lm
DIMENSIONS	773*76*86 mm	760*62*91 mm	1073*76*86 mm	1110*76*86 mm	840*62*91 mm	1276*76*86 mm

BELAUTO®



ANTIFREEZE CONCENTRATE

BELAUTO®

ANTIFREEZE CONCENTRATE

ANTIFREEZE G12+ RED CONCENTRATE

Professional **Belauto Antifreeze RED G12+** is designed to reliably protect the engine from over-heating and freezing during operation. Recommended for all modern engines, including aluminum ones. Made on the basis of premium-quality monoethylene glycol and highly effective corrosion inhibitors, also contains a package of hybrid additives. Provides the optimal thermal mode of engine operation. Protects against corrosion and keeps the cooling system in perfect cleanliness. Safe for aluminum and alloys, synthetic materials and rubber; does not affect the plastic and paintwork of the car. Effectively protects the engine from freezing, "boiling" and increases its operation temperature in case of dilution one to one to -38 °C.

PROTECTION	ANTIFREEZE	WATER
-8°C	20%	80%
-15°C	30%	70%
-25°C	40%	60%
-38°C	50%	50%

**RED
G12+**



art. **AF1350**

Volume: 5 L
Barcode: 4820207181359
Packaging: 4 pcs.



art. **AF1315**

Volume: 1,5 L
Barcode: 4820207181342
Packaging: 12 pcs.



art. **AF1250**

Volume: 5 L
Barcode: 4820207181397
Packaging: 4 pcs.



art. **AF1115**

Volume: 1,5 L
Barcode: 4820207181380
Packaging: 12 pcs.

ANTIFREEZE G11 BLUE CONCENTRATE

Professional **Belauto Antifreeze BLUE G11** is designed to reliably protect the engine from over-heating and freezing during operation. Recommended for all modern engines, including aluminum ones. Made on the basis of premium-quality monoethylene glycol and highly effective corrosion inhibitors, also contains a package of hybrid additives. Provides the optimal thermal mode of engine operation. Protects against corrosion and keeps the cooling system in perfect cleanliness. Safe for aluminum and alloys, synthetic materials and rubber; does not affect the plastic and paintwork of the car. Effectively protects the engine from freezing, "boiling" and increases its operation temperature in case of dilution one to one to -38 °C.

PROTECTION	ANTIFREEZE	WATER
-8°C	20%	80%
-15°C	30%	70%
-25°C	40%	60%
-38°C	50%	50%

**BLUE
G11**

ANTIFREEZE G11 GREEN CONCENTRATE

Professional **Belauto Antifreeze Green G11** is designed to reliably protect the engine from over-heating and freezing during operation. Recommended for all modern engines, including aluminum ones. Made on the basis of premium-quality monoethylene glycol and highly effective corrosion inhibitors, also contains a package of hybrid additives. Provides the optimal thermal mode of engine operation. Protects against corrosion and keeps the cooling system in perfect cleanliness. Safe for aluminum and alloys, synthetic materials and rubber; does not affect the plastic and paintwork of the car. Effectively protects the engine from freezing, "boiling" and increases its operation temperature in case of dilution one to one to -38 °C.

PROTECTION	ANTIFREEZE	WATER
-8°C	20%	80%
-15°C	30%	70%
-25°C	40%	60%
-38°C	50%	50%

**GREEN
G11**



art. **AF1150**

Volume: 5 L
Barcode: 4820207181373
Packaging: 4 pcs.



art. **AF1217**

Volume: 1,5 L
Barcode: 4820207181366
Packaging: 12 pcs.

BELAUTO®

ANTIFREEZE

Ethylene glycol

250 000 km
extended working life

RED G12+
BLUE G11
GREEN G11

-42°C



CARBOXYLATE TECHNOLOGY

BELAUTO®

ANTIFREEZE

BELAUTO ANTIFREEZE AND COOLANT RED G12+



RED G12+ is designed to reliably protect the engine from overheating and freezing during operation. Recommended for all modern engines, including aluminum. It is made on the basis of monoethylene glycol of a premium class and highly effective corrosion inhibitors, contains a package of carboxylate additives. Provides the optimum thermal mode of operation of the engine. Protects against corrosion and keeps the cooling system in perfect cleanliness.

Safe for aluminum and alloys, synthetic materials and rubber; does not affect the plastic and paintwork of the car. Effectively protects the engine from freezing, «boiling» and increases the operating temperature to -42°C.

AF 1550

Weight: 5 kg
Barcode: 4820207181823
Packaging: 4 pcs.

AF 1510

Weight: 1 kg
Barcode: 4820207181816
Packaging: 15 pcs.

BELAUTO ANTIFREEZE AND COOLANT BLUE G11

BLUE G11 is designed to reliably protect the engine from overheating and freezing during operation. Recommended for all modern engines, including aluminum ones. It is made on the basis of monoethylene glycol of a premium class and highly effective corrosion inhibitors, contains a package of hybrid additives. Provides the optimum thermal mode of operation of the engine. Protects against corrosion and keeps the cooling system in perfect cleanliness.

Safe for aluminum and alloys, synthetic materials and rubber; does not affect the plastic and paintwork of the car. Effectively protects the engine from freezing, «boiling» and increases the operating temperature to -40°C.



AF 1650

Weight: 5 kg
Barcode: 4820207181885
Packaging: 4 pcs.

AF 1610

Weight: 1 kg
Barcode: 4820207181878
Packaging: 15 pcs.

BELAUTO ANTIFREEZE AND COOLANT GREEN G11



GREEN G11 is designed to reliably protect the engine from overheating and freezing during operation. Recommended for all modern engines, including aluminum. It is made on the basis of monoethylene glycol of a premium class and highly effective corrosion inhibitors, contains a package of hybrid additives. Provides the optimum thermal mode of operation of the engine. Protects against corrosion and keeps the cooling system in perfect cleanliness.

Safe for aluminum and alloys, synthetic materials and rubber; does not affect the plastic and paintwork of the car. Effectively protects the engine from freezing, «boiling» and increases the operating temperature to -40°C.

AF 1750

Weight: 5 kg
Barcode: 4820207181861
Packaging: 2 pcs.

AF 1710

Weight: 1 kg
Barcode: 4820207181854
Packaging: 1 pcs.



CAR HORNS

CAR HORN art. SAZ-1 TWIN TONE

Voltage: 12 V
 Frequency: 530/680 Hz
 Volume: 115/139 dB
 The distance of sound propagation: 1,5 km
 Recommended fuse: 30 A
 Connection method: 2 contacts
 Relay: +
 Packaging: 20 pcs.
 Barcode: 5901252343189

Signals are easily and quickly installed in the engine compartment - needed only one fastening element and 2 electrical connections



CAR HORN TWIN TONE art. SAZ-2

Voltage: 12 V
 Frequency: 530/680 Hz
 Volume: 115/139 dB
 The distance of sound propagation: 1,5 km
 Recommended fuse: 30 A
 Connection method: 2 contacts
 Relay: +
 Packaging: 20 pcs.
 Barcode: 5901252343257

The protective system of the intake air path provides a pleasant low and high tone



CAR HORN TWIN TONE 12V та 24V art. GAZ

Voltage: 12/24 V
 Frequency: 410/510 Hz
 Volume: 105/115 dB
 Diameter: 105 mm
 Packaging: 20/40 pcs.
 Barcode: 5901252343875/5901252344179



CAR HORN TWIN TONE art. VAZ

Voltage: 12 V
 Frequency: 410/510 Hz
 Volume: 105/115 dB
 Packaging: 40 pcs.
 Barcode: 5901252343943

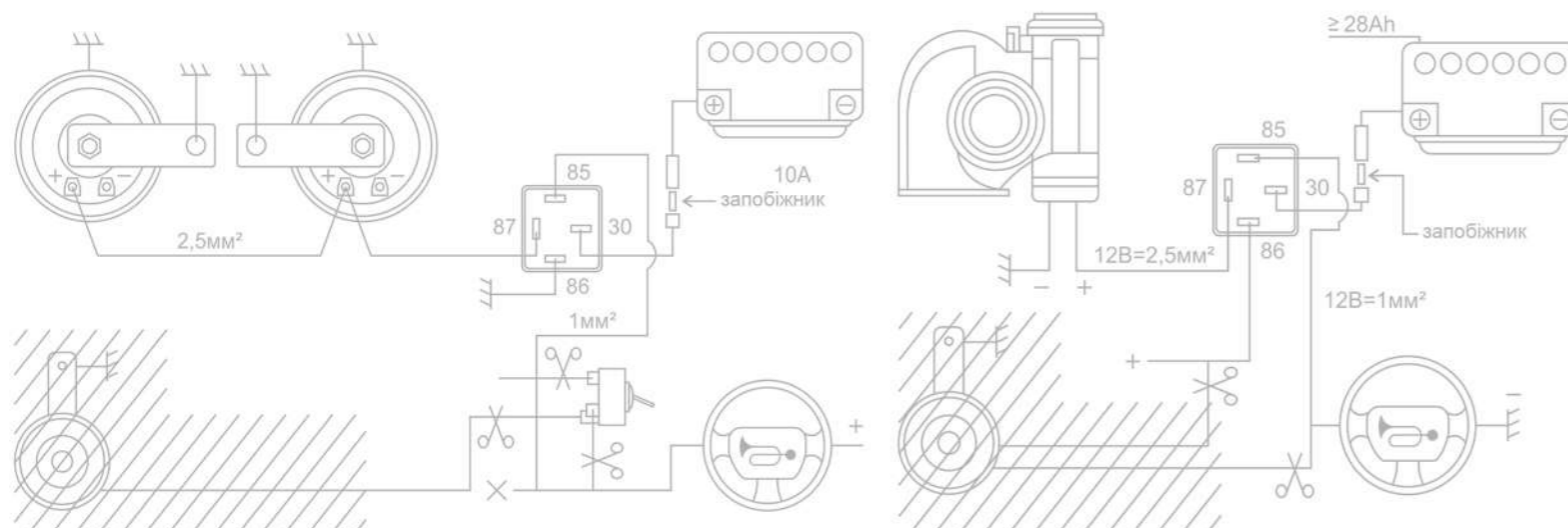

CAR HORN

TWIN TONE
art. **SAZ-6**

Voltage: 12 V
Frequency: 410/510 Hz
Volume: 105/115 dB
Diameter: 90 mm
Connection method: 2 contacts
Relay: +
Packaging: 40 pcs.
Barcode: 5901252344001



the body is made of
STRONG PLASTIC



CAR HORN

TWIN TONE
art. **SAZ-7**

Voltage: 12 V
Frequency: 410/510 Hz
Volume: 105/115 dB
Diameter: 90 mm
Connection method: 1 contact
Relay: +
Packaging: 40 pcs.
Barcode: 5901252000785

CAR HORN TWIN TONE

art. **SAZ-8**

Voltage: 12 V
Frequency: 410/510 Hz
Volume: 105/115 dB
Diameter: 90 mm
Connection method: 2 contacts
Relay: -
Packaging: 40 pcs.
Barcode: 5901252000853



Service life is more
than 100,000 times



CAR HORN

DISK
art. **SAZ-3**

Voltage: 12 V
Frequency: 335/400 Hz
Volume: 105/115 dB
Diameter: 110 mm
Connection method: 1 contact
Relay: -
Packaging: 30 pcs.
Barcode: 5901252343325

CAR HORN FANFARE 12V

art. **SAZ-4**

Voltage: 12 V
Frequency: 650 Hz
Volume: 115 dB
The distance of sound propagation: 1,5 km
Recommended fuse: 30/20 A
Length: 450 mm
Packaging: 20 pcs.
Barcode: 5901252343493



CAR HORN FANFARE 12V

art. **SAZ-10**

Voltage: 12 V
Frequency: 650 Hz
Volume: 71 dB
The distance of sound propagation: 1,5 km
Recommended fuse: 30/20 A
Length: 400 mm
Packaging: 20 pcs.
Barcode: 5901252001089



CAR HORN

DISK
art. **SAZ-9**

Voltage: 12 V
Frequency: 420 Hz
Volume: 105 dB
Diameter: 90 mm
Connection method: 1 contact
Relay: -
Packaging: 50 pcs.
Barcode: 5901252000921



art. BP-41
**Snow brush with ice scraper,
41 cm**

Pile width: 30 mm
Pile length: 55 mm
Barcode: 5902306131417
Packaging: 12 pcs.

art. BP-66
**Snow brush with ice scraper,
66 cm**

Pile width: 20 mm
Pile length: 60 mm
Barcode: 5902306131660
Packaging: 12 pcs.

art. BP-55
**Snow brush with ice scraper,
55 cm**

Pile width: 20 mm
Pile length: 60 mm
Barcode: 5902306131554
Packaging: 8 pcs.

art. BP-70
**Snow brush with ice scraper,
70 cm**

Pile width: 20 mm
Pile length: 45 mm
Barcode: 5902306131707
Packaging: 12 pcs.

art. BP-61
**Snow brush with ice scraper,
61 cm**

Pile width: 20 mm
Pile length: 60 mm
Barcode: 5902306131615
Packaging: 12 pcs.

art. BP-89
**Snow brush with ice scraper,
89 cm**

Pile width: 40 mm
Pile length: 60 mm
Barcode: 5902306131899
Packaging: 12 pcs.

art. BP-62
**Snow brush with ice scraper,
62 cm**

Pile width: 45 mm
Pile length: 60 mm
Barcode: 5902306131622
Packaging: 12 pcs.

art. BP-110
**Telescopic snow brush with ice scraper,
80-110 cm**

Pile width: 25 mm
Pile length: 60 mm
Barcode: 5902306131103
Packaging: 12 pcs.

art. BP-57

Telescopic snow brush with ice scraper, 57-70 cm



Pile width: 30 mm
Pile length: 55 mm
Barcode: 5902306132575
Packaging: 12 pcs.

art. BP-60

Snow brush with ice scraper, 60 cm



Pile width: 20 mm
Pile length: 60 mm
Barcode: 5902306131608
Packaging: 12 pcs.

art. BP-63

Snow brush with ice scraper, length 63 cm. Semicircular shape



Barcode: 5902306133633
Packaging: 12 pcs.

art. BP-76

Snow brush with scraper, 67 cm



Barcode: 5902306134678
Packaging: 12 pcs.

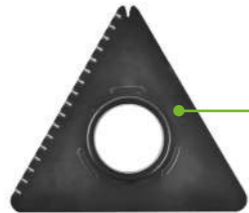

removable three-sided snow and ice scraper

art. BP-09

Snow brush MORS aluminum tube with a hard sponge on the handle, 72 cm



Barcode: 5902327771098
Packaging: 22 pcs.

art. BP-10

Snow brush TUNDRA with scraper with a hard sponge on the handle, telescopic aluminum tube, 75-105 cm



Barcode: 5902327771104
Packaging: 22 pcs.

art. BP-01

Snow brush SMALL with ice scraper, 41 cm



Barcode: 5902327771012
Packaging: 50 pcs.

art. BP-02

Snow brush BIG with ice scraper, 55 cm



Barcode: 5902327771029
Packaging: 50 pcs.

art. BP-03

Snow brush ALASKA with ice scraper, 54 cm with a hard sponge on the handle



Barcode: 5902327771036
Packaging: 50 pcs.

art. BP-04

Snow brush ALPEJKA with ice scraper, 65 cm with a hard sponge on the handle



Barcode: 5902327771043
Packaging: 25 pcs.

art. BP-05

Snow brush KANADKA with ice scraper, 63 cm with a hard sponge on the handle



Barcode: 5902327771050
Packaging: 25 pcs.

art. BP-06

Snow brush OSLO convenient plastic handle, 58 cm



Barcode: 5902327771067
Packaging: 26 pcs.

art. BP-07

Snow brush SHAMONI aluminum tube with a hard sponge on the handle, 58 cm



Barcode: 5902327771074
Packaging: 24 pcs.

art. BP-08

Snow brush PENGUIN aluminum tube with a hard sponge on the handle, 50 cm



Barcode: 5902327771081
Packaging: 20 pcs.

art. **BP-58**

Snow removal telescopic shovel with a quick-release handle, length 58-73 cm, width 30 cm.

Barcode: 5902306135583
Packaging: 12 pcs.



art. **BP-30**

Rotatable water scraper with a sponge 20 cm, telescopic handle 50-70 cm

Barcode: 5902306131301
Packaging: 12 pcs.



art. **BP-45**

Rotatable water scraper with a sponge 25 cm, telescopic handle 70-120 cm

Barcode: 5902306131455
Packaging: 12 pcs.



art. **BP-50**

Rotatable water scraper with a sponge 30cm, telescopic handle 70-120 cm

Barcode: 5902306131509
Packaging: 12 pcs.



art. **BP-31**

Telescopic handle for brush 70-130 cm

Barcode: 5902306131318
Packaging: 20 pcs.



art. **BP-32**

Telescopic handle for brush 100-170 cm

Barcode: 5902306131325
Packaging: 20 pcs.



art. **BP-33**

Telescopic handle for brush 135-300 cm

Barcode: 5902306131332
Packaging: 20 pcs.



art. **BP-34**

Brush for car washing TRUCK length 25,5 cm with water scraper



Barcode: 5902306131349
Packaging: 20 pcs.

art. **BP-35**

Brush for car washing FURGON length 25,5 cm with protective bumper



Barcode: 5902306131356
Packaging: 20 pcs.

art. **BP-36**

Brush for car washing COMBI length 20 cm with protective bumper



Barcode: 5902306131363
Packaging: 20 pcs.

art. **BP-28**

**Brush for car washing
CLASSIC**

Barcode: 4820252240100
Packaging: 40 pcs.



art. **BP-18**

**Brush for car washing
STANDARD**

Barcode: 4820252240117
Packaging: 50 pcs.



art. **BP-17**

Brush for car washing

Barcode: 4820252240124
Packaging: 50 pcs.



art. **BP-42**

Handle for brush BP-28, BP-18, BP-17 108 cm



Barcode: 5902306131219
Packaging: 24 pcs.

art. **BP-20**

Water scraper, 20 cm

Barcode: 5902306131202
Packaging: 100 pcs.



art. **BP-305**

Plastic jerry can for fuel with funnel

Volume: 5 L
Barcode: 5902306133053



art. **BP-310**

Plastic jerry can for fuel with funnel



Volume: 10 L
Barcode: 5902306133107



art. **BP-320**

Plastic jerry can for fuel with funnel



Volume: 20 L
Barcode: 5902306133206





SUMMER ACCESSORIES

art. SCW 01

Water scraper classic



Barcode: 5902327071015
Packaging: 24 pcs.

art. SCW 07

Water scraper professional



Barcode: 5902327121091
Packaging: 10 pcs.

art. SCW 02

Water scraper professional



Barcode: 5902327121022
Packaging: 20 pcs.

art. SCW 04

Water scraper



Barcode: 5902327131052
Packaging: 12 pcs.

art. SCW 06

Two-sided water scraper



Barcode: 5902327121053
Packaging: 10 pcs.

art. SCW 06/L

Two-sided water scraper long



Barcode: 5902327121060
Packaging: 16 pcs.

art. ASZ PS

Brush for car washing



Barcode: 5902327071082
Packaging: 24 pcs.

art. ASZ PET

Brush for car washing



Barcode: 5902327072089
Packaging: 24 pcs.

art. ASZ FELG

Brush for washing and cleaning rims



Barcode: 5902327072263
Packaging: 72 pcs.

art. ASZ FELG DL

Brush for washing and cleaning rims



Barcode: 5902327072270
Packaging: 36 pcs.



WINTER ACCESSORIES

art. SK 01

A simple windshield scraper with a rubber coating



Barcode: 5902327061014
Packaging: 36 pcs.

art. SK 02

Two-sided windshield scraper with a rubber coating



Barcode: 5902327061021
Packaging: 30 pcs.

art. SK 03

Windshield wiper



Barcode: 5902327061076
Packaging: 70 pcs.

art. SK 03/G

Windshield wiper with rubber water separator



Barcode: 5902327061083
Packaging: 70 pcs.

art. SK 04

Windshield wiper with handle



Barcode: 5902327061120
Packaging: 30 pcs.

art. SK 04 ROP

Windshield scraper with plush glove



Barcode: 5902327061144
Packaging: 20 pcs.

art. SK 08

Windshield wiper with handle



Barcode: 5902327061236
Packaging: 15 pcs.

art. SK11

Windshield wiper with handle



Barcode: 5902327061335
Packaging: 15 pcs.

art. SK12

Windshield wiper with handle



Barcode: 5902327062127
Packaging: 24 pcs.

ACCESSORIES



art. WS 01

Hanger, black

Barcode: 5902327111016
Packaging: 5 pcs.



art. WS 02

Hanger, chrome

Barcode: 5902327112013
Packaging: 5 pcs.

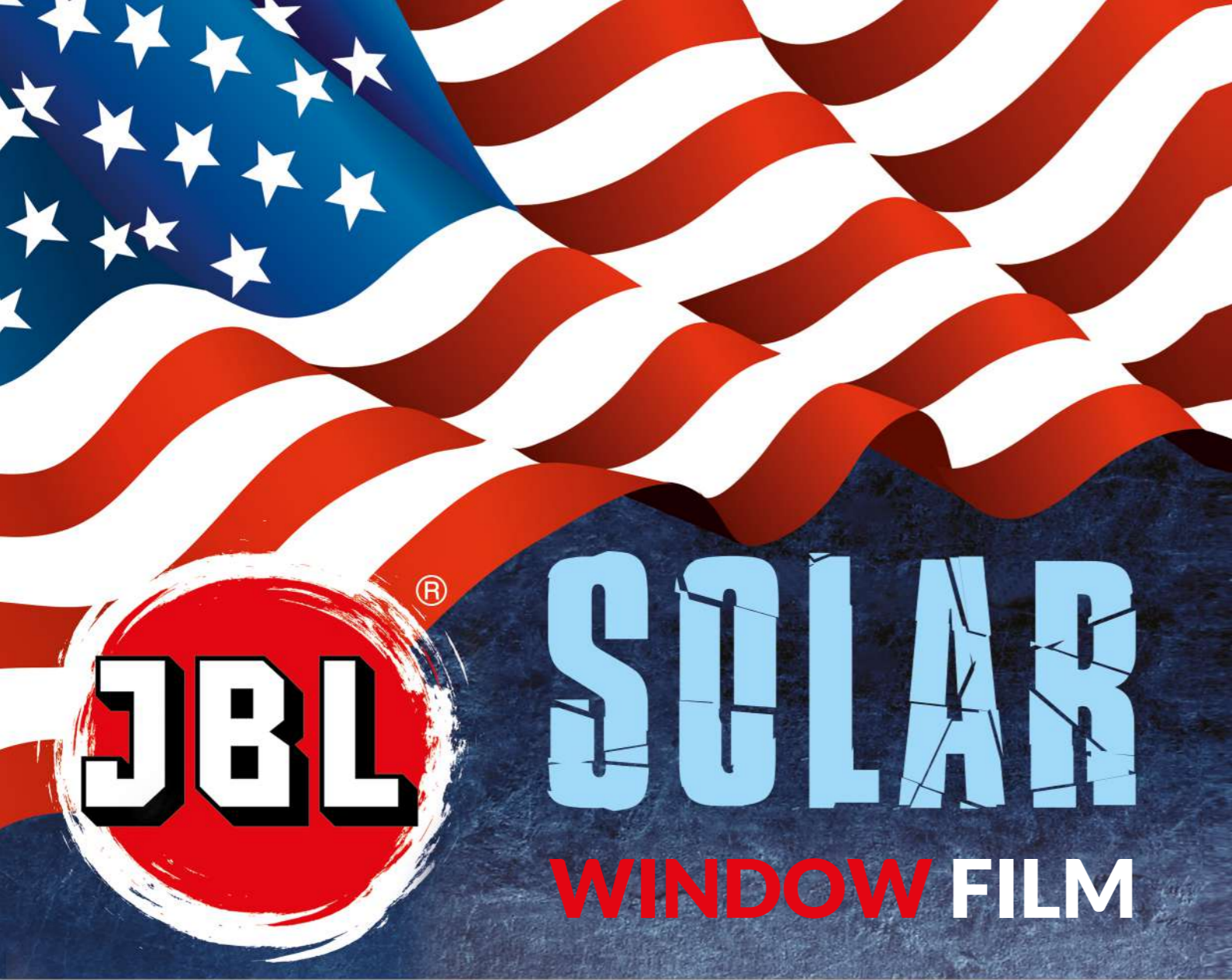

JBL®

SOLAR WINDOW FILM

Film size:
75x300 cm



Film size:
50x300 cm







Film size:
20x150 cm



DESCRIPTION:

- Up to 78% of solar energy is reflected.
- Up to 98% of ultraviolet rays (UVA and UVB) are reflected.
- The visible light transmission system consists of several levels.
- Specially designed protection will protect the glass in the event of impacts.
- To protect against scratches, the film is covered with a particularly strong anti-abrasive layer with a very smooth and strong surface.
- Effectively reduces heating - increases driving comfort.
- Passes the signal - has no conductivity, compatible with GPRS and radio communication equipment.
- The adhesive composition has absolute transparency.



-  Ultra Black
-  Super Dark Black
-  Dark Black
-  Black

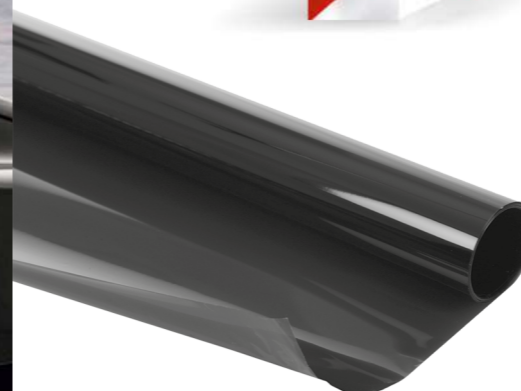

Beltex®

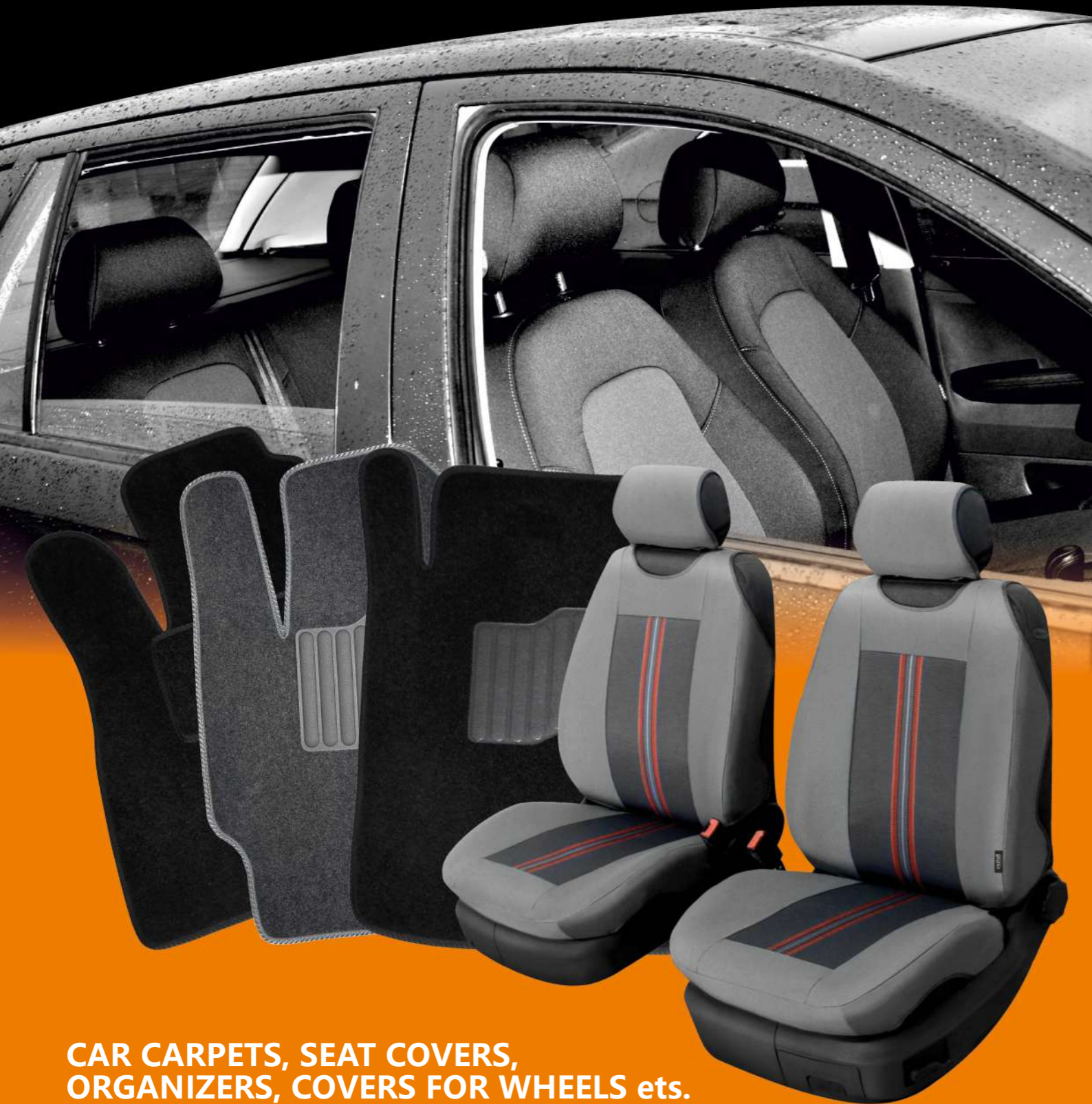

CAR CARPETS, SEAT COVERS, ORGANIZERS, COVERS FOR WHEELS etc.

GENERAL SCHEME OF MODEL CARPETS



MATERIAL FOR MODEL CARPETS

CARRERA (BELGIUM) NEEDLE PUNCH	FORTUNA (BELGIUM) TUFFED POLYPROPYLENE	RANGER (BELGIUM) TUFFED POLITEX	LION (BELGIUM) TUFFED POLITEX	CORONA (BELGIUM) TUFFED POLYPROPYLENE	EVA (UKRAINE) ETHYLENE VINYL ACETATE
BLACK	BLACK	BLACK	BLACK	BLACK	BLACK
GRAY	GRAY	GRAY	GRAY	GRAY	GRAY
ANTHRACITE	GRAPHITE		BROWN		BROWN
			BEIGE		BEIGE
GRANULAR	LATEX	LATEX	POLYTEX/RUBBER	POLYURETHANE FOAM	RED
LATEX					BLUE

PROCESSING OF THE EDGES OF MODEL CARPETS



HIGH STRENGTH TAPE SPECIALLY DESIGNED FOR CARPET PRODUCTION
PERFECTLY REPEATS THE SHAPE OF CARPET CURVES

ORIGINAL FASTENING OF MODEL CARPETS



QUALITY RUGS OF MODEL CARPETS

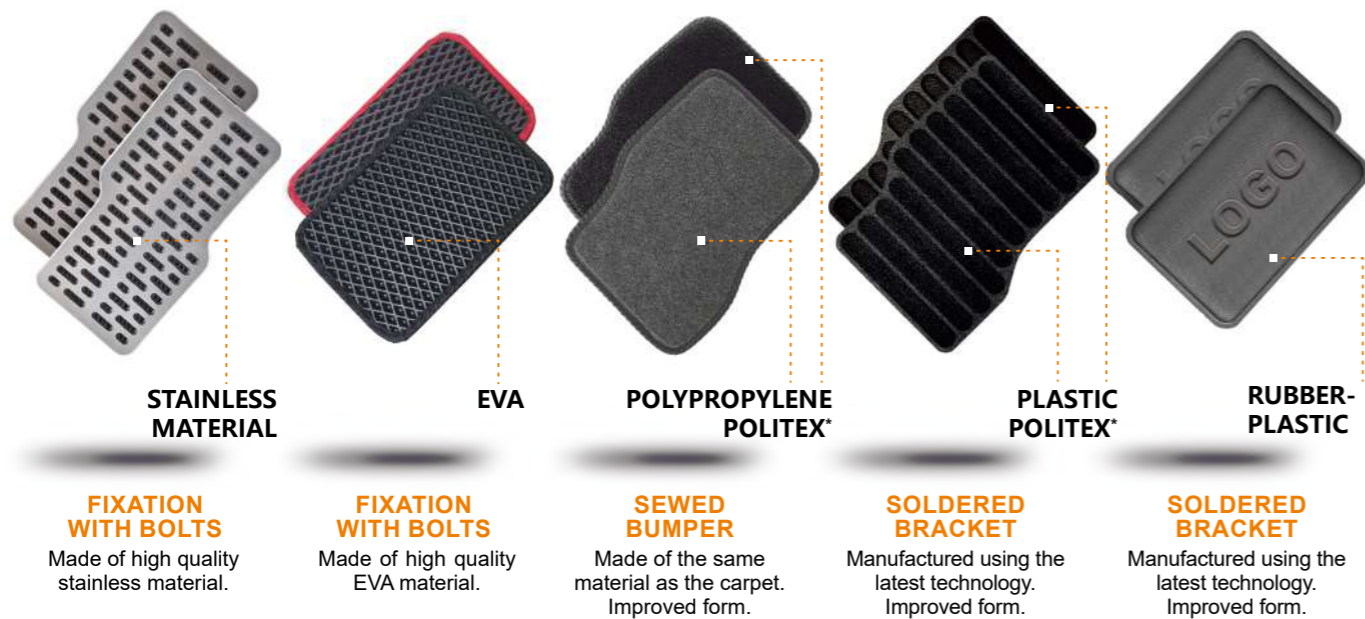

OPTIONS OF LOGOS FOR CARPETS

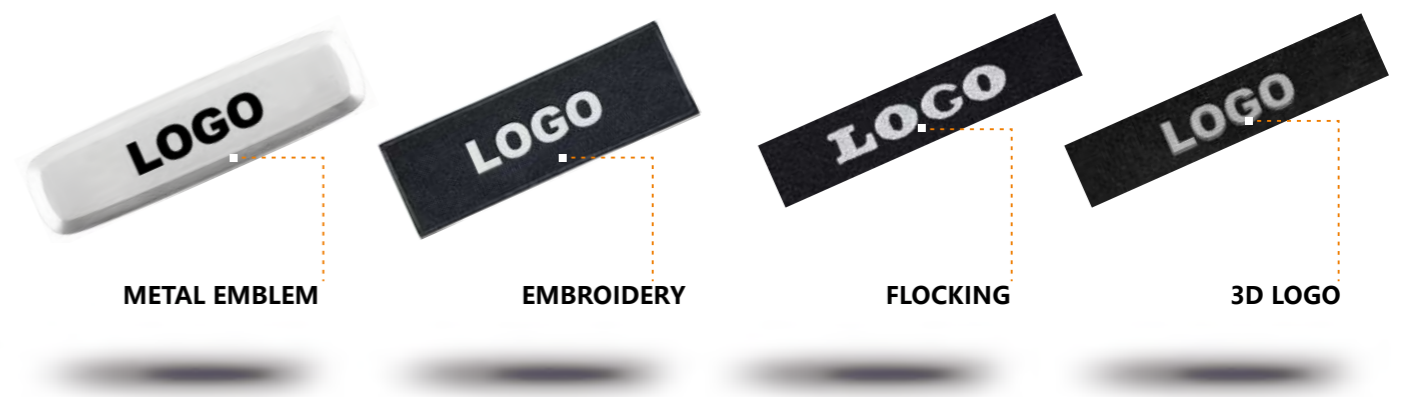

* PoliteX resource is several times higher than polypropylene resource.

CAR CARPETS
UNIVERSAL

CAR CARPETS
SETS

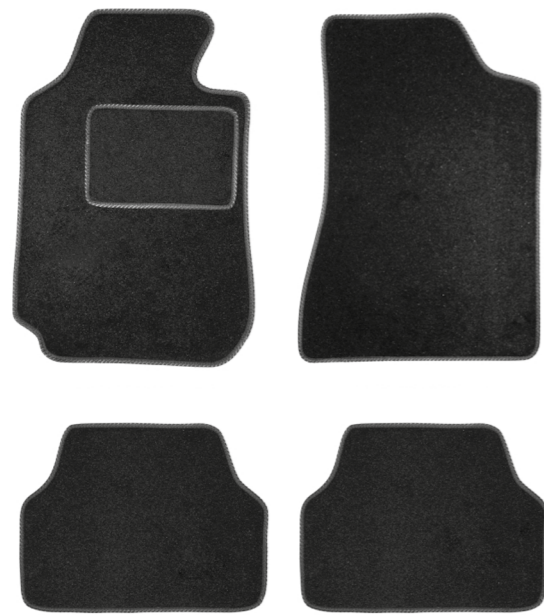

article: **BX5501**

Car carpets
type A, black, 4 pcs.

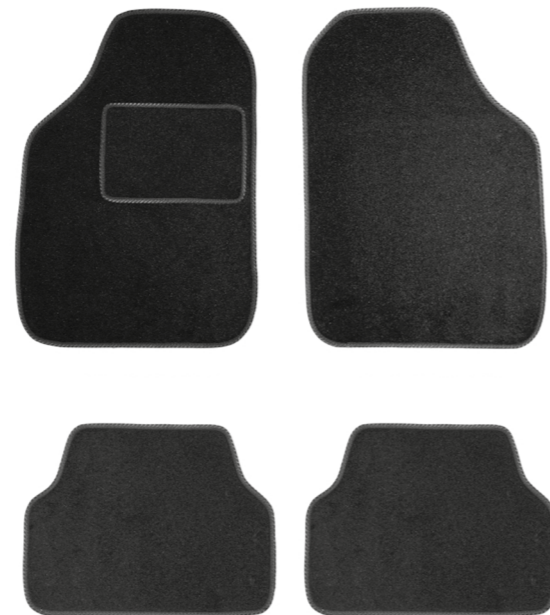

article: **BX5502**

Car carpets
type B, black, 4 pcs.



MODEL CAR CARPETS SET ACV40
black, 5 pcs.



MODEL CAR CARPETS SET X1640
black, 5 pcs.



article: **BX5504**

Car carpets
type E, black, 4 pcs.



article: **BX5503**

Car carpets
type C, black, 5 pcs.



MODEL CAR CARPETS SET SOLARIS 2011
black, 5 pcs.



MODEL CAR CARPETS SET NEW HB 2015
black, 5 pcs.

UNIVERSAL MAT AVAILABLE IN
CARPET AND EVA

OVER 1800 PATTERN AVAILABLE,
INCLUDING THE 2021-2022 MODEL RANGE.

Manhattan



Monte Carlo

**CAR SEAT CUSHION
UNIVERSAL**



www.beltex.com.ua

FULL SET

SUITABLE FOR
OF VEHICLES **99%**

Includes:
a set of covers for
the front seats - 2 pcs.
a set of covers for
the rear seats - 1 pc.
headrest covers - 5 pcs.



BX 81200
Gray
5450034812004



BX 81100
Black
5450034811007



BX 81500
Beige
5450034815005



BX 81110
Black-red
5450034811106

3D CAR SEAT CUSHION UNIVERSAL

FULL SET

SUITABLE FOR
OF VEHICLES **99%**

Includes: a set of covers for the front seats - 2 pcs.
a set of covers for the rear seats - 1 pc.
headrest covers - 5 pcs.



BX 86200
Gray
5450034862009



BX 86500
Beige
5450034865000



BX 86400
Dark green
5450034864003



BX 86100
Black
5450034861002



BX 86300
Coffee
5450034863006



Monte Carlo

**CAR SEAT CUSHION
UNIVERSAL**

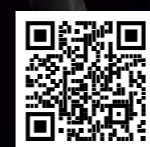

www.beltex.com.ua

FRONT SET

SUITABLE FOR
OF VEHICLES **99%**

Includes:
a set of covers for
the front seats - 2 pcs.
headrest covers - 2 pcs.



BX 81250
Gray
5450034812509



BX 81150
Black
5450034811502



BX 81550
Beige
5450034815500



BX 81160
Black-red
5450034811601

CAR SEAT CUSHION

Beltex®

Montana 3D CAR SEAT CUSHION UNIVERSAL



www.beltex.com.ua

FULL SET

SUITABLE FOR
OF VEHICLES **99%**

Includes:
a set of covers for
the front seats - 2 pcs.
a set of covers for
the rear seats - 1 pcs.
headrest covers - 5 pcs.



BX 87200
Gray
5450034872008



BX 87120
Black-brown
5450034871209



BX 87100
Black
5450034871001



BX 87110
Black-red
5450034871100

Beltex®

CAR SEAT CUSHION

Barcelona CAR SEAT CUSHION UNIVERSAL

FULL SET

SUITABLE FOR
OF VEHICLES **99%**

Includes:
a set of covers for
the front seats - 2 pcs.
a set of covers for
the rear seats - 1 pcs.
headrest covers - 5 pcs.



www.beltex.com.ua



BX 83200
Gray
5450034832002



BX 83100
Black
5450034831005



Verona CAR SEAT CUSHION UNIVERSAL



www.beltex.com.ua

FULL SET

SUITABLE FOR
OF VEHICLES **99%**

Includes:
a set of covers for
the front seats - 2 pcs.
a set of covers for
the rear seats - 1 pcs.
headrest covers - 5 pcs.



BX 82200
Gray
5450034822003



BX 82500
Beige
5450034825004



BX 82400
Dark green
5450034824007



BX 82100
Black
5450034821006



BX 82300
Coffee
5450034823000



Barcelona CAR SEAT CUSHION UNIVERSAL

FRONT SET

SUITABLE FOR
OF VEHICLES **99%**

Includes:
a set of covers for
the front seats - 2 pcs.
headrest covers - 2 pcs.



www.beltex.com.ua



BX 83250
Gray
5450034832507



BX 83150
Black
5450034831500

SEAT COVERS
UNIVERSAL

Polo



BX 15610
Red
4820240521037



BX 15210
Black
4820240521051



BX 1551
Graphite
4820240520955



BX 15110
Gray
4820240520993



FRONT SEAT COVERS
WITHOUT HEADRESTS

Fabric composition: 100% cotton
Base composition: polyurethane foam



BX 15410
Pomegranate
4820240520931



BX 15310
Blue
4820240520979



BX 15710
Dark blue
4820240521013



BX 15810
Beige
4820240520917



BX 17210
Black
4820240521044



BX 17510
Graphite
4820240520948



BX 17110
Gray
4820240520986



BX 17410
Pomegranate
4820240520924



BX 17310
Blue
4820240520962



BX 17710
Dark blue
4820240521006

REAR SEAT COVERS
WITHOUT HEADRESTS



Fabric composition: 100% cotton
Base composition: polyurethane foam

BX 17610
Red
4820240521020

SEAT COVERS
UNIVERSAL

Cotton



BX 11210
Black
4820240520764



BX 11510
Graphite
4820240520665



BX 11110
Gray
4820240520702



FRONT SEAT COVERS
WITHOUT HEADRESTS

SET 2 pcs.

BX 11310
Blue
4820240520689



BX 11410
Pomegranate
4820240520641



BX 11610
Red
4820240520740



BX 11710
Dark blue
4820240520726



BX 11810
Beige
4820240520634



A SET OF SEAT COVERS
WITHOUT HEADRESTS

SET 4 pcs.



BX 13210
Black
4820240520771



BX 13510
Graphite
4820240520672



BX 13110
Gray
4820240520719



BX 13410
Pomegranate
4820240520658



BX 13610
Red
4820240520757



BX 13710
Dark blue
4820240520733

BX 13310
Blue
4820240520696



Fabric composition: 100% cotton
Base composition: polyurethane foam

SEAT COVERS
UNIVERSAL

Delux

FRONT SEAT COVERS
WITHOUT HEADRESTS

SET 2 pcs.



BX 12210
Black
4820240520832



BX 12510
Graphite
4820240520801



BX 12110
Gray
4820240520825



BX 12610
Red
4820240521174



BX 12410
Pomegranate
4820240520795



BX 12310
Blue
4820240520818



BX 12710
Dark blue
4820240520788



SET 2 pcs.

BX 61110
Gray
4820240521075

FRONT SEAT COVERS
WITHOUT HEADRESTS



BX 61310
Graphite
4820240521068



BX 61210
Black
4820240521082

WITH CLOSED
BACK

A SET OF SEAT COVERS
WITHOUT HEADRESTS

SET 4 pcs.



BX14 610
Red
4820240520894



BX 14210
Black
4820240520900



BX 14510
Graphite
4820240520856



BX 14110
Gray
4820240520870



BX 14710
Dark blue
4820240520887



BX 14410
Pomegranate
4820240520849



BX 14310
Blue
4820240520863



SET 4 pcs.

BX 62110
Gray
4820240520474



BX 62310
Graphite
4820240520467



BX 62210
Black
4820240520481



Fabric composition: 100% cotton
Base composition: polyurethane
foam with polyester mesh

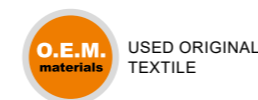

USED ORIGINAL
TEXTILE

Fabric composition: 100% cotton
Base composition: polyurethane
foam with polyester mesh

SEAT COVERS
UNIVERSAL
Comfort



SET 2 pcs.



SEAT COVERS WITHOUT HEADRESTS

ARTICLE	COLOR	BARCODE
BX 51110	Gray	4820240521136
BX 51210	Black	4820240521167
BX 51310	Graphite	4820240521112
BX 51410	Blue	4820240521129
BX 51510	Pomegranate	4820240521105
BX 51610	Red	4820240520603

SEAT COVERS WITHOUT HEADRESTS

ARTICLE	COLOR	BARCODE
BX 52110	Gray	4820240520597
BX 52210	Black	4820240521150
BX 52310	Graphite	4820240520535
BX 52410	Blue	4820240520566
BX 52510	Pomegranate	4820240521099
BX 52610	Red	4820240521143



SET 4 pcs.

A

SEAT COVERS WITHOUT HEADRESTS

ARTICLE	COLOR	BARCODE
BX 53110	Gray	4820240520573
BX 53210	Black	4820240520610
BX 53310	Graphite	4820240520511
BX 53410	Blue	4820240520542
BX 53510	Pomegranate	4820240520498

B

SEAT COVERS WITHOUT HEADRESTS

ARTICLE	COLOR	BARCODE
BX 54110	Gray	4820240520580
BX 54210	Black	4820240520627
BX 54310	Graphite	4820240520528
BX 54410	Blue	4820240520559
BX 54510	Pomegranate	4820240520504

A
SIZE

B
SIZE

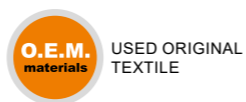

Comfort 2+1



Fabric composition: 100% cotton
Base composition: polyurethane foam with polyester mesh

HEADREST COVERS
UNIVERSAL

Polo



SET 2 pcs.

ARTICLE	COLOR	BARCODE
BX 91100	Gray	4820240520375
BX 91200	Black	4820240520399
BX 91500	Graphite	4820240520351
BX 91300	Blue	4820240520368
BX 91600	Red	4820240520382
BX 91400	Pomegranate	4820240520344

HEADREST COVERS
UNIVERSAL

Cotton



SET 2 pcs.

ARTICLE	COLOR	BARCODE
BX 92100	Gray	4820240520313
BX 92200	Black	4820240520337
BX 92500	Graphite	4820240520290
BX 92300	Blue	4820240520306
BX 92600	Red	4820240520320
BX 92400	Pomegranate	4820240520283

HEADREST COVERS
UNIVERSAL

Bolid



SET 2 pcs.

ARTICLE	COLOR	BARCODE
BX 94100	Gray	4820240520269
BX 94200	Black	4820240520276
BX 94300	Graphite	4820240520252

HEADREST COVERS
UNIVERSAL

Delux, Comfort, Comfort 2+1



SET 2 pcs.

ARTICLE	COLOR	BARCODE
BX 93100	Gray	4820240520436
BX 93200	Black	4820240520450
BX 93300	Graphite	4820240520412
BX 93400	Blue	4820240520429
BX 93600	Red	4820240520443
BX 93500	Pomegranate	4820240520405

TRUNK ORGANIZER

art. BX 38103



Small bag with 1 section. Dimensions: 44,8 x 11,8 x 18,8 cm.
Color: black, blue, red.

art. BX 38102



art. BX 38101



art. BX 38106



Large bag with 2 section. Dimensions: 52,6 x 13,2 x 18,6 cm.
Color: black, blue, red.

art. BX 38105



art. BX 38104



art. BX 36100



the possibility of applying various logos and images.

CARPET ORGANIZER BAGS

art. BX 37106

Large bag.
Dimensions: 80 x 30 x 30 cm.
Material: carpet Fortuna, Ranger.



art. BX 37105
Barcode: 4820240520023

Medium bad.
Dimensions: 60 x 30 x 30 cm.
Material: carpet Fortuna, Ranger.



art. BX 37104
Barcode: 4820240520016

Regular bag.
Dimensions: 53 x 32 x 28 cm.
Material: carpet Fortuna, Ranger.



TRANSFORMER ORGANIZER BAG



TRANSFORMER ORGANIZER BAG

art. BX 37301

Color : black
Number of sections : 2
Dimensions : 52x26x28 cm
Barcode : 4820240523147



TRANSFORMER ORGANIZER BAG

art. BX 37302

Color : black
Number of sections : 2
Dimensions : 55x29x29 cm
Barcode : 4820240523154



TRANSFORMER ORGANIZER BAG

art. BX 37303

Color : black
Number of sections : 2
Dimensions : 58x34x31 cm
Barcode : 4820240523161

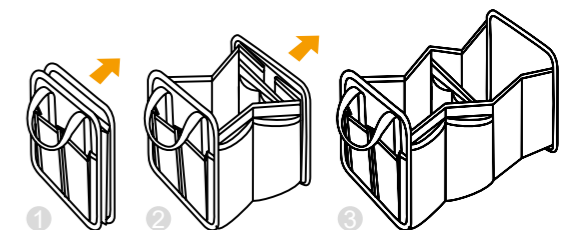

ORGANIZER BAG



art. BX 37203

Color : black
Dimensions : 40x20x25 cm
Barcode : 4820240523178

HAND LUGGAGE



ORGANIZER BAGS



ORGANIZER BAG

art. BX 37201

Color : black
Dimensions : 34x17x23 cm
Barcode : 4820240520061

M



ORGANIZER BAG

art. BX 37202

Color : black
Dimensions : 34x17x30 cm
Barcode : 4820240520078

L

BAGS FOR HYDRAULIC JACK



BAG FOR HYDRAULIC BOTTLE JACK 2-8 T

art. BX 37101

Color : black
Dimensions : 11x20x14 cm
Barcode : 4820240520030

M



BAG FOR HYDRAULIC BOTTLE JACK 10-16 T

art. BX 37102

Color : black
Dimensions : 11x22x14 cm
Barcode : 4820240520047

L



BAG FOR HYDRAULIC FLOOR JACK

art. BX 37103

Color : black
Dimensions : 45x16x15 cm
Barcode : 4820240520054





SPACE SAVER SPARE WHEEL COVER

ARTICLE	SIZE	BARCODE
BX 95600	R14 (Ø 54cm x 13,5cm)	4820240520160
BX 95700	R15 (Ø 60cm x 14,5cm)	4820240520177
BX 95866	R16 (Ø 66cm x 16cm)	4820240520184
BX 95900	R17 (Ø 71cm x 17,5cm)	4820240520191
BX 95901	R18 (Ø 76cm x 20cm)	4820240520207
BX 95902	R19 (Ø 80cm x 20cm)	4820240520214

Application:
For storing a spare wheel in the luggage compartment of the car.

- made of durable waterproof material
- prevents contamination of things in the luggage compartment
- with a handle for convenient transportation
- practical to use
- possibility of individual branding

FULL SIZE SPARE WHEEL COVER

ARTICLE	SIZE	BARCODE
BX 95500	XXL R18- R20 (Ø 85cm x 27cm)	4820240520153
BX 95400	XL R16- R20 (Ø 76cm x 25cm)	4820240520146
BX 95300	L R15- R18 (Ø 69cm x 23cm)	4820240520221
BX 95200	M R14- R15 (Ø 64cm x 21cm)	4820240520238
BX 95100	S R13- R14 (Ø 60cm x 19cm)	4820240520245

Application:
1. For storage of seasonal changeable on-board wheels and tires.
2. For a spare wheel in the luggage compartment of the car.

- made of durable waterproof material
- prevents contamination of things in the luggage compartment
- with a handle for convenient transportation
- practical to use
- possibility of individual branding



REFLECTIVE BRACELETS



art. BX 70100
Color : green
Size : 340 x 30 mm
Packaging : 1000 pcs.
Barcode : 5450034701001



art. BX 70110
Color : gray
Size : 340 x 30 mm
Packaging : 1000 pcs.
Barcode : 5450034701100

SIGNAL VESTS



art. BX 18100
Color : green
Size : XL
Density : 100 g/m²
Packaging : 100 pcs.
Barcode : 5450034181001



art. BX 19100
Color : green
Size : XXL
Density : 100 g/m²
Packaging : 100 pcs.
Barcode : 5450034191000



art. BX 18110
Color : orange
Size : XL
Density : 100 g/m²
Packaging : 100 pcs.
Barcode : 5450034181100



art. BX 19110
Color : orange
Size : XXL
Density : 100 g/m²
Packaging : 100 pcs.
Barcode : 5450034191109



REFLECTIVE ARMBAND



Color : green



Color : gray

ARTICLE	SIZE	BARCODE
BX 70200	S-size 30-35 cm	4820240523086
BX 70210	M-size 35-40 cm	4820240523093
BX 70220	L-size 40-45 cm	4820240523109

ARTICLE	SIZE	BARCODE
BX 70300	S-size 30-35 cm	4820240523116
BX 70310	M-size 35-40 cm	4820240523123
BX 70320	L-size 40-45 cm	4820240523130

URAGAN[®]

AIR COMPRESSOR



URAGAN[®]

CAR AIR COMPRESSORS

URAGAN 90210

AIR COMPRESSOR

2 YEARS
GUARANTEE



16R



DUTY CYCLE
TIME

2 Atm/Bar
2 min

Voltage: DC 12 V
Max. current: 14 A
Max. pressure: 10 bar
Power rate: 170 W
Continuous operating time: 15 min.
Maximum air flow rate: 40 l/min.
Hose length: 1 m
Power cable length: 3 m
Barcode: 5902901902108
Packaging: 8 pcs.

High-precision metal manometer

Rubber cushioning supports for improved stability and vibration absorption

Reliable and convenient plastic handle

All metal piston



Power cable with 100% copper

Plug with a fuse made of high-quality plastic

Natural rubber hose

Convenient and reliable metal connector



Additional adapters



High quality water-resistant bag is included

URAGAN 90110

AIR COMPRESSOR

Voltage: DC 12 V
 Max. current: 12 A
 Max. pressure: 7 bar
 Power rate: 150 W
 Continuous operating time: 15 min.
 Maximum air flow rate: 35 l/min.
 Hose length: 1 m
 Power cable length: 3 m
 Barcode: 5902901901101
 Packaging: 8 pcs.



URAGAN 90120

AIR COMPRESSOR

Voltage: DC 12 V
 Max. current: 14 A
 Max. pressure: 7 bar
 Power rate: 170 W
 Continuous operating time: 15 min.
 Maximum air flow rate: 37 l/min.
 Hose length: 1 m
 Power cable length: 3 m
 Barcode: 5902901901200
 Packaging: 8 pcs.



URAGAN 90130

AIR COMPRESSOR

Voltage: DC 12 V
 Max. current: 14 A
 Max. pressure: 7 bar
 Power rate: 170 W
 Continuous operating time: 15 min.
 Maximum air flow rate: 37 l/min.
 Hose length: 1 m
 Power cable length: 3 m
 Barcode: 5902901901309
 Packaging: 8 pcs.

URAGAN 90135

AIR COMPRESSOR WITH AUTOSTOP

Voltage: DC 12 V
 Max. current: 14 A
 Max. pressure: 7 bar
 Power rate: 170 W
 Continuous operating time: 15 min.
 Maximum air flow rate: 37 l/min.
 Hose length: 1 m
 Power cable length: 3 m
 Barcode: 5902901901354
 Packaging: 8 pcs.



URAGAN 90140

AIR COMPRESSOR WITH BATTERY CLAMPS

Voltage: DC 12 V
 Max. current: 16 A
 Max. pressure: 10 bar
 Power rate: 200 W
 Continuous operating time: 15 min.
 Maximum air flow rate: 40 l/min.
 Hose length: 5,7 m
 Power cable length: 3 m
 Barcode: 5902901901408
 Packaging: 8 pcs.

URAGAN 90170

AIR COMPRESSOR 2 CYLINDERS with battery clamps

Voltage: DC 12 V
 Max. current: 30 A
 Max. pressure: 10 bar
 Power rate: 360 W
 Continuous operating time: 15 min.
 Maximum air flow rate: 85 l/min.
 Hose length: 5,7 m
 Power cable length: 3 m
 Barcode: 5902901901705
 Packaging: 8 pcs.



URAGAN 90180 AIR COMPRESSOR

Voltage: DC 12 V
Max. current: 14 A
Max. pressure: 7 bar
Power rate: 170 W
Continuous operating time: 15 min.
Maximum air flow rate: 35 l/min.
Hose length: 1 m
Power cable length: 3 m
Barcode: 5902901901804
Packaging: 12 pcs.



URAGAN 90190 AIR COMPRESSOR MANOMETER BACKLIGHT

Voltage: DC 12 V
Max. current: 12 A
Max. pressure: 7 bar
Power rate: 150 W
Continuous operating time: 15 min.
Maximum air flow rate: 35 l/min.
Hose length: 1 m
Power cable length: 3 m
Barcode: 5902901901903
Packaging: 10 pcs.



LED
SIGNAL LAMP

URAGAN 90100 CIGARETTE LIGHTER SOCKET with battery clamps

Voltage: DC 12 V
Max. current: 15 A
Power cable length: 30 cm
Barcode: 5902901901002
Packaging: 200 pcs.



URAGAN 90200 CIGARETTE LIGHTER SOCKET with battery clamps

Voltage: DC 12/24 V
Max. current: 20 A
Power cable length: 30 cm
Barcode: 5902901902009
Packaging: 200 pcs.

High quality
fuse 20A



STORM

AIR COMPRESSOR



Bi POWER

AIR COMPRESSOR

Art. 20 400 **2 CYLINDERS**

power rate 360 W	max. pressure 10 BAR	maximum air flow rate 85 l/min.
2 Atm	R17	24 MONTHS

Voltage: DC 12 V
Max. current: 30 A
Max. pressure: 10 bar
Power rate: 360 W
Continuous operating time: 15 min.
Maximum air flow rate: 85 l/min.
Hose length: 5,7 m
Power cable length: 3 m
Barcode: 5902902320406
Packaging: 8 pcs.



Convenient handle for carrying

Hose made of high-quality frost-resistant PU



All-metal piston

Reliable metal connector

High quality manometer with drain valve

High-quality clamps for reliable and strong fixation

power rate 170 W
max. pressure 10 BAR
maximum air flow rate 40 l/min.



2 Atm
2 min
R16
24 MONTHS

MAX POWER

AIR COMPRESSOR

Art. 20 500
Voltage: DC 12 V
Max. current: 14 A
Max. pressure: 10 bar
Power rate: 170 W
Continuous operating time: 15 min.
Maximum air flow rate: 40 l/min.
Hose length: 3 m
Power cable length: 1 m
Barcode: 5902902420502
Packaging: 8 pcs.

BIG POWER

AIR COMPRESSOR

Art. 20 320 **AUTOSTOP**

Voltage: DC 12 V
Max. current: 14 A
Max. pressure: 10 bar
Power rate: 170 W
Continuous operating time: 15 min.
Maximum air flow rate: 37 l/min.
Hose length: 1 m
Power cable length: 3 m
Barcode: 5902902220324
Packaging: 8 pcs.

power rate 170 W
max. pressure 10 BAR
maximum air flow rate 37 l/min.



2 Atm
3 min
R16
24 MONTHS

BIG POWER

AIR COMPRESSOR

Art. 20 310
Voltage: DC 12 V
Max. current: 14 A
Max. pressure: 10 bar
Power rate: 170 W
Continuous operating time: 15 min.
Maximum air flow rate: 37 l/min.
Hose length: 1 m
Power cable length: 3 m
Barcode: 5902902120310
Packaging: 8 pcs.

power rate 170 W
max. pressure 10 BAR
maximum air flow rate 37 l/min.



2 Atm
3 min
R16
24 MONTHS

power rate 170 W
max. pressure 10 BAR
maximum air flow rate 37 l/min.



2 Atm
3 min
R16
24 MONTHS

BIG POWER

AIR COMPRESSOR

Art. 20 300
Voltage: DC 12 V
Max. current: 14 A
Max. pressure: 10 bar
Power rate: 170 W
Continuous operating time: 15 min.
Maximum air flow rate: 37 l/min.
Hose length: 1 m
Power cable length: 3 m
Barcode: 5902902020306
Packaging: 8 pcs.

AIR POWER

AIR COMPRESSOR

Art. 20 200
Voltage: DC 12 V
Max. current: 12 A
Max. pressure: 7 bar
Power rate: 150 W
Continuous operating time: 15 min.
Maximum air flow rate: 35 l/min.
Hose length: 1 m
Power cable length: 3 m
Barcode: 5902901920201
Packaging: 8 pcs.

power rate 150 W
max. pressure 7 BAR
maximum air flow rate 35 l/min.



2 Atm
3 min
R15
24 MONTHS



CIGARETTE LIGHTER SOCKET WITH BATTERY CLAMPS

Art. 20 100
Voltage: DC 12 V
Max. current: 15 A
Power cord length: 30 cm
Barcode: 5902901920102
Packaging: 200 pcs.

COMPACT POWER AIR COMPRESSOR

Art. 20 700

power rate 80 W	max. pressure 7 BAR	maximum air flow rate 12 l/min.
2 Atm 7 min	R16 	GUARANTEE 12 MONTHS

Voltage: DC 12 V
Max. current: 7 A
Max. pressure: 7 bar
Power rate: 80 W
Continuous operating time: 15 min.
Maximum air flow rate: 12 l/min.
Hose length: 0,51 m
Power cable length: 3 m
Barcode: 5902901920706
Packaging: 6 pcs.



Compact case

Two-color lantern

+ TIRE REPAIR KIT



COMPACT POWER AIR COMPRESSOR

Art. 20 600

power rate 60 W	max. pressure 7 BAR	maximum air flow rate 15 l/min.
2 Atm 5 min	R16 	GUARANTEE 12 MONTHS

Voltage: DC 12 V
Max. current: 7 A
Max. pressure: 7 bar
Power rate: 60 W
Continuous operating time: 15 min.
Maximum air flow rate: 15 l/min.
Hose length: 0,45 m
Power cable length: 3 m
Barcode: 5902901920607
Packaging: 20 pcs.



Compact case



SOLAR[®] electric

AUTOMOTIVE LED LAMPS



LED HEADLIGHT LAMPS



SET 2 pcs.

8000LM 60W

art. 8304

H4 ZES 2ndG

Input power: 60 W
 Operating voltage: DC 9-32V
 Lumens: 8000 Lm
 IP rate: IP65
 Color temperature: 6500K
 Leds quantity: 16 pcs.
 Light source model: ZES 2nd G
 Barcode: 8590745583040
 Packaging: 50 pcs.

LED HEADLIGHT LAMPS



art. 8601

H1 CREE 1860

Input power: 40 W
 Operating voltage: DC 12-24V
 Lumens: 6000 Lm
 IP rate: IP65
 Color temperature: 6000K
 Leds quantity: 6 pcs.
 Light source model: Cree 1860
 Barcode: 8590745586010
 Packaging: 50 pcs.



art. 8604

H4 CREE 1860

Input power: 40 W
 Operating voltage: DC 12-24V
 Lumens: 6000 Lm
 IP rate: IP65
 Color temperature: 6500K
 Leds quantity: 12 pcs.
 Light source model: Cree 1860
 Barcode: 8590745586041
 Packaging: 50 pcs.

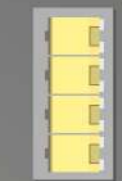

CHIP ZES 2ndG LED CHIP

Aviation grade 6063 aluminum paired with a cooling fan provides good heat dissipation and protection against overheating.



cooling system WITH FAN

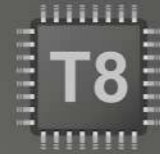

INTEGRATED INTELLIGENT DRIVER

Double circuit protection.
 Millisecond startup.
 Built-in intelligent overheating protection circuit.

IP65 IP RATE

>30000 hours LIFE SPAN

99% SUITABLE FOR ALL VEHICLES



CREE MULTI-CORE TECHNOLOGY LED CHIP

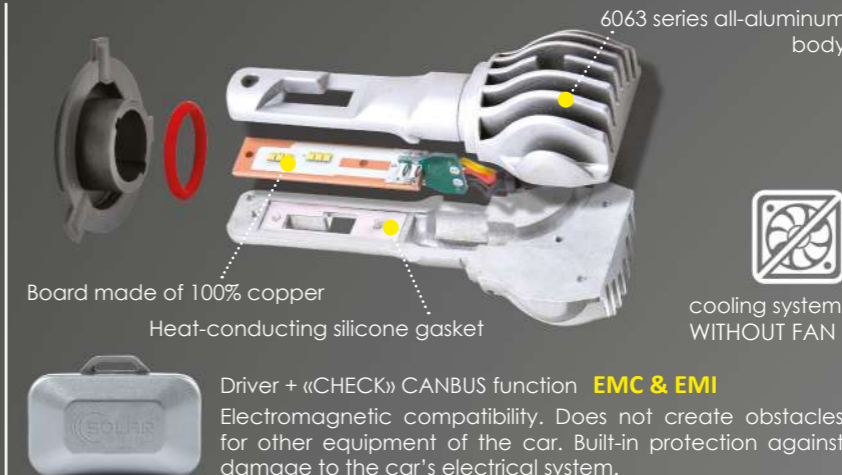

IP65 IP RATE

>50000 hours LIFE SPAN

99% SUITABLE FOR ALL VEHICLES



art. 8307

H7 ZES 2ndG

Input power: 60 W
 Operating voltage: DC 9-32V
 Lumens: 8000 Lm
 IP rate: IP65
 Color temperature: 6500K
 Leds quantity: 8 pcs.
 Light source model: ZES 2nd G
 Barcode: 8590745583071
 Packaging: 50 pcs.



art. 8311

H11 ZES 2ndG

Input power: 60 W
 Operating voltage: DC 9-32V
 Lumens: 8000 Lm
 IP rate: IP65
 Color temperature: 6500K
 Leds quantity: 8 pcs.
 Light source model: ZES 2nd G
 Barcode: 8590745583118
 Packaging: 50 pcs.



art. 8607

H7 CREE 1860

Input power: 40 W
 Operating voltage: DC 12-24V
 Lumens: 6000 Lm
 IP rate: IP65
 Color temperature: 6500K
 Leds quantity: 6 pcs.
 Light source model: Cree 1860
 Barcode: 8590745586072
 Packaging: 50 pcs.



art. 8611

H11 CREE 1860

Input power: 40 W
 Operating voltage: DC 12-24V
 Lumens: 6000 Lm
 IP rate: IP65
 Color temperature: 6500K
 Leds quantity: 6 pcs.
 Light source model: Cree 1860
 Barcode: 8590745586119
 Packaging: 50 pcs.

LED HEADLIGHT LAMPS

art. **8201**



H1 **CSP 1860**

Input power: 40 W
 Operating voltage: 12-24V
 Lumens: 5000 Lm
 IP rate: IP67
 Color temperature: 6000K
 Leds quantity: 6 pcs.
 Light source model: CSP 1860
 Barcode: 8590745582012
 Packaging: 50 pcs.



art. **8204**

H4 **CSP 1860**

Input power: 40 W
 Operating voltage: 12-24V
 Lumens: 5000 Lm
 IP rate: IP67
 Color temperature: 6000K
 Leds quantity: 12 pcs.
 Light source model: CSP 1860
 Barcode: 8590746082047
 Packaging: 50 pcs.

LED HEADLIGHT LAMPS

art. **8101**



H1 **CSP 19x19**

Input power: 50 W
 Operating voltage: DC 9-32V
 Lumens: 4000 Lm
 IP rate: IP65
 Color temperature: 6000K
 Leds quantity: 6 pcs.
 Light source model: CSP 19x19
 Barcode: 8590745581015
 Packaging: 50 pcs.



art. **8104**

H4 **CSP 19x19**

Input power: 50 W
 Operating voltage: DC 9-32V
 Lumens: 4000 Lm
 IP rate: IP65
 Color temperature: 6000K
 Leds quantity: 12 pcs.
 Light source model: CSP 19x19
 Barcode: 8590745581046
 Packaging: 50 pcs.



CSP LED CHIP



AVIATION ALUMINUM 6063
 Aviation aluminum 6063 series provides good heat transfer and protection against overheating.

cooling system WITHOUT FAN



IP RATE

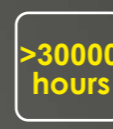

>30000 hours

LIFE SPAN



SEOLU CSP CHIP (19x19) LED CHIP



AVIATION ALUMINUM 6063
 Aviation aluminum 6063 series provides good heat transfer and protection against overheating.

cooling system WITHOUT FAN



IP RATE



>30000 hours

LIFE SPAN

art. **8207**



H7 **CSP 1860**

Input power: 40 W
 Operating voltage: 12-24V
 Lumens: 5000 Lm
 IP rate: IP67
 Color temperature: 6000K
 Leds quantity: 6 pcs.
 Light source model: CSP 1860
 Barcode: 8590745682071
 Packaging: 50 pcs.



art. **8211**

H11 **CSP 1860**

Input power: 40 W
 Operating voltage: 12-24V
 Lumens: 5000 Lm
 IP rate: IP67
 Color temperature: 6000K
 Leds quantity: 6 pcs.
 Light source model: CSP 1860
 Barcode: 8590745782115
 Packaging: 50 pcs.



art. **8107**

H7 **CSP 19x19**

Input power: 50 W
 Operating voltage: DC 9-32V
 Lumens: 4000 Lm
 IP rate: IP65
 Color temperature: 6000K
 Leds quantity: 6 pcs.
 Light source model: CSP 19x19
 Barcode: 8590745581077
 Packaging: 50 pcs.



art. **8111**

H11 **CSP 19x19**

Input power: 50 W
 Operating voltage: DC 9-32V
 Lumens: 4000 Lm
 IP rate: IP65
 Color temperature: 6000K
 Leds quantity: 6 pcs.
 Light source model: CSP 19x19
 Barcode: 8590745581114
 Packaging: 50 pcs.

art. **8205**



HB3 (9005) **CSP 1860**

Input power: 40 W
 Operating voltage: 12-24V
 Lumens: 5000 Lm
 IP rate: IP67
 Color temperature: 6000K
 Leds quantity: 6 pcs.
 Light source model: CSP 1860
 Barcode: 8590745882051
 Packaging: 50 pcs.



art. **8206**

HB4 (9006) **CSP 1860**

Input power: 40 W
 Operating voltage: 12-24V
 Lumens: 5000 Lm
 IP rate: IP67
 Color temperature: 6000K
 Leds quantity: 6 pcs.
 Light source model: CSP 1860
 Barcode: 8590745982065
 Packaging: 50 pcs.



art. **8105**

HB3 (9005) **CSP 19x19**

Input power: 50 W
 Operating voltage: DC 9-32V
 Lumens: 4000 Lm
 IP rate: IP65
 Color temperature: 6000K
 Leds quantity: 6 pcs.
 Light source model: CSP 19x19
 Barcode: 8590745581053
 Packaging: 50 pcs.



art. **8106**

HB4 (9006) **CSP 19x19**

Input power: 50 W
 Operating voltage: DC 9-32V
 Lumens: 4000 Lm
 IP rate: IP65
 Color temperature: 6000K
 Leds quantity: 6 pcs.
 Light source model: CSP 19x19
 Barcode: 8590745581060
 Packaging: 50 pcs.

LED HEADLIGHT LAMPS



6000LM 50W

art. **8804**

H4 **ZES 2ndG**

Input power: **50 W**
 Operating voltage: **DC 9-32V**
 Lumens: **6000 Lm**
 IP rate: **IP67**
 Color temperature: **4300K/6500K/8000K**
 Leds quantity: **10 pcs.**
 Light source model: **ZES 2nd G**
 Barcode: **8590745588045**
 Packaging: **50 pcs.**

SET 2 pcs.



CHIP ZES 2ndG LED CHIP



AVIATION ALUMINUM 7

Aviation aluminum 7 series provides good heat transfer and protection against overheating.

cooling system WITHOUT FAN



+2 COLORED LIGHT FILTERS included



IP67 IP RATE

>30000 hours LIFE SPAN

99% SUITABLE FOR ALL VEHICLES



art. **8807**

H7 **ZES 2ndG**

Input power: **50 W**
 Operating voltage: **DC 9-32V**
 Lumens: **6000 Lm**
 IP rate: **IP67**
 Color temperature: **4300K/6500K/8000K**
 Leds quantity: **6 pcs.**
 Light source model: **ZES 2nd G**
 Barcode: **8590745588076**
 Packaging: **50 pcs.**

SET 2 pcs.

Front parking lights (☀️)

- SL 1330, SL 1331, SL 1336, SL 1335, SL 1332
- SL 1333, SL 1337, SL 1334, SL 1345, SL 1347
- SL 1348, SL 1340, SL 1343, SL 1341, SL 1342

Front turn signals (↔️)

- SL 1387, SL 1389, SL 1385, SL 1380, SL 1381, SL 1382

Interior lights (💡)

- SL 1330, SL 1331, SL 1336, SL 1335, SL 1332, SL 1333
- SL 1337, SL 1334, SL 1345, SL 1347, SL 1348, SL 1340
- SL 1343, SL 1341, SL 1342, SL 1360, SL 1361, SL 1362
- SL 1363, SL 1350, SL 1351, SL 1352, SL 1353

Dashboard lights (💡)

- SL 1330, SL 1336, SL 1337
- SL 1334, SL 1340

Side turn signals (↔️)

- SL 1330, SL 1336, SL 1337
- SL 1334, SL 1340

Stop signals (STOP)

- SL 1387, SL 1389, SL 1385, SL 1380
- SL 1381, SL 1382, SL 1395, SL 1386

Stop signals (STOP)

- SL 1330, SL 1336, SL 1337
- SL 1334, SL 1340, SL 1339
- SL 1338

Trunk lights (💡)

- SL 1360, SL 1361, SL 1362, SL 1363, SL 1350
- SL 1351, SL 1352, SL 1353, SL 1380, SL 1381, SL 1382

Reverse lights (↻️)

- SL 1339, SL 1338, SL 1395, SL 1387, SL 1389, SL 1385

Rear signal lights (💡)

- SL 1339, SL 1338, SL 1395, SL 1387, SL 1389, SL 1385, SL 1386

Rear fog lights (💡)

- SL 1339, SL 1338, SL 1395, SL 1387, SL 1389, SL 1385, SL 1386

Rear turn signals (↔️)

- SL 1339, SL 1338, SL 1395, SL 1387
- SL 1389, SL 1385

Number plate lights (💡)

- SL 1330, SL 1331, SL 1336, SL 1335, SL 1332, SL 1333
- SL 1337, SL 1334, SL 1345, SL 1347, SL 1348, SL 1340
- SL 1343, SL 1341, SL 1342, SL 1360, SL 1361, SL 1362
- SL 1363, SL 1350, SL 1351, SL 1352, SL 1353

LED SIGNAL LAMPS 12V

PREMIUM LINE

art. **SL 1395**

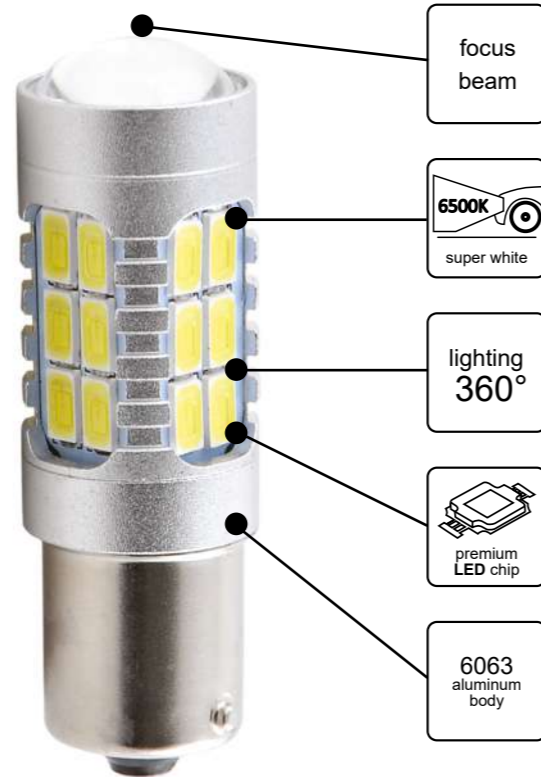
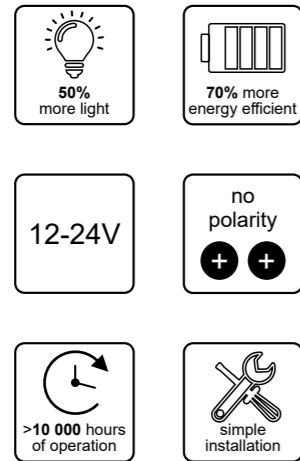

art. **SL 1345**



12V
10 SMD 5730 + lens White
Base: T10 W2,1x9,5d
Barcode: 8590745513450
Packaging: 2 pcs.



art. **SL 1334**



12V
12 SMD 3014 White
Base: T10 W2,1x9,5d
Barcode: 8590745513344
Packaging: 2 pcs.



art. **SL 1337**



12V
1 COB White
Base: T10 W2,1x9,5d
Barcode: 8590745513375
Packaging: 2 pcs.



art. **SL 1339**



12V
5 SMD 2835 White
Base: T10 W2,1x9,5d
Barcode: 8590745513399
Packaging: 2 pcs.



art. **SL 1338**



12V
7 SMD 2835 White
Base: T10 W2,1x9,5d
Barcode: 8590745513382
Packaging: 2 pcs.



art. **SL 1330**



12V
5 SMD 5050 White
Base: T10 W2,1x9,5d
Barcode: 8590745513306
Packaging: 2 pcs.



art. **SL 1342**



12V
10 SMD 3030 SSC
10W 250lm CANBUS White
Base: T10 W2,1x9,5d
Barcode: 8590745513429
Packaging: 2 pcs.



art. **SL 1340**



12V
1SMD 3030
CANBUS White
Base: T10 W2,1x9,5d
Barcode: 8590745513405
Packaging: 2 pcs.



art. **SL 1341**



12V
6 SMD 3030 SSC
6W 250lm CANBUS White
Base: T10 W2,1x9,5d
Barcode: 8590745513412
Packaging: 2 pcs.



art. **SL 1331**



12V
5 SMD 5050 White
Base: T8,5 BA9s
Barcode: 8590745513313
Packaging: 2 pcs.



art. **SL 1336**



12V
9 SMD 5730 White
Base: T10 W2,1x9,5d
Barcode: 8590745513368
Packaging: 2 pcs.



art. **SL 1335**



12V
9 SMD 5730 White
Base: T8,5 BA9s
Barcode: 8590745513320
Packaging: 2 pcs.



art. **SL 1343**



12V
2 Cree XBD
120 lm White
Base: T10 W2,1x9,5d
Barcode: 8590745513436
Packaging: 2 pcs.



art. **SL 1347**



12V
6 SMD 5730 + lens
CANBUS White
Base: T10 W2,1x9,5d
Barcode: 8590745513474
Packaging: 2 pcs.



art. **SL 1348**



12V
10 SMD 5730 + lens
CANBUS White
Base: T10 W2,1x9,5d
Barcode: 8590745513481
Packaging: 2 pcs.



art. **SL 1332**



12V
1 SMD 1W White
Base: T10 W2,1x9,5d
Barcode: 8590745513320
Packaging: 2 pcs.



art. **SL 1333**



12V
1 SMD 1W White
Base: T8,5 BA9s
Barcode: 8590745513337
Packaging: 2 pcs.



art. **SL 1360**



12V
6 SMD 5730
CANBUS White
Base: SV8,5 T11x36
Barcode: 8590745513603
Packaging: 2 pcs.



art. **SL 1361**



12V
6 SMD 5730
CANBUS White
Base:
SV8,5 T11x41
Barcode:
8590745513610
Packaging: 2 pcs.



art. **SL 1362**



12V
6 SMD 2835
CANBUS White
Base:
SV8,5 T11x36
Barcode:
8590745513627
Packaging: 2 pcs.



art. **SL 1363**



12V
9 SMD 2835
CANBUS White
Base:
SV8,5 T11x39
Barcode:
8590745513634
Packaging: 2 pcs.



art. **SL 1380**



12V
8 SMD 2535 White
Base:
G18,5 BA15s
Barcode:
8590745513801
Packaging: 2 pcs.



art. **SL 1381**



12V
22 SMD 3020 White
Base:
G18,5 BA15s
Barcode:
8590745513818
Packaging: 2 pcs.



art. **SL 1382**



12V
1 COB White
Base:
G18,5 BA15s
Barcode:
8590745513825
Packaging: 2 pcs.



art. **SL 1350**



12V
6 SMD 2835 White
Base:
SV8,5 T11x36
Barcode:
8590745513504
Packaging: 2 pcs.



art. **SL 1351**



12V
6 SMD 2835 White
Base:
SV8,5 T11x39
Barcode:
8590745513511
Packaging: 2 pcs.



art. **SL 1352**



12V
4 SMD 5730 White
Base:
SV8,5 T11x36
Barcode:
8590745513528
Packaging: 2 pcs.



LED SIGNAL LAMPS
24V

PREMIUM LINE

art. **SL 2530**



24V
5 SMD 5050 White
Base:
T10 W2,1x9,5d
Barcode:
8590745525309
Packaging: 2 pcs.



art. **SL 2531**



24V
5 SMD 5050 White
Base:
T8,5 BA9s
Barcode:
8590745525316
Packaging: 2 pcs.



art. **SL 1353**



12V
4 SMD 5730 White
Base:
SV8,5 T11x39
Barcode:
8590745513535
Packaging: 2 pcs.



art. **SL 1395**



12V
27 SMD 5730 CANBUS
Non-Polar White
Base:
S25 BA15s
Barcode:
8590745513955
Packaging: 2 pcs.



art. **SL 1387**



12V
20 SMD 5730 White
Base:
S25 BA15s
Barcode:
8590745513870
Packaging: 2 pcs.



art. **SL 2532**



24V
1SMD 1W White
Base:
T10 W2,1x9,5d
Barcode:
8590745525323
Packaging: 2 pcs.



art. **SL 2533**



24V
1SMD 1W White
Base:
T8,5 BA9s
Barcode:
8590745525330
Packaging: 2 pcs.



art. **SL 2550**



24V
6 SMD 2835 White
Base:
SV8,5 T11x36
Barcode:
8590745525507
Packaging: 2 pcs.



art. **SL 1385**



12V
50 SMD 3030 White
Base:
S25 BA15s
Barcode:
8590745513856
Packaging: 2 pcs.



art. **SL 1386**



12V
50 SMD 3030 White
Base:
S25 BAY15d
Barcode:
8590745513863
Packaging: 2 pcs.



art. **SL 1389**



12V
48 SMD 2835
CANBUS White
Base:
S25 BA15s
Barcode:
8590745513894
Packaging: 2 pcs.



art. **SL 2551**



24V
6 SMD 2835 White
Base:
SV8,5 T11x39
Barcode:
8590745525514
Packaging: 2 pcs.



art. **SL 2581**



24V
22 SMD 3020 White
Base:
G18,5 BA15s
Barcode:
8590745525811
Packaging: 2 pcs.



art. **SL 2582**



24V
1 COB White
Base:
G18,5 BA15s
Barcode:
8590745525811
Packaging: 2 pcs.



LED SIGNAL LAMPS 12V

T5 1 LED White 12V



Article	Base	Barcode	Packaging
LF 101_P	W2x4,6d	8590745611019	20 pcs.

T5 1 LED Red 12V



Article	Base	Barcode	Packaging
LF 103_P	W2x4,6d	8590745611033	20 pcs.

T10 1 LED Blue 12V



Article	Base	Barcode	Packaging
LF 112_P	W2,1x9,5d	8590745611125	10 pcs.

T5 1 SMD 3528 White 12V



Article	Base	Barcode	Packaging
LF 202_P	W2x4,6d	8590745612023	20 pcs.

T10 1 SMD 1W White 12V



Article	Base	Barcode	Packaging
LS 241_P	W2,1x9,5d	8590745612412	10 pcs.
LS 241_B2	W2,1x9,5d	8590745622411	2 pcs.

T10 6 SMD 5630+Lens White 12V



Article	Base	Barcode	Packaging
LS 285_P	W2,1x9,5d	8590745612658	10 pcs.
LS 285_B2	W2,1x9,5d	8590745622657	2 pcs.

T10 10 SMD 5630 White 12V



Article	Base	Barcode	Packaging
LS 287_P	W2,1x9,5d	8590745612870	10 pcs.
LS 287_B2	W2,1x9,5d	8590745622879	2 pcs.

T5 1 LED Blue 12V



Article	Base	Barcode	Packaging
LF 102_P	W2x4,6d	8590745611026	20 pcs.

T10 1 LED White 12V



Article	Base	Barcode	Packaging
LF 111_P	W2,1x9,5d	8590745611118	10 pcs.

T5 1 SMD 5050 White 12V



Article	Base	Barcode	Packaging
LS 201_P	W2x4,6d	8590745612016	20 pcs.

T5 COB 0,5W White 12V



Article	Base	Barcode	Packaging
LC 340_P	W2x4,6d	8590745613402	10 pcs.

T10 1 SMD 1W+Lens White 12V



Article	Base	Barcode	Packaging
LS 265_P	W2,1x9,5d	8590745612658	10 pcs.
LS 265_B2	W2,1x9,5d	8590745622657	2 pcs.

T10 6 SMD 5630 White 12V



Article	Base	Barcode	Packaging
LS 286_P	W2,1x9,5d	8590745612658	10 pcs.
LS 286_B2	W2,1x9,5d	8590745622657	2 pcs.

T10 1 SMD 1,5W Lens White 12V



Article	Base	Barcode	Packaging
LS 288_P	W2,1x9,5d	8590745612887	10 pcs.
LS 288_B2	W2,1x9,5d	8590745622886	2 pcs.

T10 1 SMD 0,5W Lens White 12V



Article	Base	Barcode	Packaging
LS 289_P	W2,1x9,5d	8590745612894	10 pcs.
LS 289_B2	W2,1x9,5d	8590745622893	2 pcs.

T10 1 SMD 1W White 12V



Article	Base	Barcode	Packaging
LC 341_P	W2,1x9,5d	8590745613419	10 pcs.
LC 341_B2	W2,1x9,5d	8590745623418	2 pcs.

T10 5D COB-02 White 12V



Article	Base	Barcode	Packaging
LC 343_P	W2,1x9,5d	8590745613433	10 pcs.
LC 343_B2	W2,1x9,5d	8590745623432	2 pcs.

T10 9 SMD 5050 White 12V



Article	Base	Barcode	Packaging
LS 277_P	W2,1x9,5d	8590745612771	10 pcs.
LS 277_B2	W2,1x9,5d	8590745622770	2 pcs.

T10 1 SMD 5050 White 12V



Article	Base	Barcode	Packaging
LS 245_P	W2,1x9,5d	8590745612450	10 pcs.
LS 245_B2	W2,1x9,5d	8590745622459	2 pcs.

T10 2 SMD 5630 White 12V



Article	Base	Barcode	Packaging
LS 283_P	W2,1x9,5d	8590745612832	10 pcs.

T8,5 1 SMD 1W White 12V



Article	Base	Barcode	Packaging
LS 242_P	BA9s	8590745612429	10 pcs.

T10 2 SMD 5630 White 12V



Article	Base	Barcode	Packaging
LS 290_P	W2,1x9,5d	8590745612900	10 pcs.
LS 290_B2	W2,1x9,5d	8590745622909	2 pcs.

T10 1 SMD Lens White 12V



Article	Base	Barcode	Packaging
LC 342_P	W2,1x9,5d	8590745613426	10 pcs.
LC 342_B2	W2,1x9,5d	8590745623425	2 pcs.

T10 5 SMD 5050 White 12V



Article	Base	Barcode	Packaging
LS 243_P	W2,1x9,5d	8590745612436	10 pcs.
LS 243_B2	W2,1x9,5d	8590745622435	2 pcs.

T10 5D 5SMD 5630 White 12V



Article	Base	Barcode	Packaging
LS 284_P	W2,1x9,5d	8590745612849	10 pcs.

T10 1 SMD 5630 White 12V



Article	Base	Barcode	Packaging
LS 282_P	W2,1x9,5d	8590745612825	10 pcs.

T10 1 COB 0,6W White 12V



Article	Base	Barcode	Packaging
LC 331_P	W2,1x9,5d	8590745623319	10 pcs.

T8,5 5 SMD 5050 White 12V



Article	Base	Barcode	Packaging
LS 246_P	BA9s	8590745612467	10 pcs.

T8,5 9 SMD 5050 White 12V



Article	Base	Barcode	Packaging
LS 278_P	BA9s	8590745612788	10 pcs.
LS 278_B2	BA9s	8590745622787	2 pcs.

T8,5 1 COB 0,6W White 12V



Article	Base	Barcode	Packaging
LC 335_P	BA9s	8590745613358	10 pcs.

SV8,5 4 SMD 1,5W White 12V



Article	Base	Barcode	Packaging
LS 251_P	T11x39mm	8590745612511	10 pcs.

SV8,5 6 SMD 5050 White 12V



Article	Base	Barcode	Packaging
LS 253_P	T11x39mm	8590745612535	10 pcs.

SV8,5 3 SMD 5050 White 12V



Article	Base	Barcode	Packaging
LS 255_P	T11x39mm	8590745612559	10 pcs.

SV8,5 6 SMD 3528 White 12V



Article	Base	Barcode	Packaging
LS 276_P	T11x39mm	8590745612764	10 pcs.
LS 276_B2	T11x39mm	8590745622763	2 pcs.

SV8,5 1 COB 1W White 12V



Article	Base	Barcode	Packaging
LC 337_P	T11x39mm	8590745613372	10 pcs.

T8,5 1 SMD 5050 White 12V



Article	Base	Barcode	Packaging
LS 247_P	BA9s	8590745612474	10 pcs.
LS 247_B2	BA9s	8590745622473	2 pcs.

SV8,5 4 SMD 5050 White 12V



Article	Base	Barcode	Packaging
LS 250_P	T11x36mm	8590745612504	10 pcs.

SV8,5 6 SMD 5050 White 12V



Article	Base	Barcode	Packaging
LS 252_P	T11x36mm	8590745612528	10 pcs.

SV8,5 3 SMD 5050 White 12V



Article	Base	Barcode	Packaging
LS 254_P	T11x36mm	8590745612542	10 pcs.

SV8,5 6 SMD 3528 White 12V



Article	Base	Barcode	Packaging
LS 275_P	T11x36mm	8590745612757	10 pcs.
LS 275_B2	T11x36mm	8590745622756	2 pcs.

SV8,5 1 COB 1W White 12V



Article	Base	Barcode	Packaging
LC 336_P	T11x36mm	8590745613365	10 pcs.

SV8,5 1 COB 3 SMD White 12V



Article	Base	Barcode	Packaging
LC 338_P	T11x39mm	8590745613389	10 pcs.

SV8,5 1 COB 3 SMD White 12V



Article	Base	Barcode	Packaging
LC 339_P	T11x39mm	8590745613396	10 pcs.

SV8,5 1 COB 3W White 12V



Article	Base	Barcode	Packaging
LC 334_P	T11x39mm	8590745613341	10 pcs.

G18,5 22 SMD 3020 White 12V



Article	Base	Barcode	Packaging
LS 223_P	BA15s	8590745612238	4 pcs.

T10 5 SMD 3528 White 12V



Article	Base	Barcode	Packaging
LS 258_P	Canbus	8590745612580	10 pcs.

T10 1SMD COB 70lm White 12V



Article	Base	Barcode	Packaging
LC 344_B2	W2.1x9.5d	8590745623449	2 pcs.

T10 1COB 1,5W 70LM White 12V/24V



Article	Base	Barcode	Packaging
LC 346_B2	W2.1x9.5d	8590745623463	2 pcs.

T10 1SMD 3030 92lm White 12V



Article	Base	Barcode	Packaging
LS 293_B2	W2.1x9.5d	8590745622930	2 pcs.

SV8,5 1 COB 3W White 12V



Article	Base	Barcode	Packaging
LC 333_P	T11x36mm	8590745613334	10 pcs.

G18,5 5 SMD 5050 White 12V



Article	Base	Barcode	Packaging
LS 221_P	BA15s	8590745612214	4 pcs.

G18,5 1 COB 3W White 12V



Article	Base	Barcode	Packaging
LC 332_P	T11x36mm	8590745612757	10 pcs.
LC 332_B2	T11x36mm	8590745622756	2 pcs.

SV8,5 3 SMD 5050 White 12V



Article	Base	Barcode	Packaging
LS 260_P	T11x36mm Canbus	8590745612603	10 pcs.

S25 1COB 100LM White 12V



Article	Base	Barcode	Packaging
LC 345_B2	BA15s	8590745623456	2 pcs.

S25 COB 100lm White 12V



Article	Base	Barcode	Packaging
LC 365_B2	BA15d	8590745623654	2 pcs.

S25 38SMD 4140 140LM White 12V



Article	Base	Barcode	Packaging
LS 294_B2	BA15s	8590745622947	2 pcs.

S25 18SMD 5730 120LM White 12V/24V



Article	Base	Barcode	Packaging
LS 295_B2	BA15s	8590745622954	2 pcs.

T10 1SMD 3W White 12V



Article	Base	Barcode	Packaging
LS 297_B2	W2.1x9.5d	8590745622978	2 pcs.

LED SIGNAL LAMPS 24V

T8,5 1 SMD 1W White 24V



Article	Base	Barcode	Packaging
LS 262_P	BA9s	8590745612627	10 pcs.

G18,5 22 SMD 3020 White 24V



Article	Base	Barcode	Packaging
LS 224_P	BA15s	8590745612245	4 pcs.

1COB 0.6W White 24V



Article	Base	Barcode	Packaging
LC 357_P	BA9s	8590745613570	10 pcs.

T10 1COB 0.6W White 24V



Article	Base	Barcode	Packaging
LC 359_P	W2.1x9.5d	8590745613594	10 pcs.

S25 8SMD 2835 White 12V/24V



Article	Base	Barcode	Packaging
LS 296_B2	BA15s	8590745622961	2 pcs.

T10 1SMD 1,5W White 12V



Article	Base	Barcode	Packaging
LS 298_B2	W2.1x9.5d	8590745622985	2 pcs.

T10 SMD 1W White 24V



Article	Base	Barcode	Packaging
LS 261_P	W2,1x9,5	8590745612610	10 pcs.

G18,5 5 SMD 5050 White 24V



Article	Base	Barcode	Packaging
LS 222_P	BA15s	859074561222	4 pcs.

SV8.5 5 SMD 5050 White 24V



Article	Base	Barcode	Packaging
LS 271_P	T11x36mm	8590745612719	10 pcs.

T5 5 SMD 5050 White 24V



Article	Base	Barcode	Packaging
LC 358_P	W2x4.6d	8590745613587	10 pcs.

G18.5 1COB 3W White 24V



Article	Base	Barcode	Packaging
LC 360_P	BA15s	8590745613600	4 pcs.

SV8.5 1COB 3W White 24V



Article	Base	Barcode	Packaging
LC 361_P	T11x36	8590745613617	10 pcs.

SV8.5 6smd 3528 White 24V



Article	Base	Barcode	Packaging
LC 363_P	T11x36	8590745613631	10 pcs.

SV8.5 1COB 3W White 24V



Article	Base	Barcode	Packaging
LC 362_P	T11x39	8590745613624	10 pcs.

SV8.5 6smd 3528 White 24V



Article	Base	Barcode	Packaging
LC 364_P	T11x39	8590745613648	10 pcs.

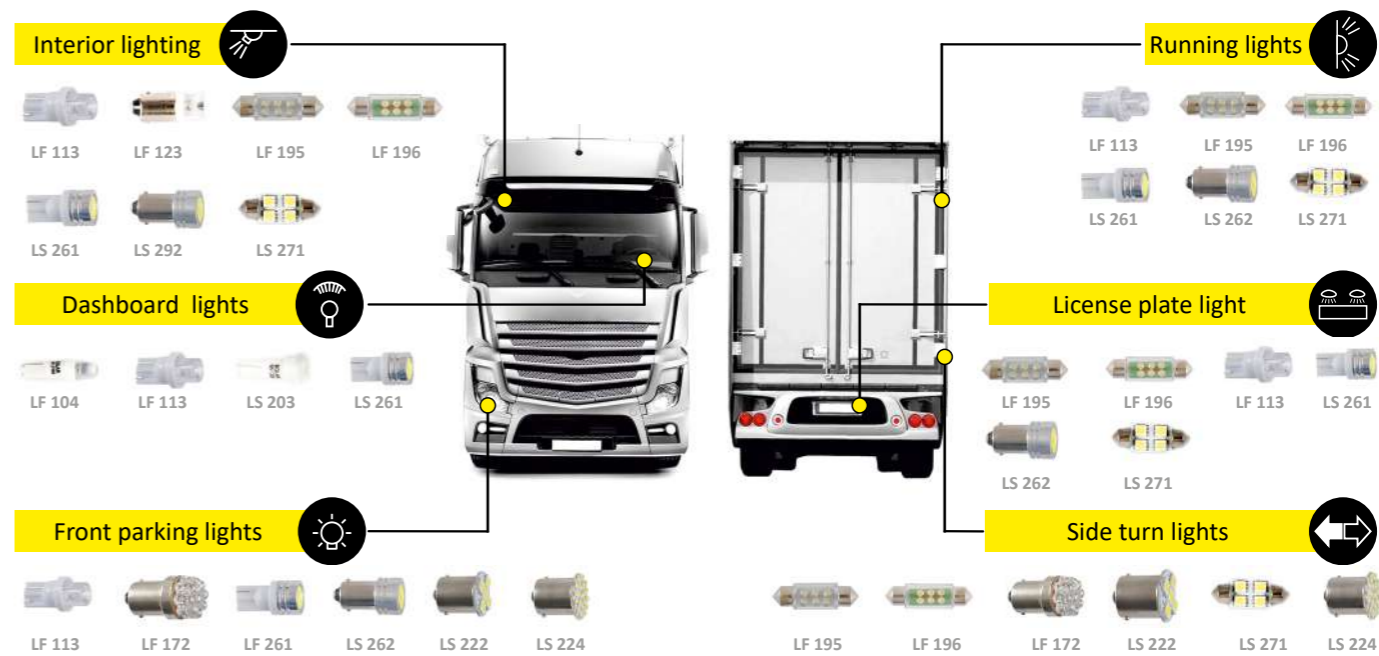

D Series Xenon HID

for standard xenon lamps



D1S

Article	V	W	Base	Color Temperature
8114	85	35	PK32d-2	4300K
8115	85	35	PK32d-2	5000K
8116	85	35	PK32d-2	6000K



D1R

Article	V	W	Base	Color Temperature
8124	85	35	PK32d-3	4300K
8125	85	35	PK32d-3	5000K
8126	85	35	PK32d-3	6000K



D2S

Article	V	W	Base	Color Temperature
8214	85	35	P32d-2	4300K
8215	85	35	P32d-2	5000K
8216	85	35	P32d-2	6000K



D2R

Article	V	W	Base	Color Temperature
8224	85	35	P32d-3	4300K
8225	85	35	P32d-3	5000K
8226	85	35	P32d-3	6000K

H Series Xenon HID

to replace halogen lamps



H1

Article	V	W	Base	Color Temperature
1143	85	35	P14,5s	4300K
1150	85	35	P14,5s	5000K
1160	85	35	P14,5s	6000K



H3

Article	V	W	Base	Color Temperature
1343	85	35	PK22s	4300K
1350	85	35	PK22s	5000K
1360	85	35	PK22s	6000K



H4 Bi-Xenon

Article	V	W	Base	Color Temperature
1443	85	35	P43t-38	4300K
1450	85	35	P43t-38	5000K
1460	85	35	P43t-38	6000K



H7

Article	V	W	Base	Color Temperature
1743	85	35	PX26d	4300K
1750	85	35	PX26d	5000K
1760	85	35	PX26d	6000K



H11

Article	V	W	Base	Color Temperature
1943	85	35	PGJ19-2	4300K
1950	85	35	PGJ19-2	5000K
1960	85	35	PGJ19-2	6000K



H27/2 (881)

Article	V	W	Base	Color Temperature
8840	85	35	PGJ13	4300K
8850	85	35	PGJ13	5000K
8860	85	35	PGJ13	6000K



HB3 (9005)

Article	V	W	Base	Color Temperature
9543	85	35	P20d	4300K
9550	85	35	P20d	5000K
9560	85	35	P20d	6000K



HB4 (9006)

Article	V	W	Base	Color Temperature
9643	85	35	P22d	4300K
9650	85	35	P22d	5000K
9660	85	35	P22d	6000K

H Series Xenon HID CERAMIC

to replace halogen lamps



H1

Article	V	W	Base	Color Temperature
1151	85	35	P14,5s	5000K
1161	85	35	P14,5s	6000K



H3

Article	V	W	Base	Color Temperature
1351	85	35	PK22s	5000K
1361	85	35	PK22s	6000K



H7

Article	V	W	Base	Color Temperature
1751	85	35	PX26d	5000K
1761	85	35	PX26d	6000K

AC HID Ballast

ballast system



SLIM BALLAST

Article	Voltage	Current	Power	Connector	Barcode	Packaging
1540	9-16V	13.2A	35W	KET	8590745515409	50



SLIM BALLAST

Article	Voltage	Current	Power	Connector	Barcode	Packaging
1550	9-32V	13.2A	35W	KET	8590745515508	50



SLIM PREMIUM BALLAST

Article	Voltage	Current	Power	Connector	Barcode	Packaging
1560	9-16V	13.2A	35W	KET	8590745515607	50



SLIM CANBUS PREMIUM BALLAST

Article	Voltage	Current	Power	Connector	Barcode	Packaging
1570	9-16V	13.2A	35W	KET	8590745515706	50

Additional equipment



Article	Voltage	Power	Item	Barcode	Packaging
1440	12V	35W	H4 Bi-Xenon Wire + Relay, switching wires	8590745514402	1
1442	24V	55W	H4 Bi-Xenon Wire + Relay, switching wires	8590745514426	1



Article	Voltage	Item	Barcode	Packaging
1445	12V	Adapter KET-AMP	8590745514457	2

Article	Voltage	Item	Barcode	Packaging
1555	12V	Canbus 9-16V HID Warning Canceller Capacitor	8590745515553	2

Xenon HID Conversion Kits

H1

Article	V	W	Ballast	Color Temperature
4143	85	35	slim	4300K
4150	85	35	slim	5000K
4160	85	35	slim	6000K

H3

Article	V	W	Ballast	Color Temperature
4343	85	35	slim	4300K
4350	85	35	slim	5000K
4360	85	35	slim	6000K

H4 Bi-Xenon

Article	V	W	Ballast	Color Temperature
4443	85	35	slim	4300K
4450	85	35	slim	5000K
4460	85	35	slim	6000K

H7

Article	V	W	Ballast	Color Temperature
4743	85	35	slim	4300K
4750	85	35	slim	5000K
4760	85	35	slim	6000K

H8

Article	V	W	Ballast	Color Temperature
4850	85	35	slim	5000K
4860	85	35	slim	6000K

H11

Article	V	W	Ballast	Color Temperature
4950	85	35	slim	5000K
4960	85	35	slim	6000K

HB3

Article	V	W	Ballast	Color Temperature
4550	85	35	slim	5000K
4560	85	35	slim	6000K

HB4

Article	V	W	Ballast	Color Temperature
4650	85	35	slim	5000K
4660	85	35	slim	6000K

H27/2

Article	V	W	Ballast	Color Temperature
4950	85	35	slim	5000K





HALOGEN LAMPS



Starlight
+30%
3200K

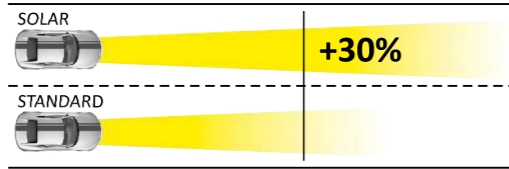

AVAILABLE IN:

H1, H3, H4, H7, H8,
H11, H13, HB3, HB4,
H27/1, H27/2

Star +60
+60%
3700K

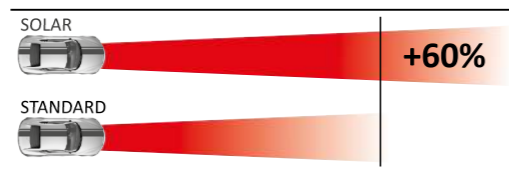

AVAILABLE IN:

H1, H3, H4, H7

StarBlue
+30%
4200K



AVAILABLE IN:

H1, H3, H4, H7, H11,
HB3, HB4

Rally
+30%
3200K

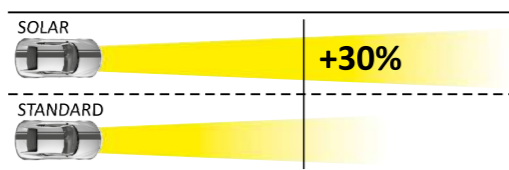

AVAILABLE IN:

H3, H4, H7



H1 Starlight +30%

Article	V	W	Base	Packaging
1201	12	55	P14,5s	CP
1201B1	12	55	P14,5s	B1



H1 Star +60%

Article	V	W	Base	Packaging
1231	12	55	P14,5s	CP
1231S2	12	55	P14,5s	S2



H1 StarBlue 4200K

Article	V	W	Base	Packaging
1241	12	55	P14,5s	CP
1241S2	12	55	P14,5s	S2



H1 Rally+30%

Article	V	W	Base	Packaging
1221	12	80	PK22s	CP



H4 Starlight +30%

Article	V	W	Base	Packaging
1204	12	60/55	P43t-38	CP
1204B1	12	60/55	P43t-38	B1
1224	12	60/55	P45t-41	CP



H4 Star +60%

Article	V	W	Base	Packaging
1234	12	60/55	P43t-38	CP
1234B1	12	60/55	P43t-38	B1
1234S2	12	60/55	P43t-38	S2



H4 StarBlue 4200 K

Article	V	W	Base	Packaging
1244	12	60/55	P43t-38	CP
1244B1	12	60/55	P43t-38	B1
1244S2	12	60/55	P43t-38	S2



H3 Starlight +30%

Article	V	W	Base	Packaging
1203	12	55	PK22s	CP
1203B1	12	55	PK22s	B1



H3 Star +60%

Article	V	W	Base	Packaging
1233	12	55	PK22s	CP
1233S2	12	55	PK22s	S2



H3 StarBlue 4200K

Article	V	W	Base	Packaging
1243	12	55	PK22s	CP
1243S2	12	55	PK22s	S2



H3 Rally+30%

Article	V	W	Base	Packaging
1213	12	80	PK22s	CP



H7 Starlight +30%

Article	V	W	Base	Packaging
1207	12	55	PX26d	CP
1207B1	12	55	PX26d	B1



H7 Star +60%

Article	V	W	Base	Packaging
1237	12	55	PX26d	CP
1237B1	12	55	PX26d	B1
1237S2	12	55	PX26d	S2



H7 StarBlue 4200 K

Article	V	W	Base	Packaging
1247	12	55	PX26d	CP
1247B1	12	55	PX26d	B1
1247S2	12	55	PX26d	S2



H4 Rally+30%

Article	V	W	Base	Packaging
1214	12	100/90	P43t-38	CP



H7 Rally+30%

Article	V	W	Base	Packaging
1217	12	100	PX26d	CP



H8 Starlight +30%

Article	V	W	Base	Packaging
1208	12	35	PGJ19-1	CP



H13 Starlight +30%

Article	V	W	Base	Packaging
1218	12	60/55	P26.4t	CP



H11 Starlight +30%

Article	V	W	Base	Packaging
1211	12	55	PGJ19-2	CP



H11 StarBlue 4200K

Article	V	W	Base	Packaging
1281	12	55	PGJ19-2	CP



HB3 Starlight +30%

Article	V	W	Base	Packaging
1205	12	65	P20d	CP



HB3 StarBlue 4200K

Article	V	W	Base	Packaging
1225	12	65	P20d	CP



HB4 Starlight +30%

Article	V	W	Base	Packaging
1206	12	55	P22d	CP



HB4 StarBlue 4200K

Article	V	W	Base	Packaging
1226	12	55	P22d	CP



H27/1 Starlight +30%

Article	V	W	Base	Packaging
1227	12	27	PG13	CP



H27/2 Starlight +30%

Article	V	W	Base	Packaging
1228	12	27	PGJ13	CP

AUTOMOTIVE SIGNAL BULBS 12V



P21W

Article	V	W	Base	Packaging
1250	12	21	BA15s	CP



P21W

Article	V	W	Base	Packaging
1270	12	21	BAU15s	CP



PY21W Amber

Article	V	W	Base	Packaging
1251	12	21	BAU15s	CP



PY21W Amber

Article	V	W	Base	Packaging
1271	12	21	BA15s	CP



P21/5W

Article	V	W	Base	Packaging
1252	12	21/5	BAY15d	CP



P21/4W

Article	V	W	Base	Packaging
1253	12	21/4	BAZ15d	CP



R5W

Article	V	W	Base	Packaging
1254	12	5	BA15s	CP



R10W

Article	V	W	Base	Packaging
1255	12	10	BA15s	CP



W1,2W

Article	V	W	Base	Packaging
1263	12	1,2	W2x4,6d	CP



W5W

Article	V	W	Base	Packaging
1262	12	5	W2,1x9,5d	CP



WY5W Amber

Article	V	W	Base	Packaging
1264	12	5	W2,1x9,5d	CP



W16W

Article	V	W	Base	Packaging
1265	12	16	W2,1x9,5d	CP



W21W

Article	V	W	Base	Packaging
1266	12	21	W3x16d	CP



W21/5W

Article	V	W	Base	Packaging
1267	12	21/5	W3x16q	CP



WY21W Amber

Article	V	W	Base	Packaging
1268	12	21	WX3x16d	CP



C10W T11x31

Article	V	W	Base	Packaging
1259	12	10	SV8,5	CP



C5W T11x37

Article	V	W	Base	Packaging
1257	12	5	SV8,5	CP



C10W T11x37

Article	V	W	Base	Packaging
1258	12	10	SV8,5	CP



C5W T11x41

Article	V	W	Base	Packaging
1260	12	5	SV8,5	CP



C10W T11x41

Article	V	W	Base	Packaging
1261	12	10	SV8,5	CP



T4W

Article	V	W	Base	Packaging
1256	12	4	BA9s	CP



H6W

Article	V	W	Base	Packaging
1269	12	6	BA9s	CP



18/5W Amber

Article	V	W	Base	Packaging
1273	12	18/5	BAY15d	CP



18/5W

Article	V	W	Base	Packaging
1272	12	18/5	BAY15d	CP

AUTOMOTIVE HEADLIGHT BULBS 24V



H1 Starlight +30%

Article	V	W	Base	Packaging
2401	24	70	P14,5s	CP



H11 Starlight +30%

Article	V	W	Base	Packaging
2411	24	70	PGJ19-2	CP



H3 Starlight +30%

Article	V	W	Base	Packaging
2403	24	70	PK22s	CP



H3 Rally+30%

Article	V	W	Base	Packaging
2413	24	100	PK22s	CP



H4 Starlight +30%

Article	V	W	Base	Packaging
2404	24	75/70	P43t-38	CP



H4 Rally+30%

Article	V	W	Base	Packaging
2414	24	100/90	P43t-38	CP



H7 Starlight +30%

Article	V	W	Base	Packaging
2407	24	70	PX26d	CP



H7 Rally+30%

Article	V	W	Base	Packaging
2417	24	100	PX26d	CP

AUTOMOTIVE SIGNAL BULBS 24V



P21W

Article	V	W	Base	Packaging
2450	24	21	BA15s	CP



P21/5W

Article	V	W	Base	Packaging
2452	24	21/5	BAY15d	CP



R5W

Article	V	W	Base	Packaging
2454	24	5	BA15s	CP



R10W

Article	V	W	Base	Packaging
2455	24	10	BA15s	CP



W1,2W

Article	V	W	Base	Packaging
2463	24	1,2	W2x4,6d	CP



W5W

Article	V	W	Base	Packaging
2462	24	5	W2,1x9,5d	CP



C5W T11x37

Article	V	W	Base	Packaging
2457	24	5	SV8,5	CP



C5W T11x41

Article	V	W	Base	Packaging
2460	24	5	SV8,5	CP



C10W T11x41

Article	V	W	Base	Packaging
2461	24	10	SV8,5	CP



T4W

Article	V	W	Base	Packaging
2456	24	4	BA9s	CP



INSULATION PVC TAPE



Time-tested quality!



art. **IT 110**
 Color: blue
 Length: 10 m
 Width: 19 mm
 Thickness: 0,13 mm
 Temperature: -30°C +70°C
 Tensile strength: 12 MPa
 Barcode: 5005846251109
 Packaging: 300 pcs.



art. **IT 010**
 Color: black
 Length: 10 m
 Width: 19 mm
 Thickness: 0,13 mm
 Temperature: -30°C +70°C
 Tensile strength: 12 MPa
 Barcode: 5005846250102
 Packaging: 300 pcs.



art. **IT 120**
 Color: blue
 Length: 20 m
 Width: 19 mm
 Thickness: 0,13 mm
 Temperature: -30°C +70°C
 Tensile strength: 12 MPa
 Barcode: 5005846251208
 Packaging: 200 pcs.



art. **IT 020**
 Color: black
 Length: 20 m
 Width: 19 mm
 Thickness: 0,13 mm
 Temperature: -30°C +70°C
 Tensile strength: 12 MPa
 Barcode: 5005846250201
 Packaging: 200 pcs.



art. **IT 125**
 Color: blue
 Length: 25 m
 Width: 19 mm
 Thickness: 0,13 mm
 Temperature: -30°C +70°C
 Tensile strength: 12 MPa
 Barcode: 5005846251253
 Packaging: 200 pcs.



art. **IT 025**
 Color: black
 Length: 25 m
 Width: 19 mm
 Thickness: 0,13 mm
 Temperature: -30°C +70°C
 Tensile strength: 12 MPa
 Barcode: 5005846250256
 Packaging: 200 pcs.



art. **IT 130**
 Color: blue
 Length: 30 m
 Width: 19 mm
 Thickness: 0,13 mm
 Temperature: -30°C +70°C
 Tensile strength: 12 MPa
 Штрих-код: 5005846251307
 Packaging: 200 pcs.



art. **IT 030**
 Color: black
 Length: 30 m
 Width: 19 mm
 Thickness: 0,13 mm
 Temperature: -30°C +70°C
 Tensile strength: 12 MPa
 Barcode: 5005846250300
 Packaging: 200 pcs.

PE

DOUBLE SIDED FOAM TAPE

Adhesive: acrylic solvent based
 Tack: outer ≥25#
 inner ≥17#
 180° tear strength: outer ≥15,442N/in
 inner ≥21,128N/in
 80°C holding power: ≥24 hours
 Service temperature: -10°C +80°C
 Thickness: 1mm
 Color: black
 Density: 67 kg/m³



Double Sided PE tape is used for strong fastening of various objects and materials (including mirrors, moldings) to various types of surfaces (including auto works). The tape consists of a new material - foaming polyethylene, which has exceptional characteristics of tear and puncture resistance. Due to a strong base and non-drying adhesive layer, the connection acquires special strength properties.

Article	Size	Barcode
DS 1062	2m x 6mm	5005848810625
DS 1082	2m x 8mm	5005848810823
DS 1102	2m x 10mm	5005848811028
DS 1122	2m x 12mm	5005848811226
DS 1152	2m x 15mm	5005848811523
DS 1202	2m x 20mm	5005848812025
DS 1252	2m x 25mm	5005848812520
DS 1302	2m x 30mm	5005848813022
DS 1402	2m x 40mm	5005848814029
DS 1502	2m x 50mm	5005848815026
DS 1065	5m x 6mm	5005848810656
DS 1085	5m x 8mm	5005848810854
DS 1105	5m x 10mm	5005848811059
DS 1125	5m x 12mm	5005848811257
DS 1155	5m x 15mm	5005848811554
DS 1205	5m x 20mm	5005848812056
DS 1255	5m x 25mm	5005848812551
DS 1305	5m x 30mm	5005848813053
DS 1405	5m x 40mm	5005848814050
DS 1505	5m x 50mm	5005848815057

EVA

DOUBLE SIDED FOAM TAPE

Adhesive: acrylic solvent based
 Tack: outer ≥22#
 inner ≥22#
 180° tear strength: outer ≥0,979N/in
 inner ≥0,993N/in
 80°C holding power: ≥24 hours
 Service temperature: -10°C +80°C
 Thickness: 1mm
 Color: white
 Density: 44 kg/m³



Double Sided EVA tape on foaming polyethylene base has a wide range of using: construction, installation and auto works for reliable fastening of skirting boards and plastic curbs, installation and connection of metal and plastic constructions. In the production of promotional materials and decor for gluing pictures, tables, decorative elements. Due to thick base and specialized gluing layer of the tape, it has high level of adhesion. The tape has increased softness and flexibility (in comparison with similar ones), provides fast and easy connection of various materials. The tape fills all unevennesses, thereby increasing the area and the quality of the clutch. Double Sided EVA tape on foaming polyethylene base is used on rough, uneven surface.

Article	Size	Barcode
DS 2062	2m x 6mm	5005848820624
DS 2082	2m x 8mm	5005848820822
DS 2102	2m x 10mm	5005848821027
DS 2122	2m x 12mm	5005848821225
DS 2152	2m x 15mm	5005848821522
DS 2202	2m x 20mm	5005848822024
DS 2252	2m x 25mm	5005848822529
DS 2302	2m x 30mm	5005848823021
DS 2402	2m x 40mm	5005848824028
DS 2502	2m x 50mm	5005848825025
DS 2065	5m x 6mm	5005848820655
DS 2085	5m x 8mm	5005848820853
DS 2105	5m x 10mm	5005848821058
DS 2125	5m x 12mm	5005848821256
DS 2155	5m x 15mm	5005848821553
DS 2205	5m x 20mm	5005848822055
DS 2255	5m x 25mm	5005848822550
DS 2305	5m x 30mm	5005848823052
DS 2405	5m x 40mm	5005848824059
DS 2505	5m x 50mm	5005848825056

ACRYLIC

DOUBLE SIDED ADHESIVE STRIP

Adhesive: acrylic solvent based
 Tack: <9#
 180° tear strength: >42N/in
 Holding power: >24 hours
 Service temperature: -10°C +150°C
 Thickness: 0,8mm
 Color: gray
 Density: 120 kg/m³



Very High Bonding Tape consists of a durable acrylic adhesive with viscoelastic properties. This provides an extraordinarily strong double sided foam tape that adheres to a broad range of substrates, including aluminum, stainless steel, galvanized steel, composites, plastics, acrylic, polycarbonate, ABS and painted or sealed wood and concrete. Our bonding tapes provide excellent shear strength, conformability, surface adhesion and temperature resistance. They are commonly used in applications across a variety of markets including transportation, appliance, electronics, construction, sign and display and general industrial. Reliably bonds a variety of materials with strength and speed for permanent applications.

Article	Size	Barcode
DS 3062	2m x 6mm	5005848830623
DS 3092	2m x 9mm	5005848830920
DS 3122	2m x 12mm	5005848831224
DS 3152	2m x 15mm	5005848831521
DS 3202	2m x 20mm	5005848832023
DS 3252	2m x 25mm	5005848832528
DS 3302	2m x 30mm	5005848833020
DS 3402	2m x 40mm	5005848834027
DS 3065	5m x 6mm	5005848830654
DS 3095	5m x 9mm	5005848830951
DS 3125	5m x 12mm	5005848831255
DS 3155	5m x 15mm	5005848831552
DS 3205	5m x 20mm	5005848832054
DS 3255	5m x 25mm	5005848832559
DS 3305	5m x 30mm	5005848833051
DS 3405	5m x 40mm	5005848834058

ACRYLIC

DOUBLE SIDED ADHESIVE TAPE

Adhesive: acrylic solvent based
 Tack: <9#
 180° tear strength: >42N/in
 Holding power: >24 hours
 Service temperature: -10°C +150°C
 Thickness: 0,8mm
 Color: transparent
 Density: 150 kg/m³



Very High Bonding Tape consists of a durable acrylic adhesive with viscoelastic properties. This provides an extraordinarily strong double sided foam tape that adheres to a broad range of substrates, including aluminum, stainless steel, galvanized steel, composites, plastics, acrylic, polycarbonate, ABS and painted or sealed wood and concrete. Our bonding tapes provide excellent shear strength, conformability, surface adhesion and temperature resistance. They are commonly used in applications across a variety of markets including transportation, appliance, electronics, construction, sign and display and general industrial. Reliably bonds a variety of materials with strength and speed for permanent applications.

Article	Size	Barcode
DS 4062	2m x 6mm	5005848840622
DS 4092	2m x 9mm	5005848840929
DS 4122	2m x 12mm	5005848841223
DS 4152	2m x 15mm	5005848841520
DS 4202	2m x 20mm	5005848842022
DS 4252	2m x 25mm	5005848842527
DS 4302	2m x 30mm	5005848843029
DS 4402	2m x 40mm	5005848844026
DS 4065	5m x 6mm	5005848840653
DS 4095	5m x 9mm	5005848840950
DS 4125	5m x 12mm	5005848841254
DS 4155	5m x 15mm	5005848841551
DS 4205	5m x 20mm	5005848842053
DS 4255	5m x 25mm	5005848842558
DS 4305	5m x 30mm	5005848843050
DS 4405	5m x 40mm	5005848844057



SETS OF HIGH QUALITY AUTOMOTIVE FUSES

art. **AF 310**

Barcode: 5005846213107
Packaging: 500 pcs.



art. **AF 311**

Barcode: 5005846213114
Packaging: 500 pcs.



art. **AF 312**

Barcode: 5005846213121
Packaging: 500 pcs.



art. **AF 320**

Barcode: 5005846213206
Packaging: 500 pcs.



art. **AF 321**

Barcode: 5005846213213
Packaging: 500 pcs.

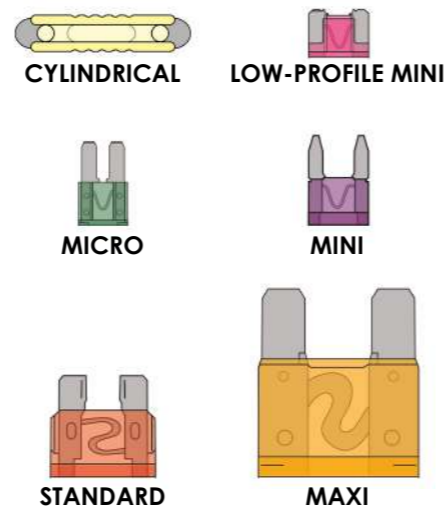
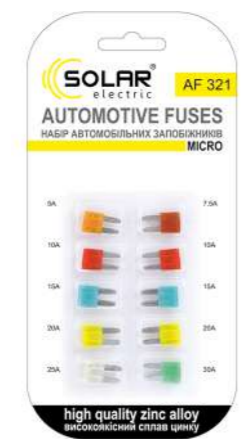

SETS OF AUTOMOTIVE FUSES **STANDARD**

art. **AF 313**



Barcode: 5005846213138
Packaging: 100 pcs.

art. **AF 314**



Barcode: 5005846213145
Packaging: 100 pcs.

art. **AF 315**



Barcode: 5005846213152
Packaging: 100 pcs.

art. **AF 316**



Barcode: 5005846213169
Packaging: 100 pcs.

art. **AF 317**



Barcode: 5005846213176
Packaging: 100 pcs.

art. **AF 318**



Barcode: 5005846213183
Packaging: 100 pcs.



SET OF MIX **STANDARD** AUTOMOTIVE FUSES



art. **AF 319** 180pcs.

5A - 10pcs. 20A - 20pcs.
7,5A - 10pcs. 25A - 20pcs.
10A - 50pcs. 30A - 10pcs.
15A - 50pcs. 35A - 10pcs.

extractor - 2pcs. Barcode: 5005846213190
Packaging: 50 pcs.

SETS OF AUTOMOTIVE FUSES **MAXI**

art. **AF 323**



Barcode: 5005846213237
Packaging: 100 pcs.



art. **AF 324**



Barcode: 5005846213244
Packaging: 100 pcs.



art. **AF 325**



Barcode: 5005846213251
Packaging: 100 pcs.



art. **AF 330**



Barcode: 5005846213305
Packaging: 100 pcs.



BREVIA

Automotive lighting

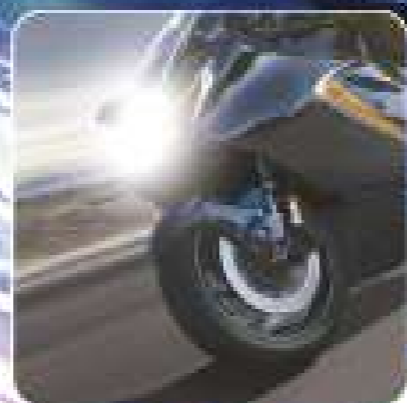

BREVIA®

XENON LAMPS

XENON LAMPS



MORE LIGHT, MORE SAFETY

Brevia XENON HID Lamp - is an excellent choice for all drivers who value maximum visibility and safety. They produce more light than standard lamps, and therefore allow you to illuminate the road surface much better. For drivers this Tool even more safety, as it gives them more time to react. Xenon light is not just the highest achievement of automotive specialists, but also stylish lighting for drivers who want to make their car stand out.

Electric arc technology provides two times brighter light compared to conventional filament technology and at the same time consumes three times less energy. The absence of filaments in xenon bulbs makes them insensitive to road vibration and shocks. Good road lighting is one of the important factors of comfortable and safe driving, thanks to which long night trips will become less tiring. With an average resource of up to 3000 hours, these lamps last longer than halogen lamps, which reduces maintenance and replacement costs.

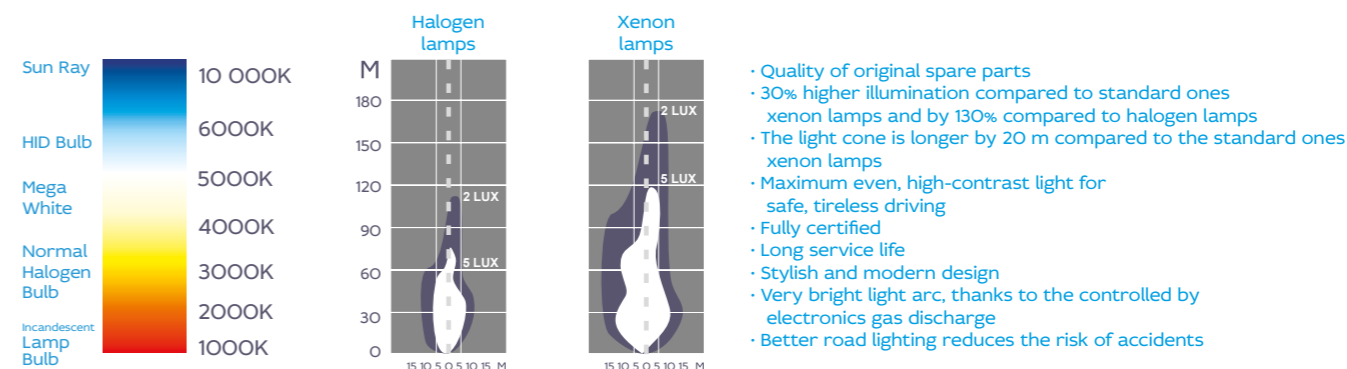

Made in Korea

CAR LAMPS

Brevia xenon lamps are recommended to be replaced by specialists who have the appropriate qualifications.



**XENON LAMPS
MAX POWER +50%**



BREVIA MAX POWER +50% xenon car lamps of the new generation have saturated white light that more brightly and evenly illuminates the road. Xenon lamps BREVIA MAX POWER +50% of the new generation are equipped with BREVIA MAX POWER technology, which ensures high quality lighting. An extended beam of light and up to 50% better visibility - new generation BREVIA MAX POWER +50% xenon lamps allow you to notice obstacles earlier and react in advance. Thanks to the improved illumination of the roadside, you will notice a potential danger earlier. These lamps brightly illuminate every turn, bump in the road, are suitable for the most difficult road conditions and will please even the most demanding drivers.

Lighting is the most important condition for safe driving. Improving the quality of lighting helps prevent emergency situations.

D Series Xenon HID +50%

To replace factory xenon lamps

D1S +50%

Article	V	W	Base	Color temperature
85114MP	85	35	PK32d-2	4300K
85115MP	85	35	PK32d-2	5500K
85116MP	85	35	PK32d-2	6000K

D1R +50%

Article	V	W	Base	Color temperature
85124MP	85	35	PK32d-3	4300K
85125MP	85	35	PK32d-3	5500K
85126MP	85	35	PK32d-3	6000K

D2S +50%

Article	V	W	Base	Color temperature
85214MP	85	35	P32d-2	4300K
85215MP	85	35	P32d-2	5500K
85216MP	85	35	P32d-2	6000K

D2R +50%

Article	V	W	Base	Color temperature
85224MP	85	35	P32d-3	4300K
85225MP	85	35	P32d-3	5500K
85226MP	85	35	P32d-3	6000K

D3S +50%

Article	V	W	Base	Color temperature
85314MP	85	35	PK32d-5	4300K
85315MP	85	35	PK32d-5	5500K
85316MP	85	35	PK32d-5	6000K

D3R +50%

Article	V	W	Base	Color temperature
85324MP	85	35	PK32d-6	4300K
85325MP	85	35	PK32d-6	5500K
85326MP	85	35	PK32d-6	6000K

D4S +50%

Article	V	W	Base	Color temperature
85414MP	85	35	P32d-6	4300K
85415MP	85	35	P32d-6	5500K
85416MP	85	35	P32d-6	6000K

D4R +50%

Article	V	W	Base	Color temperature
85424MP	85	35	P32d-6	4300K
85425MP	85	35	P32d-6	5500K
85426MP	85	35	P32d-6	6000K

H Series Xenon HID +50%

To replace halogen lamps

H1 +50%

Article	V	W	Base	Color temperature
12143MP	85	35	P14,5s	4300K
12150MP	85	35	P14,5s	5500K
12160MP	85	35	P14,5s	6000K

H3 +50%

Article	V	W	Base	Color temperature
12343MP	85	35	PK22S	4300K
12350MP	85	35	PK22S	5500K
12360MP	85	35	PK22S	6000K

H4 Bi-Xenon +50%

Article	V	W	Base	Color temperature
12443MP	85	35	P43t-38	4300K
12450MP	85	35	P43t-38	5500K
12460MP	85	35	P43t-38	6000K

H7 +50%

Article	V	W	Base	Color temperature
12743MP	85	35	PX26d	4300K
12750MP	85	35	PX26d	5500K
12760MP	85	35	PX26d	6000K

HB9006 +50%

Article	V	W	Base	Color temperature
12643MP	85	35	P22d	4300K
12650MP	85	35	P22d	5500K
12660MP	85	35	P22d	6000K

H11 +50%

Article	V	W	Base	Color temperature
12943MP	85	35	PGJ19-2	4300K
12950MP	85	35	PGJ19-2	5500K
12960MP	85	35	PGJ19-2	6000K



XENON LAMPS SET

Brevia xenon lamp sets are manufactured using modern technologies and with high quality control during the production process. The ignition units have processor control and are equipped with a system for bypassing lamp malfunction diagnostics (Super Slim Canbus), are not afraid of temperature changes, and also have a high level of sealing.

The best price/quality option!
Complete set for installation.

Possibility of installation on a car with 12V on-board power supply.

- Power: 35 W
- Available temperature range: 4300K/5000K/6000K
- Base: H1, H3, H4, H7, H8, H11, 9005, 9006, H27/2
- BREVIA ELECTRONIC HID BALLAST SYSTEM ignition units: Super Slim, Super Slim Canbus

Complete set:

- 2 ballasts,
- 2 xenon lamps,
- assembly set,
- instructions



H1

Article	V	W	Ballast	Color temperature
14142	85	35	Super Slim	4300K
14152	85	35	Super Slim	5000K
14162	85	35	Super Slim	6000K
14143	85	35	Super Slim Canbus	4300K
14153	85	35	Super Slim Canbus	5000K
14163	85	35	Super Slim Canbus	6000K

H4

Article	V	W	Ballast	Color temperature
14442	85	35	Super Slim	4300K
14452	85	35	Super Slim	5000K
14462	85	35	Super Slim	6000K
14443	85	35	Super Slim Canbus	4300K
14453	85	35	Super Slim Canbus	5000K
14463	85	35	Super Slim Canbus	6000K

H8

Article	V	W	Ballast	Color temperature
14842	85	35	Super Slim	4300K
14852	85	35	Super Slim	5000K
14862	85	35	Super Slim	6000K
14843	85	35	Super Slim Canbus	4300K
14853	85	35	Super Slim Canbus	5000K
14863	85	35	Super Slim Canbus	6000K

H27

Article	V	W	Ballast	Color temperature
14242	85	35	Super Slim	4300K
14252	85	35	Super Slim	5000K
14262	85	35	Super Slim	6000K
14243	85	35	Super Slim Canbus	4300K
14253	85	35	Super Slim Canbus	5000K
14263	85	35	Super Slim Canbus	6000K

HB9006

Article	V	W	Ballast	Color temperature
14642	85	35	Super Slim	4300K
14652	85	35	Super Slim	5000K
14662	85	35	Super Slim	6000K
14643	85	35	Super Slim Canbus	4300K
14653	85	35	Super Slim Canbus	5000K
14663	85	35	Super Slim Canbus	6000K

H3

Article	V	W	Ballast	Color temperature
14342	85	35	Super Slim	4300K
14352	85	35	Super Slim	5000K
14362	85	35	Super Slim	6000K
14343	85	35	Super Slim Canbus	4300K
14353	85	35	Super Slim Canbus	5000K
14363	85	35	Super Slim Canbus	6000K

H7

Article	V	W	Ballast	Color temperature
14742	85	35	Super Slim	4300K
14752	85	35	Super Slim	5000K
14762	85	35	Super Slim	6000K
14743	85	35	Super Slim Canbus	4300K
14753	85	35	Super Slim Canbus	5000K
14763	85	35	Super Slim Canbus	6000K

H11

Article	V	W	Ballast	Color temperature
14942	85	35	Super Slim	4300K
14952	85	35	Super Slim	5000K
14962	85	35	Super Slim	6000K
14943	85	35	Super Slim Canbus	4300K
14953	85	35	Super Slim Canbus	5000K
14963	85	35	Super Slim Canbus	6000K

HB9005

Article	V	W	Ballast	Color temperature
14542	85	35	Super Slim	4300K
14552	85	35	Super Slim	5000K
14562	85	35	Super Slim	6000K
14543	85	35	Super Slim Canbus	4300K
14553	85	35	Super Slim Canbus	5000K
14563	85	35	Super Slim Canbus	6000K



HALOGEN LAMPS 12V

Brevia Automotive Lighting is a leading manufacturer of automotive lighting, applies innovative technologies using high-quality materials and manufactures the best products. Brevia products meet the highest quality standards, which is why it is the main partner of the world's leading car manufacturers. The line of Brevia 12V car lamps is a family of lighting solutions designed for all consumers.

POWER +30%	POWER ULTRA +60%	MAX POWER +100%	WHITE POWER +60%	POWER BLUE 4200K	RALLY
up to 15m +30%	up to 25m +60%	up to 35m +100%	up to 25m +60%		2X O/E
AVAILABLE:	AVAILABLE:	AVAILABLE:	AVAILABLE:	AVAILABLE:	AVAILABLE:
H1 H3 H4 H7 H8 H9 H10 H11 H15 HB3 HB4 H27/1 H27/2 H16 HIR2	H1 H3 H4 H7	H1 H3 H4 H7	H1 H3 H4 H7	H1 H3 H4 H7 H11 HB3 HB4	H1 H3 H4 H7



H1 Power +30%

Article	V	W	Base
1201OPC	12	55	P14,5s



H1 Power +60%

Article	V	W	Base
1201OPUC	12	55	P14,5s
1201OPUS	12	55	P14,5s



H1 Max Power +100%

Article	V	W	Base
1201OMP	12	55	P14,5s
1201OMPS	12	55	P14,5s



H1 White Power +60%

Article	V	W	Base
1201OPWC	12	55	P14,5s
1201OPWS	12	55	P14,5s



H1 Power Blue 4200K

Article	V	W	Base
1201OPBC	12	55	P14,5s
1201OPBS	12	55	P14,5s



H1 Rally

Article	V	W	Base
1201ORC	12	80	P14,5s



H4 Power +30%

Article	V	W	Base
1204OPC	12	60/80	P43t-38



H3 Power +30%

Article	V	W	Base
1203OPC	12	55	PK22s



H3 Power +60%

Article	V	W	Base
1203OPUC	12	55	PK22s
1203OPUS	12	55	PK22s



H3 Max Power +100%

Article	V	W	Base
1203OMP	12	55	PK22s
1203OMPS	12	55	PK22s



H3 White Power +60%

Article	V	W	Base
1203OPWC	12	55	PK22s
1203OPWS	12	55	PK22s



H3 Power Blue 4200K

Article	V	W	Base
1203OPBC	12	55	PK22s
1203OPBS	12	55	PK22s



H3 Rally

Article	V	W	Base
1203ORC	12	80	PK22s



H7 Power +30%

Article	V	W	Base
1207OPC	12	55	PX26d



H4 Power +60%

Article	V	W	Base
1204OPUC	12	60/55	P43t-38
1204OPUS	12	60/55	P43t-38



H4 Max Power +100%

Article	V	W	Base
1204OMPC	12	60/55	P43t-38
1204OMPS	12	60/55	P43t-38



H4 White Power +60%

Article	V	W	Base
1204OPWC	12	60/55	P43t-38
1204OPWS	12	60/55	P43t-38



H4 Power Blue 4200K

Article	V	W	Base
1204OPBC	12	60/55	P43t-38
1204OPBS	12	60/55	P43t-38



H4 Rally

Article	V	W	Base
1204ORC	12	100/90	P43t-38



H8 Power +30%

Article	V	W	Base
1208OPC	12	35	PGJ19-1



H10 Power +30%

Article	V	W	Base
1205OPC	12	45	PY20d



H7 Power +60%

Article	V	W	Base
1207OPUC	12	55	PX26d
1207OPUS	12	55	PX26d



H7 Max Power +100%

Article	V	W	Base
1207OMPC	12	55	PX26d
1207OMPS	12	55	PX26d



H7 White Power +60%

Article	V	W	Base
1207OPWC	12	55	PX26d
1207OPWS	12	55	PX26d



H7 Power Blue 4200K

Article	V	W	Base
1207OPBC	12	55	PX26d
1207OPBS	12	55	PX26d



H7 Rally

Article	V	W	Base
1207ORC	12	100	PX26d



H9 Power +30%

Article	V	W	Base
1209OPC	12	65	PGJ19-5



H13 Power +30%

Article	V	W	Base
12013PC	12	60/55	P26,4t



H11 Power +30%

Article	V	W	Base
12011PC	12	55	PGJ19-2



H11 Power Blue 4200K

Article	V	W	Base
12011PBC	12	55	PGJ19-2



H16 Power +30%

Article	V	W	Base
12016PC	12	19	PGJ19-3



HB1 Power +30%

Article	Параметри	Base
12101PC	12V 65/45W	P29t



HB3 Power +30%

Article	V	W	Base
12103PC	12	65	P20d



HB3 Power Blue

Article	V	W	Base
12103PBC	12	65	P20d



H27/1 Power +30%

Article	V	W	Base
12271PC	12	27	PG13



H15 Power +30%

Article	V	W	Base
12015PC	12	15/55	PGJ23t-1



H15 Power Blue 4200K

Article	V	W	Base
12015PBC	12	15/55	PGJ23t-1



HIR2 9012 Power +30%

Article	V	W	Base
12012PC	12	55	PX22d



HB5 Power +30%

Article	V	W	Base
12105PC	12	65/55	PX29t



HB4 Power +30%

Article	V	W	Base
12104PC	12	55	P22d



HB4 Power Blue

Article	V	W	Base
12104PBC	12	55	P22d



H27/2 Power +30%

Article	V	W	Base
12272PC	12	27	PGJ13

SIGNAL LAMPS



P21W

Article	V	W	Base
12301C	12	21	BA15s
12301B2	12	21	BA15s



P21/5W

Article	V	W	Base
12303C	12	21/5	BAY15d
12303B2	12	21/5	BAY15d



PY21W AMBER

Article	V	W	Base
12302C	12	21	BAU15s
12302B2	12	21	BAU15s



P21/4W

Article	V	W	Base
12304C	12	21/4	BAZ15d
12304B2	12	21/4	BAZ15d



PR21W Red

Article	V	W	Base
12326C	12	21	BAW15s
12326B2	12	21	BAW15s



PR21/5W Red

Article	V	W	Base
12327C	12	21/5	BAW15d
12327B2	12	21/5	BAW15d

REAR PARKING LIGHTS



R5W

Article	V	W	Base
12305C	12	5	BA15s
12305B2	12	5	BA15s



R10W

Article	V	W	Base
12306C	12	10	BA15s
12306B2	12	10	BA15s

WEDGE BASE LAMPS



W1,2W

Article	V	W	Base
12325C	12	1,2	W2x4,6d
12325B2	12	1,2	W2x4,6d



W3W

Article	V	W	Base
12307C	12	3	W2,1x9,5d
12307B2	12	3	W2,1x9,5d



W5W Power Blue

Article	V	W	Base
12328C			W2,1x9,5d
12328B2			W2,1x9,5d



W5W

Article	V	W	Base
12308C	12	5	W2,1x9,5d
12308B2	12	5	W2,1x9,5d



WY5W AMBER

Article	V	W	Base
12309C	12	5	W2,1x9,5d
12309B2	12	5	W2,1x9,5d



W16W

Article	V	W	Base
12333C	12	16	W2,1x9,5d
12333B2	12	16	W2,1x9,5d

W21W



Article	V	W	Base
12310C	12	21	W3x16d
12310B2	12	21	W3x16d



WY21W AMBER

Article	V	W	Base
12312C	12	21	WX3x16d
12312B2	12	21	WX3x16d

USA TYPE LAMPS



P27W (3156)

Article	V	W	Base
12338B2	12	27	W2.5x16d



P27/7W (3157)

Article	V	W	Base
12339B2	12	12/7	W2.5x16q



P27/7W (3157) AMBER

Article	V	W	Base
12340B2	12	27/7	W2.5x16q

FESTOON LAMPS



C10W T11x31

Article	V	W	Base
12313C	12	10	SV8,5
12313B2	12	10	SV8,5



C10W T11x37

Article	V	W	Base
12315C	12	10	SV8,5
12315B2	12	10	SV8,5



C10W T11x41

Article	V	W	Base
12317C	12	10	SV8,5
12317B2	12	10	SV8,5



C5W T11x37

Article	V	W	Base
12314C	12	5	SV8,5
12314B2	12	5	SV8,5



C5W T11x41

Article	V	W	Base
12316C	12	5	SV8,5
12316B2	12	5	SV8,5



C18W T15x44

Article	V	W	Base
12318C	12	18	SV8,5
12318B2	12	18	SV8,5

ADDITIONAL LAMPS



T4W Power Blue

Article	V	W	Base
12330C	12	4	BA9s



T4W

Article	V	W	Base
12319C	12	4	BA9s



H6W Power Blue

Article	V	W	Base
12331C	12	6	BAX9s



H6W

Article	V	W	Base
12332C	12	6	BAX9s



H21W

Article	V	W	Base
12329B2	12	21	BAY9s



HY21W AMBER

Article	V	W	Base
12330C	12	21	BAW9s
12330B2	12	21	BAW9s

BAX LAMPS



BAX B8,4d Light Blue

Article	V	W	Base
12320C	12	1,2	B8,4d



BAX B8,5d Black

Article	V	W	Base
12321C	12	1,2	B8,5d



BAX B8,3d Black

Article	V	W	Base
12322C	12	1,2	B8,3d



BAX BX8,5d Light Blue

Article	V	W	Base
12323C	12	1,2	BX8,5d



BAX BX8,4d Black

Article	V	W	Base
12324C	12	1,2	BX8,4d



BAX B8,4d Orange

Article	V	W	Base
12334C	12	1,1	B8,4d



BAX B8,4d Beige

Article	V	W	Base
12335C	12	1,5	B8,4d



BAX B8,5d Green

Article	V	W	Base
12336C	12	2	B8,5d



BAX B8,4d Light Green

Article	V	W	Base
12337C	12	2	BX8,4d

PSX SIGNAL LAMPS



P13W

Article	V	W	Base
12213C	12	13	PG18,5d-1



PCY16W AMBER

Article	V	W	Base
12216C	12	16	PU20d/2



PW16W

Article	V	W	Base
12217C	12	16	WP3,3X14,5/8



PS19W

Article	V	W	Base
12219C	12	19	PG20/1



PSY19W AMBER

Article	V	W	Base
12220C	12	19	PG20/2



PW24W

Article	V	W	Base
12227C	12	24	WP3,3X14,5/3



PSX26W

Article	V	W	Base
12230C	12	26	PG18,5d/3



PY24W AMBER

Article	V	W	Base
12229C	12	24	PGU20/4



PS24W

Article	V	W	Base
12224C	12	24	PG20/3



PSX24W

Article	V	W	Base
12225C	12	24	PG20/7



PSY24W AMBER

Article	V	W	Base
12226C	12	24	PG20/4



PWY24W AMBER

Article	V	W	Base
12228C	12	24	WP3,3X14,5/3



 Low beam, high beam, additional high beam lamp



 Front turn signals



 Interior lighting



 Side turn signals



 Front parking lights



 Front fog lights



 Dashboard lighting



 Reverse light



 Additional stop signal



 Glove compartment lights



 Rear parking lights



 Stop signal



 Rear turn signals



 Trunk lighting



 Illumination of the license plate



 Rear fog lights



Brevia lamps for buses, trucks and special equipment with a supply voltage of 24V have high performance and reliability.

The new **Power Duty** i **Master Rally** 24V lamps create maximum safety and comfort while driving, and also differ in economy, long service life and high resistance to vibrations.

We produce powerful and reliable 24V lamps for any needs of large and small fleets, logistics companies and professional drivers.

POWER
DUTY



VIBRATION RESISTANT

up to
15 m

STANDARD



AVAILABLE

H1 H3 H4
H7 H11

MASTER
RALLY



2X VIBRATION RESISTANT

STANDARD



AVAILABLE

H1 H3 H4
H7



Lamps for headlights with a voltage of 24V are designed for high loads and vibrations to which trucks and other heavy machinery are prone. Bad roads and vibration are common causes of headlight bulb failure. More rigid fastening of the plinth to protect against mechanical damage. Strong thread in the form of a double spiral, designed for resistance to vibrations in a wide range of frequencies while maintaining stable characteristics.



H1 H3 H4 H7 H11



H1 H3 H4 H7 H11

 Low beam, high beam, additional high beam lamp

 Front fog lights

 Dashboard lighting

 Interior lighting

 Front turn signals

 Rear parking lights

 License plate lights

 W3W W5W W1,2W BAX

 W3W W5W T4W R5W

 R5W R10W W5W

 P21W PY21W

 R5W R10W C5W W5W P21/5W P21W

 P21W

 P21W





H1 Power Duty

Article	V	W	Base
2401OPDC	24	70	P14,5s



H1 Master Rally

Article	V	W	Base
2401OMRC	24	100	P14,5s



H3 Power Duty

Article	V	W	Base
2403OPDC	24	70	PK22s



H3 Master Rally

Article	V	W	Base
2403OMRC	24	100	PK22s



H4 Power Duty

Article	V	W	Base
2404OPDC	24	75/70	P43t-38



H4 Master Rally

Article	V	W	Base
2404OMRC	24	100/90	P43t-38



H7 Power Duty

Article	V	W	Base
2407OPDC	24	70	PX26d



H7 Master Rally

Article	V	W	Base
2407OMRC	24	100	PX26d



H11 Power Duty

Article	V	W	Base
24011PDC	24	70	PGJ19-2



H11 Master Rally

Article	V	W	Base
24011MRC	24	100	PGJ19-2

SIGNAL LAMPS



P21W

Article	Параметри	Base
24301C	24V 21W	BA15s



P21W/5W

Article	V	W	Base
24303C	24	21/5	BAY15d



PY21W AMBER

Article	Параметри	Base
24302C	24V 21W	BAU15s

REAR PARKING LIGHTS



R5W

Article	V	W	Base
24305C	24	5	BA15s



R10W

Article	V	W	Base
24306C	24	10	BA15s

WEDGE BASE LAMPS



W1,2W

Article	V	W	Base
24325C	24	1,2	W2x4,6d



W3W

Article	V	W	Base
24307C	24	3	W2,1x9,5d



W5W

Article	V	W	Base
24308C	24	5	W2,1x9,5d

FESTOON LAMPS



C5W T11x37

Article	V	W	Base
24314C	24	5	SV 8,5



C5W T11x41

Article	V	W	Base
24316C	24	5	SV8,5



C10W T11x41

Article	V	W	Base
24317C	24	10	SV 8,5

ADDITIONAL LAMPS



T4W

Article	V	W	Base
24319C	24	4	BA9s

BAX LAMPS



BAX B8,5d Grey

Article	V	W	Base
24321C	24	1,2	B8,5d



BAX B8,3d Grey

Article	V	W	Base
24322C	24	1,2	B8,3d

BREVIA

LED technology

LED SIGNAL LAMPS



CANbus
NON-POLAR

POWER

PERFORMANCE

CANbus
NON-POLAR

≈ P21W BA15s
12/24V

☀ White 6000K

330 LUMENS

6 × 3020 SMD LEDS



6 SMD LEDS 3020
CHIPS OF HIGH BRIGHTNESS
OF THE NEW GENERATION

- High brightness thanks to a special design
- The aircraft aluminum body efficiently dissipates heat
- Energy-saving and long-lasting
- Easy and simple installation

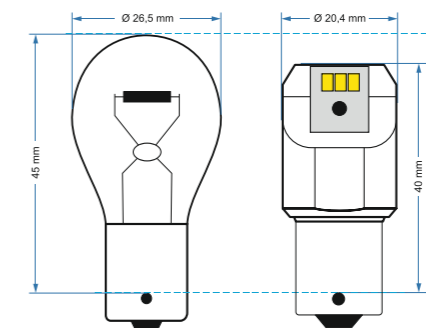

2 pcs

≈ W5W POWER

Article	Voltage	LED	Brightness	Base
10108X2	12/24V	4x1616SMD	150Lm	W2,1x9,5d

≈ W16W POWER

Article	Voltage	LED	Brightness	Base
10133X2	12/24V	4x3020SMD	210Lm	W2,1x9,5d

≈ P21W POWER

Article	Voltage	LED	Brightness	Base
10101X2	12/24V	6x3020SMD	330Lm	BA15s

≈ P21/5W POWER

Article	Voltage	LED	Brightness	Base
10103X2	12/24V	6x3020SMD	330Lm	BAY15d

≈ W21W POWER

Article	Voltage	LED	Brightness	Base
10110X2	12/24V	6x3020SMD	330Lm	W3x16d

≈ W21/5W POWER

Article	Voltage	LED	Brightness	Base
10111X2	12/24V	6x3020SMD	330Lm	W3x16q

≈ P27W (3156) POWER

Article	Voltage	LED	Brightness	Base
10138X2	12/24V	6x3020SMD	330Lm	W2,5x16d

≈ P27/7W (3157) POWER

Article	Voltage	LED	Brightness	Base
10139X2	12/24V	6x3020SMD	330Lm	W2,5x16q



More Bright, More Styling



CANbus
NON-POLAR

≈ P21W BA15s

12/24V

☀ White 6000K

330 LUMENS

15 × 2835 SMD LEDS



15 SMD LEDS 2835
CHIPS OF HIGH BRIGHTNESS
OF THE NEW GENERATION

- The ideal shape repeats the standard signal lamp
- The high-quality transparent overlay perfectly diffuses light and protects the chips from damage
- Super high brightness 360°

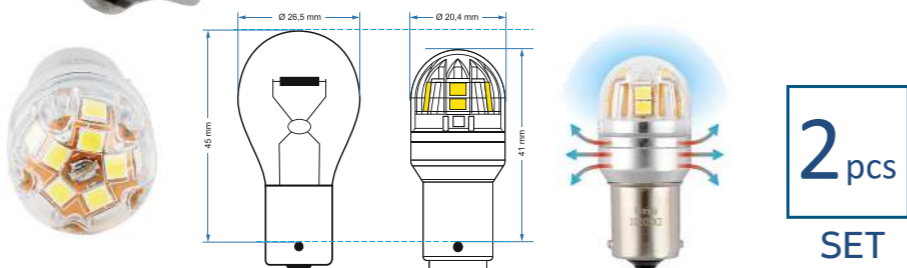

≈ W5W S POWER

Article	Voltage	LED	Brightness	Base
10208X2	12/24V	5x2835SMD	150Lm	W2,1x9,5d

≈ P21/5W S POWER

Article	Voltage	LED	Brightness	Base
10203X2	12/24V	15x2835SMD	330Lm	BAY15d

≈ T4W S POWER

Article	Voltage	LED	Brightness	Base
10219X2	12/24V	5x2835SMD	150Lm	BA9s

≈ W21W S POWER

Article	Voltage	LED	Brightness	Base
10210X2	12/24V	15x2835SMD	330Lm	W3x16d

≈ C5W, C10W S POWER

Article	Voltage	LED	Brightness	Base
10214X2	12V	4x2835SMD	180Lm	T11x36MM

≈ W21/5W S POWER

Article	Voltage	LED	Brightness	Base
10211X2	12/24V	15x2835SMD	330Lm	W3x16q

≈ W16W S POWER

Article	Voltage	LED	Brightness	Base
10233X2	12/24V	5x2835SMD	210Lm	W2,1x9,5d

≈ P27W (3156) S POWER

Article	Voltage	LED	Brightness	Base
10238X2	12/24V	15x2835SMD	330Lm	W2,5x16d

≈ P21W S POWER

Article	Voltage	LED	Brightness	Base
10201X2	12/24V	15x2835SMD	330Lm	BA15s

≈ P27/7W (3157) S POWER

Article	Voltage	LED	Brightness	Base
10239X2	12/24V	15x2835SMD	330Lm	W2,5x16q



CANbus
NON-POLAR

≈ P21W BA15s

12/24V

☀ White 6000K

330 LUMENS

14 × 2835 SMD LEDS



14 SMD LEDS 2835
CHIPS OF HIGH BRIGHTNESS
OF THE NEW GENERATION

- HD lens expands and enlarges the beam of light
- Maximum brightness 360°
- High-performance heat-dissipating radiator

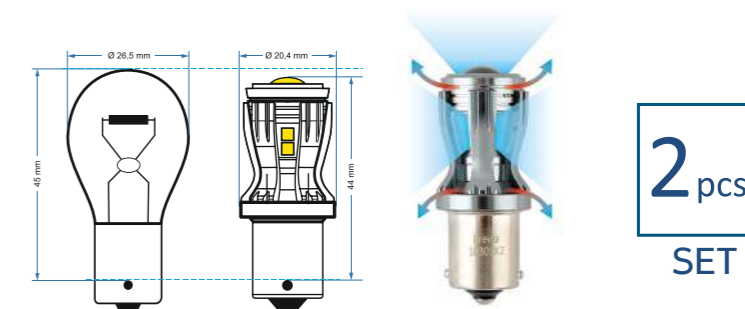

≈ P21W POWER PRO

Article	Voltage	LED	Brightness	Base
10301X2	12/24V	15x2835SMD	330Lm	BA15s

≈ W21/5W POWER PRO

Article	Voltage	LED	Brightness	Base
10311X2	12/24V	14x2835SMD	350Lm	W3x16q

≈ P21/5W POWER PRO

Article	Voltage	LED	Brightness	Base
10303X2	12/24V	14x2835SMD	350Lm	BAY15d

≈ P27W (3156) POWER PRO

Article	Voltage	LED	Brightness	Base
10338X2	12/24V	14x2835SMD	350Lm	W2,5x16d

≈ W21W POWER PRO

Article	Voltage	LED	Brightness	Base
10310X2	12/24V	14x2835SMD	350Lm	W3x16d

≈ P27/7W (3157) POWER PRO

Article	Voltage	LED	Brightness	Base
10339X2	12/24V	14x2835SMD	350Lm	W2,5x16q

BREVIA

Working light

LED INSPECTION LAMP

PROFESSIONAL



1. Power button (switching modes: 500/1000lm).
2. Powerful 10W inspection light.
3. USB output 5V/2A (Power bank function).
4. Battery charge level indicator.
5. Charging input Type-C (5V/2A).
6. Multi angle positioning.
7. High strength magnet (2pcs).

Compatible with Art.: 11520.

Art.:11510 LED INSPECTION LAMP

1000 LUMENS
LED 10W POWER

Working Time up to 6h
Li-Ion Battery 4000 mAh
Protection IP54
Magnet

LED	10W COB
BRIGHTNESS	1000LM
BATTERY	Li-Ion 4000 mAh
WORKING TIME	up to 6 h
CHARGING TIME	up to 3 h
CHARGING PORT	USB Type-C
PROTECTION	IP54 IK09
FIXING	2 magnets
PACKAGING	carton box
Q-TY IN BOX	8
BARCODE	8802306115103

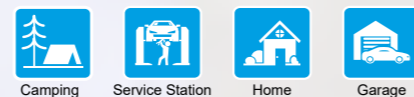

BREVIA®

LED INSPECTION LAMP

UNDER BONNET INSPECTION LAMP

2x1000 LUMENS
LED POWER 2x10W
LENGTH **120cm**

Working Time up to 6h

Li-Ion Battery 4000 mAh

Protection IP54

Magnet

Art.:11520

LED	2 x 10W COB
BRIGHTNESS	2 x 1000 LM
BATTERY	Li-Ion 2 x 4000 mAh
WORKING TIME	up to 6 h
CHARGING TIME	up to 3 h
CHARGING PORT	USB Type-C
PROTECTION	IP54 IK09
FIXING	extendable arms / 2 magnets
PACKAGING	carton box
Q-TY IN BOX	4
BARCODE	8802306115202



1. Power button (switching modes: 500/1000lm).
2. Powerful 2x10W inspection light.
3. USB output 5V/2A (Power bank function).
4. Battery charge level indicator.
5. Charging input Type-C (5V/2A).
6. Multi angle positioning.
7. High strength magnet (2pcs).
8. Extendable arms (1200 – 1900cm).



Multi purpose use. Ideal for workshops, caravanning, camping or general household and emergency lighting. Suitable for art. 115100.



Camping



Service Station



Home



Garage



SEE BETTER, WORK BETTER

UNDER BONNET INSPECTION LAMP



- Working Time
- Li-Ion Battery
- Protection
- Magnet



1. Powerful 40SMD inspection light.
2. High strength magnet (2x2pcs).
3. Multi angle positioning.
4. Power button (switching modes:500/1000lm).
5. Hook for mounting the lamp.
6. Extendable arms (1200 – 1900cm).
7. Charging input USB (5V/2A).

- Camping
- Service Station
- Home
- Garage

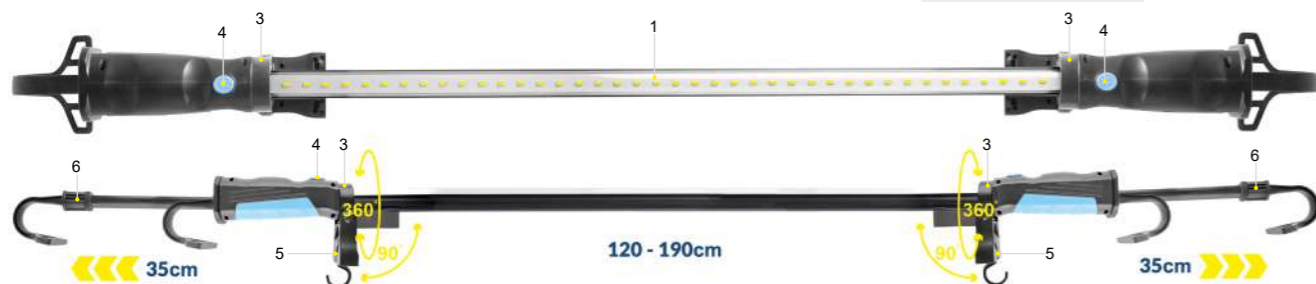

Art.:11430

1000 LUMENS SMD LEDs 40 LENGTH 120cm

LED	40 SMD
BRIGHTNESS	1000 LM
BATTERY	4000 mAh
WORKING TIME	up to 4 h
CHARGING TIME	up to 3 h
CHARGING PORT	mirco USB
PROTECTION	IP20 IK05
FIXING	extendable arms / 4 magnets / 2 hook
PACKAGING	carton box
Q-TY IN BOX	4
BARCODE	8802306114304

LED WORK LIGHT + AIR COMPRESSOR



1800 LUMENS

LED 18W POWER

FLASH LIGHT 1W + 3W RED WARNING LIGHT

100W AIR COMPRESSOR

8 BAR

Max pressure

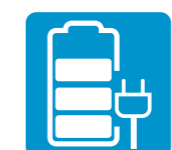

Rechargeable

Art.:11450

LED	18W COB
BRIGHTNESS	1800LM
BATTERY	11.1V 2600 mAh, 28.86 Wh
WORKING TIME	Inspection light : 3h / 7h Warning light - 9h Flash light - 10h
COMPRESSOR POWER	100 W.
MAX PRESSURE	8 Bar
CAPACITY	20 l/min.
CHARGING TIME	3,5 h (5V 3A adapter is recommended)
CHARGING CONNECTOR	USB TYPE-C
PACKAGING	carton box
Q-TY IN BOX	4
BARCODE	8802306114502

UNDER BONNET INSPECTION LAMP

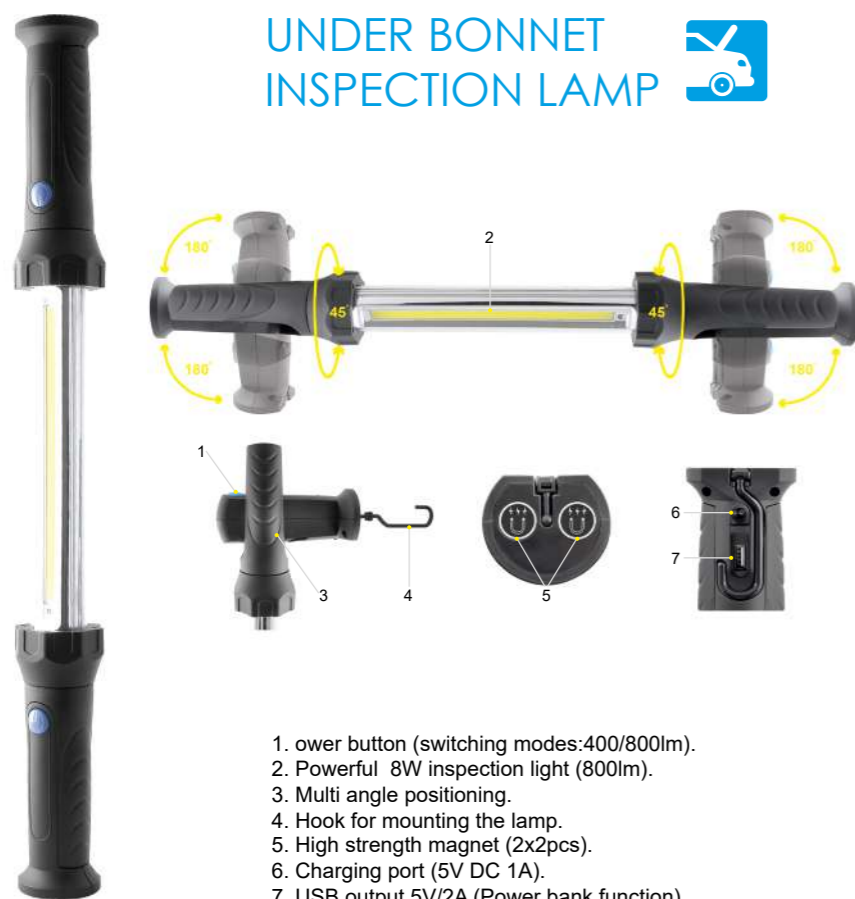

1. Power button (switching modes:400/800lm).
2. Powerful 8W inspection light (800lm).
3. Multi angle positioning.
4. Hook for mounting the lamp.
5. High strength magnet (2x2pcs).
6. Charging port (5V DC 1A).
7. USB output 5V/2A (Power bank function)

Art.:11420

800 LUMENS LED POWER 8W LENGTH 60cm

- Working Time
- Li-Ion Battery
- Protection
- Magnet

LED	8W COB
BRIGHTNESS	800LM
BATTERY	Li-Ion 2200 mAh
WORKING TIME	up to 5 h
CHARGING TIME	up to 3 h
CHARGING PORT	USB
PROTECTION	IP20 IK05
FIXING	4 magnets / 2 hooks
PACKAGING	carton box
Q-TY IN BOX	20
BARCODE	8802306114205

- Camping
- Service Station
- Home
- Garage



1. Powerful 18W inspection light.
2. Red warning light 3W .
3. Flash light 1W (120lm).
4. Hook for mounting the lamp .
5. Compressor control display with backlight .
6. Unit: PSI-KPA-BAR-KG/CM².
7. Power button (switching modes: 800/1800lm; warning light: glow/ flashing); flash light 1W (120lm).
8. Battery charge level indicator.
9. Charging input Type-C (5V/3A).
10. USB output 5V/2A (Power bank function).
11. Power connector DC 12V for the air compressor (adapter included).
12. Screw connection for nipple.
13. Screw connection for compressor hose.

- DC 12V Adapter
- Working Time
- USB Type-C
- Power Bank
- Capacity
- AUTO STOP Function



1. Powerful 10W inspection light (1000lm).
2. High strength magnet (2pcs).
3. Multi angle positioning.
4. Power button (switching modes: 500/750/1000lm).
5. Charging input Type-C (5V/2A).
6. USB output 5V/2A (Power bank function).
7. Battery charge level indicator.
8. Fixing hole.

LED INSPECTION LAMP
Art.:11410

300 LUMENS
LED 3W POWER
+ FLASH LIGHT 1W

up to 6h Working Time
4400 mAh Li-Ion Battery
IP54 Protection
Magnet

LED	10W COB
BRIGHTNESS	1000LM
BATTERY	Li-Ion 4400 mAh
WORKING TIME	up to 6 h
CHARGING TIME	up to 3 h
CHARGING PORT	USB Type-C
PROTECTION	IP54 IK09
FIXING	2 magnets
PACKAGING	carton box
Q-TY IN BOX	20
BARCODE	8802306114106



LED INSPECTION LAMP
Art.:11350

300 LUMENS
LED 3W POWER
+ FLASH LIGHT 1W

up to 3h Working Time
2000 mAh Li-Ion Battery
IP20 Protection
Magnet

LED	3W COB + 1W
BRIGHTNESS	300LM
BATTERY	Li-Ion 2000 mAh
WORKING TIME	up to 3 h
CHARGING TIME	up to 3 h
CHARGING PORT	micro USB
PROTECTION	IP20 IK07
FIXING	magnets / hook
PACKAGING	carton box
Q-TY IN BOX	20
BARCODE	8802306113505



LED INSPECTION LAMP
Art.:11360

300 LUMENS
LED 3W POWER
+ FLASH LIGHT 1W

up to 3h Working Time
2000 mAh Li-Ion Battery
IP20 Protection
Magnet

LED	3W COB + 1W
BRIGHTNESS	300LM
BATTERY	Li-Ion 2000 mAh
WORKING TIME	up to 3 h
CHARGING TIME	up to 3 h
CHARGING PORT	micro USB
PROTECTION	IP20 IK05
FIXING	magnet / hook
PACKAGING	carton box
Q-TY IN BOX	20
BARCODE	8802306113604



1. Multi angle positioning.
2. Rubber protection ring.
3. Charging input USB (5V/2A).
4. Power button (switching modes: 350/650lm/emergency signal).
5. Hold power button.
6. Hand rope with emergency whistle.
7. Powerful 10W inspection light (650lm).

LED INSPECTION LAMP
Art.:11600

650 LUMENS
LED 10W POWER
LIGHT RANGE 500M

up to 4h Working Time
4400 mAh Li-Ion Battery
IP67 Protection
Magnet

LED	10W
BRIGHTNESS	650LM
BATTERY	4400 mAh
WORKING TIME	up to 4 h
CHARGING TIME	up to 4 h
CHARGING PORT	micro USB
PROTECTION	IP67 IK09
PACKAGING	carton box
Q-TY IN BOX	10
BARCODE	8802306116001



LED INSPECTION LAMP
Art.:11370

400 LUMENS
24 SMD LEDS
TWIN LAMP 40cm

up to 3h Working Time
2000 mAh Li-Ion Battery
IP20 Protection
Magnet

LED	24SMD
BRIGHTNESS	400LM
BATTERY	Li-Ion 2000 mAh
WORKING TIME	up to 3 h
CHARGING TIME	up to 3 h
CHARGING PORT	micro USB
PROTECTION	IP20 IK05
FIXING	magnets / hook
PACKAGING	carton box
Q-TY IN BOX	20
BARCODE	8802306113703

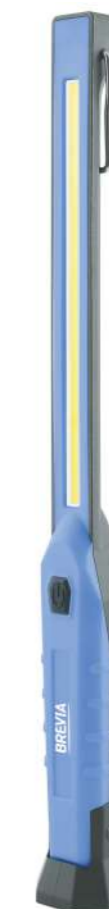

LED INSPECTION LAMP
Art.:11380

300 LUMENS
LED 3W POWER
+ FLASH LIGHT 1W

up to 5h Working Time
2000 mAh Li-Ion Battery
IP20 Protection
Magnet

LED	3W+1W
BRIGHTNESS	300LM + 120LM
BATTERY	Li-Ion 2000 mAh
WORKING TIME	up to 5 h
CHARGING TIME	up to 3 h
CHARGING PORT	micro USB
PROTECTION	IP20 IK05
FIXING	magnets
PACKAGING	blister
Q-TY IN BOX	20
BARCODE	8802306113802





LED INSPECTION LAMP
Art.:11310

150 LUMENS
5 SMD LEDS + 1W FLASH LIGHT

Working Time: up to 10h
Battery: AA x 3
Protection: IP20
Magnet

LED	8SMD + 1W
BRIGHTNESS	300LM
BATTERY	3xAAA
WORKING TIME	up to 10 h
PROTECTION	IP20 IK05
FIXING	2 magnets / hook
PACKAGING	carton box
Q-TY IN BOX	20
BARCODE	8802306113109



LED INSPECTION LAMP
Art.:11320

300 LUMENS
LED 3W POWER + FLASH LIGHT 1W

Working Time: up to 3h
Battery: 2000 mAh Li-Ion
Protection: IP20
Magnet

LED	3W COB + 1W
BRIGHTNESS	300LM
BATTERY	Li-Ion 2000 mAh
WORKING TIME	up to 3 h
CHARGING TIME	up to 3 h
CHARGING PORT	micro USB
PROTECTION	IP20 IK05
FIXING	2 magnets / hook
PACKAGING	blister
Q-TY IN BOX	20
BARCODE	8802306113208



LED INSPECTION LAMP
Art.:11440

300 LUMENS
LED 3W POWER + FLASH LIGHT 1W

Working Time: up to 10h
Battery: AA x 3
Protection: IP20
Magnet

LED	3W COW + 1W
BRIGHTNESS	300LM
BATTERY	3xAA
WORKING TIME	up to 10 h
PROTECTION	IP20 IK05
FIXING	magnet
PACKAGING	carton box
Q-TY IN BOX	20
BARCODE	8802306114403



LED INSPECTION LAMP
Art.:11390

150 LUMENS
LED 2W POWER

Working Time: up to 10h
Battery: AAA x 3
Protection: IP20
Magnet

LED	2W COB
BRIGHTNESS	150LM
BATTERY	3xAAA
WORKING TIME	up to 10 h
PROTECTION	IP20 IK05
FIXING	magnet
PACKAGING	blister
Q-TY IN BOX	24
BARCODE	8802306113901



LED INSPECTION LAMP
Art.:11340

300 LUMENS
LED 3W POWER + FLASH LIGHT 1W

Working Time: up to 3h
Battery: 2000 mAh Li-Ion
Protection: IP20
Magnet

LED	3W COB+1W
BRIGHTNESS	300LM
BATTERY	Li-Ion 2000 mAh
WORKING TIME	up to 3 h
CHARGING TIME	up to 3 h
CHARGING PORT	micro USB
PROTECTION	IP20 IK05
FIXING	magnet / hook
PACKAGING	carton box
Q-TY IN BOX	20
BARCODE	8802306113406



LED INSPECTION LAMP
Art.:11330

300 LUMENS
LED 3W POWER + FLASH LIGHT 1W

Working Time: up to 3h
Battery: 2000 mAh Li-Ion
Protection: IP20
Magnet

LED	3W COB+1W
BRIGHTNESS	300LM
BATTERY	Li-Ion 2000 mAh
WORKING TIME	up to 3 h
CHARGING TIME	up to 3 h
CHARGING PORT	AC 220B
PROTECTION	IP20 IK05
FIXING	magnet / hook
PACKAGING	carton box
Q-TY IN BOX	20
BARCODE	8802306113307



LED INSPECTION LAMP
Art.:11210

150 LUMENS
6 SMD LEDS + 1W FLASH LIGHT

Working Time: up to 3h
Battery: 900 mAh Li-Ion
Protection: IP20
Magnet

LED	6SMD + 1W
BRIGHTNESS	150LM
BATTERY	Li-Ion 900 mAh
WORKING TIME	up to 3 h
CHARGING TIME	up to 1,5 h
CHARGING PORT	micro USB
PROTECTION	IP20 IK05
FIXING	magnet
PACKAGING	blister
Q-TY IN BOX	20
BARCODE	8802306112102



LED INSPECTION LAMP
Art.:11220

150 LUMENS
LED 2W POWER + FLASH LIGHT 1W

Working Time: up to 3h
Battery: 900 mAh Li-Ion
Protection: IP20
Magnet

LED	2W COB + 1W
BRIGHTNESS	150LM
BATTERY	Li-Ion 900 mAh
WORKING TIME	up to 3 h
CHARGING TIME	up to 1,5 h
CHARGING PORT	micro USB
PROTECTION	IP20 IK05
FIXING	magnet
PACKAGING	blister
Q-TY IN BOX	20
BARCODE	8802306112201



BREVIA

Working light

CHOOSE INSPECTION LAMP!



ARTICLE	11390	11210	11220	11310	14440	11320	11330	11340	11350	11360	11380	11370	11410	11510	11420	11430	11520	11600	ARTICLE
LED	2W COB	6SMD + 1W	2W COB + 1W	8SMD + 1W	3W COB + 1W	3W COB + 1W	3W COB + 1W	3W COB + 1W	3W COB + 1W	3W COB + 1W	2W + 1W	24SMD	10W COB	10W COB	8W COB	40 SMD	2 x 10W COB	10W	LED
BRIGHTNESS	150lm	150lm	150lm	300lm	300lm	300lm	300lm	300lm	300lm	300lm	300lm	400lm	1000lm	1000lm	800lm	1000lm	2 x 1000lm	650lm	BRIGHTNESS
BATTERY	3xAAA	Li-Ion 900mAh	Li-Ion 900mAh	3xAA	3xAA	Li-Ion 2000mAh	Li-Ion 2000mAh	Li-Ion 2000mAh	Li-Ion 2000mAh	Li-Ion 2000mAh	Li-Ion 2000mAh	Li-Ion 2000mAh	Li-Ion 4400mAh	Li-Ion 4000mAh	Li-Ion 2200mAh	Li-Ion 4000mAh	Li-Ion 2 x 4000mAh	Li-Ion 4400mAh	BATTERY
WORKING TIME	up to 10 h		up to 3 h	up to 10 h	up to 10 h	up to 3 h	up to 3 h	up to 3 h	up to 3 h	up to 3 h	up to 5 h	up to 3 h	up to 6 h	up to 6 h	up to 5 h	up to 4 h	up to 6 h	up to 4 h	WORKING TIME
CHARGING TIME	—	up to 1,5 h	up to 1,5 h	—	—	up to 3 h	up to 3 h	up to 3 h	up to 3 h	up to 3 h	up to 3 h	up to 3 h	up to 3 h	up to 3 h	up to 3 h	up to 3 h	до 3 год	up to 4 h	CHARGING TIME
CHARGING PORT	—	micro USB	micro USB	—	—	micro USB	micro USB	micro USB	micro USB	micro USB	micro USB	micro USB	USB Type-C	USB Type-C	USB	micro USB	USB Type-C	micro USB	CHARGING PORT
PROTECTION	IP20 IK05	IP20 IK05	IP20 IK05	IP20 IK05	IP20 IK05	IP20 IK05	IP20 IK05	IP20 IK05	IP20 IK07	IP20 IK05	IP20 IK05	IP20 IK05	IP54 IK09	IP54 IK09	IP20 IK05	IP20 IK05	IP54 IK09	IP67 IK09	PROTECTION
ADDITIONAL FUNCTIONS	—	—	—	Multi angle positioning	Multi angle positioning		8 LED Camping Light	—	—	—	—	—	Power Bank	Power Bank Compatible with 11520	Power Bank	—	Power Bank	emergency signal, whistle	ADDITIONAL FUNCTIONS
FIXING	magnet	magnet	magnet	2 magnets hook	2 magnets hook	2 magnets hook	magnet hook	magnet hook	magnet hook	magnet hook	magnet	magnet hook	magnets	magnets	4 magnets 2 hooks	Extendable arms 4 magnets 2 hooks	Extendable arms 2 magnets	—	FIXING
PACKAGING	blister	blister	blister	carton box	carton box	blister	carton box	carton box	carton box	carton box	blister	carton box	carton box	carton box	carton box	carton box	carton box	carton box	PACKAGING
Q-TY IN BOX	24	20	20	20	20	20	20	20	20	20	20	20	20	8	20	4	4	10	Q-TY IN BOX

ALLIGATOR®

Your reliable assistant in emergency situations!



ALLIGATOR®

BATTERY CHARGER & STARTER

art. AC 811

Heavy duty professional battery charger & starter

Input voltage : AC 220-240 V
 Output voltage : DC 12/24 V
 Output charging power : 2200 W
 Output starting power : 12000 W
 Charging current : 60/70 A
 Max charging current : 100 A
 Battery capacity : 1000 Ah
 Starting current : 480 A
 Barcode : 5005846208110
 Packaging : 1 pc.



For cars, motorcycles and other vehicles

- Charge indicator
- Recharge protection
- Protection against short circuit

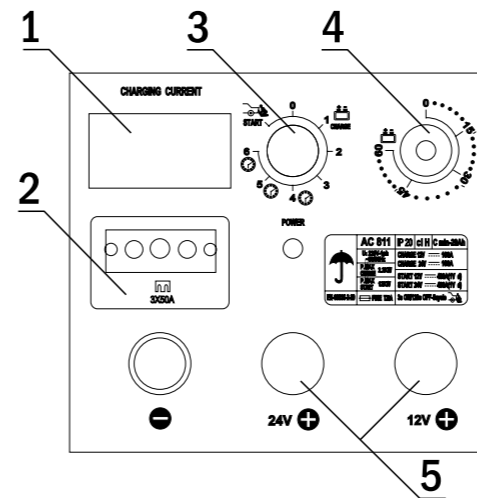

1. Ammeter;
2. Fuse;
3. Multi-functional current switch;
4. Timer;
5. Clamps 12 or 24V

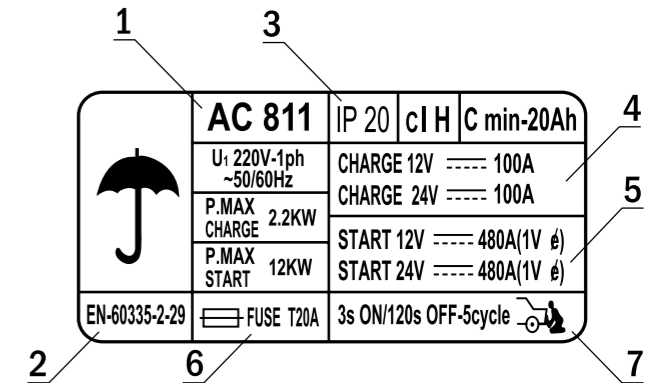

1. Article;
2. Euro standard;
3. Class of protection;
4. Charge specification;
5. Startup specification;
6. Network specification;
7. Starter modes.



art. AC 812

Smart battery charger

Input voltage : AC 220-240 V
 Output voltage : DC 6/12 V
 Max charge voltage : 15 V
 Max current : 4 A
 Battery capacity: 120 Ah
 Power cable : 1,7 m
 Charging cable : 1,4 m
 Barcode : 5005846208127
 Packaging : 20 pcs.

- Charge indicator
- Recharge protection
- Over temperature protection
- Short Circuit Protection



1,2-120 Ah For cars, motorcycles and other vehicles

1 - Voltage at the terminals of the battery.
 2 - Battery charging process.

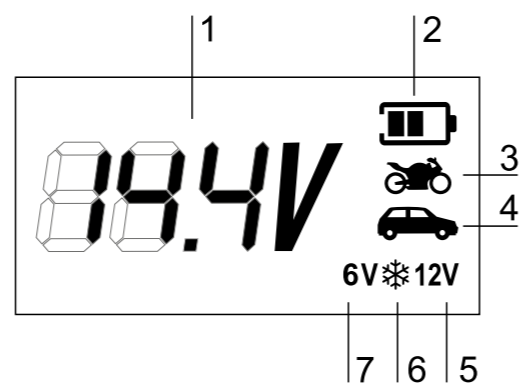

- 6V **Mode 1** : Voltage 6V, current 2A (icon 3 and 7 on the display)
- 6V * **Mode 2** : Voltage 6V, current 2A, strong frost (icon 3, 6, 7 on the display)
- 12V **Mode 3** : Voltage 12V, current 2A (icon 3 and 5 on the display)
- 12V * **Mode 4** : Voltage 12V, current 2A, strong frost (icon 3, 6, 5 on the display)
- 12V **Mode 5** : Voltage 12V, current 4A (icon 4 and 5 on the display)
- 12V * **Mode 6** : Voltage 12V, current 4A, strong frost (icon 4, 6, 5 on the display)

art. AC 802

Battery Charger for charging lead-acid batteries

Input voltage : AC 220-240 V
 Output voltage : DC 6/12 V
 Max current : 6 A
 Battery capacity : 15-80 Ah
 Power cable : 1,7 m
 Charging cable : 1,4 m
 Indicator scale : +
 Barcode : 5005846208028
 Packaging : 10 pcs.



art. AC 803

Battery Charger for charging lead-acid batteries

Input voltage : AC 220-240 V
 Output voltage : DC 12 V
 Max current : 6 A
 Battery capacity : 20-80 Ah
 Power cable : 1,7 m
 Charging cable : 1,4 m
 Indicator scale : +
 Barcode : 5005846208035
 Packaging : 10 pcs.



art. AC 804

Battery Charger for charging lead-acid batteries

Input voltage : AC 220-240 V
 Output voltage : DC 6/12 V
 Max current : 8 A
 Battery capacity : 15-1200 Ah
 Power cable : 1,7 m
 Charging cable : 1,4 m
 Indicator scale : +
 Barcode : 5005846208042
 Packaging : 5 pcs.



art. AC 805

Battery Charger for charging lead-acid batteries

Input voltage : AC 220-240 V
 Output voltage : DC 12 V
 Max charge voltage : 15 V
 Max current : 18 A
 Battery capacity : 120 Ah
 Power cable : 1,1 m
 Charging cable : 1,1 m
 Indicator scale : +
 Barcode : 5005846208059
 Packaging : 8 pcs.



art. AC 806

Battery Charger for charging lead-acid batteries

Input voltage : AC 220-240 V
 Output voltage : DC 12 V
 Max charge voltage : 15 V
 Max current : 18 A
 Battery capacity : 120 Ah
 Power cable : 1,1 m
 Charging cable : 1,1 m
 Indicator scale : +
 Barcode : 5005846208066
 Packaging : 8 pcs.



art. AC 807

Battery charger for lead-acid

Input voltage : AC 220-240 V
 Output voltage : DC 6/12 V
 Max current : 10 A
 Battery capacity : 100 Ah
 Power cable : 1,7 m
 Charging cable : 1,7 m
 Indicator scale : +
 Barcode : 5005846208073
 Packaging : 10 pcs.



WET AGM

art. AC 808

Battery charger for lead-acid

Input voltage : AC 220-240 V
 Output voltage : DC 12/24 V
 Max current : 15 A
 Battery capacity : 150 Ah
 Power cable : 1,7 m
 Charging cable : 1,7 m
 Indicator scale : +
 Barcode : 5005846208080
 Packaging : 10 pcs.



WET AGM



art. AC 809

Battery Charger for charging lead-acid batteries

Input voltage : AC 220-240 V
 Output voltage : DC 12/24 V
 Output charging power : 450 W
 Charging current : 8/12 A
 Max charging current : 20 A
 Power cable : 1,6 m
 Charging wires : 1,5 m
 Indicator scale : +
 Barcode : 5005846208097
 Packaging : 4 pcs.

art. AC 810

Battery Charger for charging lead-acid batteries

Input voltage : AC 220-240 V
 Output voltage : DC 12/24 V
 Output charging power : 950 W
 Output starting power : 6400 W
 Charging current : 20A/30A
 Max charging current : 45 A
 Max battery capacity : 300 Ah
 Starting current : 130 A
 Indicator scale : +
 Barcode : 5005846208103
 Packaging : 2 pcs.



AC 805 AC 806 AC 807 AC 808 AC 809 AC 810 AC 811 AC 812

	AC 805	AC 806	AC 807	AC 808	AC 809	AC 810	AC 811	AC 812
Input voltage	12V	12V	6V/12V	12V/24V	12V/24V	12V/24V	12V/24V	6V/12V
Max charging current	18A	18A	10A	15A	20A	45A	100A	4A
Max battery capacity	120Ah	120Ah	100Ah	150Ah	220Ah	300Ah	1000Ah	120Ah
Current regulation	MANUAL	MANUAL	MANUAL	MANUAL	AUTOMATIC	AUTOMATIC	AUTOMATIC	AUTOMATIC
Charging current	—	—	—	—	—	130A	480A	—
Power cable	1,1M	1,1M	1,7M	1,7M	1,6M	1,6M	1,6M	1,7M
Charging wires	1,1M	1,1M	1,7M	1,7M	1,5M	1,5M	1,5M	1,4M

art. BC 621
Booster cables
200A



Current : 200 A
Length : 2 m
Barcode : 5005846206215
Packaging : 20 pcs.

art. BC 623
Booster cables
200A



Current : 200 A
Length : 2,5 m
Barcode : 5005846206239
Packaging : 20 pcs.

art. BC 622
Booster cables
200A

-40°C frost-resistant material



Current : 200 A
Length : 2,5 m
Barcode : 5005846206222
Packaging : 20 pcs.

art. BC 642
Booster cables
400A

-40°C frost-resistant material



Current : 400 A
Length : 3 m
Barcode : 5005846206420
Packaging : 15 pcs.

art. BC 643
Booster cables
400A

-40°C frost-resistant material



Current : 400 A
Length : 3 m
Barcode : 5005846206437
Packaging : 12 pcs.

art. BC 631
Booster cables
300A



Current : 300 A
Length : 2 m
Barcode : 5005846206314
Packaging : 20 pcs.

art. BC 634
Booster cables
300A



Current : 300 A
Length : 2,5 m
Barcode : 5005846206345
Packaging : 20 pcs.

art. BC 632
Booster cables
300A

-40°C frost-resistant material



Current : 300 A
Length : 2,5 m
Barcode : 5005846206321
Packaging : 12 pcs.

art. BC 653
Booster cables
500A



Current : 500 A
Length : 3 m
Barcode : 5005846206536
Packaging : 15 pcs.

art. BC 651
Booster cables
500A



Current : 500 A
Length : 3 m
Barcode : 5005846206512
Packaging : 10 pcs.

art. BC 652
Booster cables
500A

-40°C frost-resistant material



Current : 500 A
Length : 3,5 m
Barcode : 5005846206529
Packaging : 10 pcs.

art. BC 633
Booster cables
300A

-40°C frost-resistant material



Current : 300 A
Length : 3 m
Barcode : 5005846206338
Packaging : 12 pcs.

art. BC 641
Booster cables
400A

-40°C frost-resistant material



Current : 400 A
Length : 2,5 m
Barcode : 5005846206413
Packaging : 15 pcs.

art. CP 655
Clamps for booster cables
10A



Current : 10 A
Set : 2 pcs.
Barcode : 5005846206550
Packaging : 200 pcs.

art. CP 625
Clamps for booster cables
100-200A



Current : 100-200 A
Set : 2 pcs.
Barcode : 5005846206253
Packaging : 100 pcs.

art. CP 635
Clamps for booster cables
200-300A



Current : 200-300 A
Set : 2 pcs.
Barcode : 5005846206352
Packaging : 100 pcs.

art. CP 645
Clamps for booster cables
300-500A



Current : 300-500 A
Set : 2 pcs.
Barcode : 5005846206451
Packaging : 50 pcs.

CarLife®



CarLife®

HYDRAULIC BOTTLE JACK

art. **BJ402**

HYDRAULIC BOTTLE JACK **2T**



Lifting capacity: 2 т
Lifting height: 148-278 mm
Type of packaging: colour box
Barcode: 5005856204027
Packaging: 10 pcs.

art. **BJ402P**

HYDRAULIC BOTTLE JACK **2T**



Lifting capacity: 2 т
Lifting height: 148-278 mm
Type of packaging: plastic case
Barcode: 5005856214026
Packaging: 5 pcs.

art. **BJ403**

HYDRAULIC BOTTLE JACK **3T**



Lifting capacity: 3 т
Lifting height: 180-340 mm
Type of packaging: colour box
Barcode: 5005856204034
Packaging: 6 pcs.

art. **BJ403P**

HYDRAULIC BOTTLE JACK **3T**



Lifting capacity: 3 т
Lifting height: 180-340 mm
Type of packaging: plastic case
Barcode: 5005856214033
Packaging: 5 pcs.

art. **BJ404**

HYDRAULIC BOTTLE JACK **4T**



Lifting capacity: 4 т
Lifting height: 180-340 mm
Type of packaging: colour box
Barcode: 5005856204041
Packaging: 6 pcs.

art. **BJ404P**

HYDRAULIC BOTTLE JACK **4T**



Lifting capacity: 4 т
Lifting height: 180-340 mm
Type of packaging: plastic case
Barcode: 5005856214040
Packaging: 5 pcs.

art. **BJ405**

HYDRAULIC BOTTLE JACK **5T**



Lifting capacity: 5 t
Lifting height: 195-380 mm
Type of packaging: colour box
Barcode: 5005856204058
Packaging: 6 pcs.

art. **BJ405P**

HYDRAULIC BOTTLE JACK **5T**



Lifting capacity: 5 t
Lifting height: 195-380 mm
Type of packaging: plastic case
Barcode: 5005856214057
Packaging: 5 pcs.

art. **BJ412**

HYDRAULIC BOTTLE JACK **12T**



Lifting capacity: 12 t
Lifting height: 210-395 mm
Type of packaging: colour box
Barcode: 5005856214125
Packaging: 4 pcs.

art. **BJ416**

HYDRAULIC BOTTLE JACK **16T**



Lifting capacity: 16 t
Lifting height: 225-425 mm
Type of packaging: colour box
Barcode: 5005856204164
Packaging: 2 pcs.

art. **BJ406**

HYDRAULIC BOTTLE JACK **6T**



Lifting capacity: 6 t
Lifting height: 200-385 mm
Type of packaging: colour box
Barcode: 5005856204065
Packaging: 6 pcs.

art. **BJ406P**

HYDRAULIC BOTTLE JACK **6T**



Lifting capacity: 6 t
Lifting height: 200-385 mm
Type of packaging: plastic case
Barcode: 5005856214064
Packaging: 5 pcs.

art. **BJ420**

HYDRAULIC BOTTLE JACK **20T**



Lifting capacity: 20 t
Lifting height: 235-440 mm
Type of packaging: colour box
Barcode: 5005856214200
Packaging: 2 pcs.

art. **BJ412S**

HYDRAULIC BOTTLE JACK **12T**
Low profile



Lifting capacity: 12 t
Lifting height: 190-365 mm
Type of packaging: colour box
Barcode: 5005856204126
Packaging: 4 pcs.

art. **BJ408**

HYDRAULIC BOTTLE JACK **8T**



Lifting capacity: 8 t
Lifting height: 200-385 mm
Type of packaging: colour box
Barcode: 5005856204089
Packaging: 4 pcs.

art. **BJ410**

HYDRAULIC BOTTLE JACK **10T**



Lifting capacity: 10 t
Lifting height: 200-385 mm
Type of packaging: colour box
Barcode: 5005856204102
Packaging: 4 pcs.

art. **BJ420S**

HYDRAULIC BOTTLE JACK **20T**
Low profile



Lifting capacity: 20 t
Lifting height: 185-345 mm
Type of packaging: colour box
Barcode: 5005856204201
Packaging: 2 pcs.

art. **BJ432S**

HYDRAULIC BOTTLE JACK **32T**
Low profile



Lifting capacity: 32 t
Lifting height: 225-325 mm
Type of packaging: colour box
Barcode: 5005856204324
Packaging: 2 pcs.

art. **BJ402D**

HYDRAULIC BOTTLE JACK **2T**
Double ram



Lifting capacity: 2 т
Lifting height: 150-360 mm
Type of packaging: colour box
Barcode: 5005856224025
Packaging: 5 pcs.

art. **BJ404D**

HYDRAULIC BOTTLE JACK **4T**
Double ram



Lifting capacity: 4 т
Lifting height: 155-365 mm
Type of packaging: colour box
Barcode: 5005856224049
Packaging: 4 pcs.

art. **FJ575**

HYDRAULIC FLOOR JACK **2T**



Lifting capacity: 2 т
Lifting height: 130-330 mm
Type of packaging: colour box
Barcode: 5005856205758
Packaging: 1 pc.

art. **FJ575P**

HYDRAULIC FLOOR JACK **2T**



Lifting capacity: 2 т
Lifting height: 130-330 mm
Type of packaging: plastic case
Barcode: 5005856215757
Packaging: 1 pc.

art. **FJ560**

HYDRAULIC FLOOR JACK **2T**



Lifting capacity: 2 т
Lifting height: 125-300 mm
Type of packaging: colour box
Barcode: 5005856205604
Packaging: 1 pc.

art. **FJ560P**

HYDRAULIC FLOOR JACK **2T**



Lifting capacity: 2 т
Lifting height: 125-300 mm
Type of packaging: plastic case
Barcode: 5005856215603
Packaging: 1 pc.

art. **FJ590**

HYDRAULIC FLOOR JACK **2T**



Lifting capacity: 2 т
Lifting height: 135-335 mm
Type of packaging: colour box
Barcode: 5005856205901
Packaging: 1 pc.

art. **FJ590P**

HYDRAULIC FLOOR JACK **2T**



Lifting capacity: 2 т
Lifting height: 135-335 mm
Type of packaging: plastic case
Barcode: 5005856215900
Packaging: 1 pc.

art. **FJ565**

HYDRAULIC FLOOR JACK **2T**



Lifting capacity: 2 т
Lifting height: 125-305 mm
Type of packaging: colour box
Barcode: 5005856205659
Packaging: 1 pc.

art. **FJ565P**

HYDRAULIC FLOOR JACK **2T**



Lifting capacity: 2 т
Lifting height: 125-305 mm
Type of packaging: plastic case
Barcode: 5005856215658
Packaging: 1 pc.

art. **FJ610**

HYDRAULIC FLOOR JACK **2T**



Lifting capacity: 2 т
Lifting height: 135-350 mm
Type of packaging: colour box
Barcode: 5005856206106
Packaging: 1 pc.

art. **FJ610P**

HYDRAULIC FLOOR JACK **2T**



Lifting capacity: 2 т
Lifting height: 135-350 mm
Type of packaging: plastic case
Barcode: 5005856216105
Packaging: 1 pc.

art. SJ228

With rubber saddle



SCISSOR JACK

1,2T

Lifting capacity: 1,2 t
Lifting height: 100-350 mm
Barcode: 5005846202286
Packaging: 8 pcs.

art. SJ226

With rubber saddle and ratchet



SCISSOR JACK

1,5T

Lifting capacity: 1,5 t
Lifting height: 104-385 mm
Barcode: 5005846202262
Packaging: 8 pcs.

art. SJ225

With metal saddle



SCISSOR JACK

1,5T

Lifting capacity: 1,5 t
Lifting height: 104-385 mm
Barcode: 5005846202255
Packaging: 8 pcs.

art. SJ222

With rubber saddle



SCISSOR JACK

1,5T

Lifting capacity: 1,5 t
Lifting height: 104-385 mm
Barcode: 5005846202224
Packaging: 8 pcs.

art. SJ224

With metal saddle



SCISSOR JACK

2T

Lifting capacity: 2 t
Lifting height: 120-413 mm
Barcode: 5005846202248
Packaging: 6 pcs.

art. SJ227

With rubber saddle



SCISSOR JACK

2T

Lifting capacity: 2 t
Lifting height: 120-413 mm
Barcode: 5005846202279
Packaging: 6 pcs.



art. TR703

TOW ROPE WITH METAL HOOKS

2,5T

Max. load capacity: 2,5 t
Length: 4 m
Barcode: 5005846207038
Packaging: 30 pcs.



art. TR703P

TOW ROPE WITH METAL HOOKS

2,5T

Max. load capacity: 2,5 t
Length: 4 m
Barcode: 5005846207168
Packaging: 30 pcs.



art. TR708

TOW ROPE WITH METAL HOOKS

3T

Max. load capacity: 3 t
Length: 4 m
Barcode: 5005846217082
Packaging: 30 pcs.



art. TR708P

TOW ROPE WITH METAL HOOKS

3T

Max. load capacity: 3 t
Length: 4 m
Barcode: 5005846217181
Packaging: 30 pcs.



art. TR702

TOW ROPE WITH METAL HOOKS

3T

Max. load capacity: 3 t
Length: 4 m
Barcode: 5005846207021
Packaging: 30 pcs.



art. TR702P

TOW ROPE WITH METAL HOOKS

3T

Max. load capacity: 3 t
Length: 4 m
Barcode: 5005846207151
Packaging: 30 pcs.



art. TR701

TOW ROPE WITH METAL HOOKS

3T

Max. load capacity: 3 t
Length: 4,5 m
Barcode: 5005846207014
Packaging: 30 pcs.



art. TR709

TOW ROPE WITH CARBINES

3T

Max. load capacity: 3 t
Length: 4,5 m
Barcode: 5005846217099
Packaging: 30 pcs.



art. TR706

TOW ROPE WITH METAL HOOKS

3T

Max. load capacity: 3 т
Length: 5 m
Barcode: 5005846207069
Packaging: 30 pcs.



art. TR706P

TOW ROPE WITH METAL HOOKS

3T

Max. load capacity: 3 т
Length: 5,5 m
Barcode: 5005846207106
Packaging: 30 pcs.



art. TR705P

TOW ROPE WITH METAL HOOKS

4,5T

Max. load capacity: 4,5 т
Length: 5 m
Barcode: 5005846207090
Packaging: 20 pcs.



art. TR710P

TOW ROPE WITH METAL HOOKS

5T

Max. load capacity: 5 т
Length: 5 m
Barcode: 5005846217105
Packaging: 20 pcs.



art. TR704P

TOW ROPE WITH METAL HOOKS

6T

Max. load capacity: 6 т
Length: 5,5 m
Barcode: 5005846207083
Packaging: 20 pcs.



art. TR707P

TOW ROPE WITH METAL HOOKS

8T

Max. load capacity: 8 т
Length: 5,5 m
Barcode: 5005846207076
Packaging: 10 pcs.



art. TR705

TOW ROPE WITH METAL HOOKS

4,5T

Max. load capacity: 4,5 т
Length: 5 m
Barcode: 5005846207052
Packaging: 20 pcs.



art. TR704

TOW ROPE WITH METAL HOOKS

6T

Max. load capacity: 6 т
Length: 5,5 m
Barcode: 5005846207045
Packaging: 20 pcs.

art. RD712

RATCHET TIE DOWN OF TWO PARTS

3T

Break strength: 3 т
Width: 46 mm
Length: 6 m
Barcode: 5005846207120
Packaging: 8 pcs.

art. RD713

RATCHET TIE DOWN OF TWO PARTS

3T

Break strength: 3 т
Width: 46 mm
Length: 8 m
Barcode: 5005846207137
Packaging: 8 pcs.

art. RD714

RATCHET TIE DOWN OF TWO PARTS

3T

Break strength: 3 т
Width: 46 mm
Length: 10 m
Barcode: 5005846207144
Packaging: 8 pcs.

art. RD711

RATCHET TIE DOWN OF TWO PARTS



Break strength: 1 т
Width: 25 mm
Length: 5 m
Barcode: 5005846207113
Packaging: 30 pcs.

art. RD718

RATCHET TIE DOWN



Width: 25 mm
Length: 5 m
Barcode: 5005846207182
Packaging: 36 pcs.

art. RD719

RATCHET TIE DOWN WITH HOOKS



Width: 25 mm
Length: 5 m
Barcode: 5005846207199
Packaging: 36 pcs.

art. RD720

RATCHET TIE DOWN WITH QUICK RELEASE



Width: 25 mm
Length: 5 m
Barcode: 5005846207205
Packaging: 72 pcs.

art. RD721

RATCHET TIE DOWN WITH QUICK RELEASE



Width: 25 mm
Length: 2x2,5 m
Barcode: 5005846207212
Packaging: 72 pcs.

art. FP842

DOUBLE CYLINDER FOOT PUMP

Size of cylinder: 2x55x120 mm
 Material of cylinder: metal
 Max. Pressure: 10 Atm
 Hose length: 60 cm
 Barcode: 5005846428426
 Packaging: 10 pcs.



hose made of natural rubber resistant to low temperatures, odorless



high-precision metal pressure gauge



convenient connector

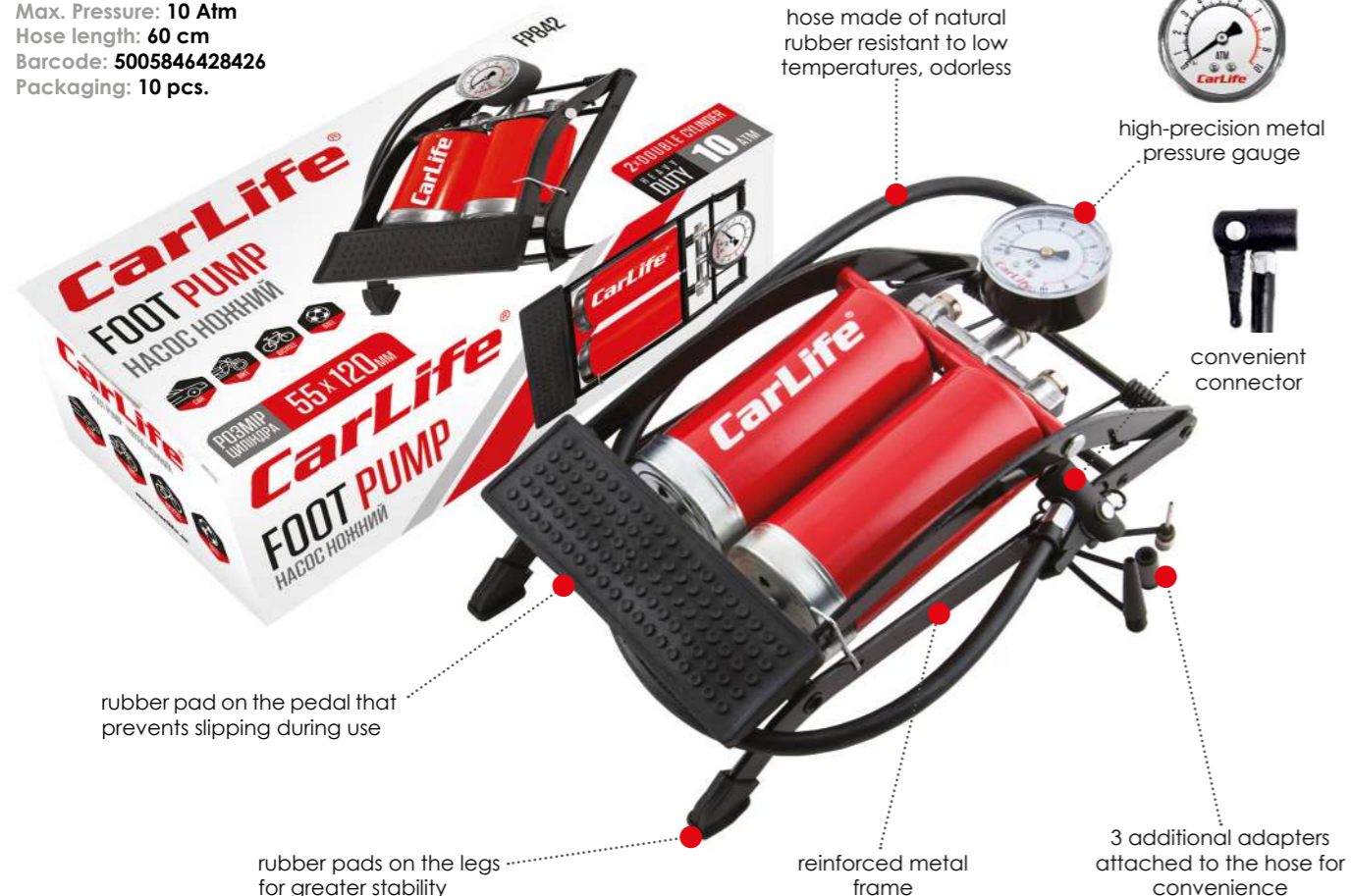

rubber pad on the pedal that prevents slipping during use

rubber pads on the legs for greater stability

reinforced metal frame

3 additional adapters attached to the hose for convenience

art. FP840

FOOT PUMP



Cylinder size: 55x120 mm
 Material of cylinder: metal
 Max. Pressure: 10 Atm
 Hose length: 60 cm
 Barcode: 5005846428402
 Packaging: 25 pcs.

art. FP841

FOOT PUMP



Cylinder size: 80x130 mm
 Material of cylinder: metal
 Max. Pressure: 6 Atm
 Hose length: 60 cm
 Barcode: 5005846428419
 Packaging: 10 pcs.

art. HP821

HAND PUMP

Cylinder size: 38x500 mm
 Material of cylinder: aluminum
 Max. Pressure: 10 Atm
 Hose length: 54 cm
 Barcode: 5005846428211
 Packaging: 10 pcs.



3 additional adapters attached to the hose for convenience

art. HP820

HAND PUMP



Cylinder size: 38x500 mm
 Material of cylinder: metal
 Max. Pressure: 10 Atm
 Hose length: 54 cm
 Barcode: 5005846428204
 Packaging: 10 pcs.

art. HP810

HAND PUMP



Cylinder size: 38x500 mm
 Material of cylinder: metal
 Max. Pressure: 10 Atm
 Hose length: 54 cm
 Barcode: 5005846428105
 Packaging: 10 pcs.

convenient connector

hose made of natural rubber resistant to low temperatures, odorless

high-precision metal pressure gauge

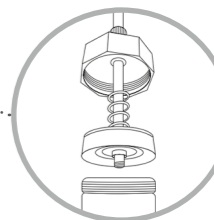

reliable piston made of high-quality materials

aluminum cylinder

folding metal leg



art. HP811

HAND PUMP



Cylinder size: 38x500 mm
 Material of cylinder: aluminum
 Max. Pressure: 10 Atm
 Hose length: 54 cm
 Barcode: 5005846428112
 Packaging: 10 pcs.

art. TG571

TIRE PRESSURE GAUGE

7,5
ATM



Corps: metal
Pressure relief button : +
Barcode: 5005846415716
Packaging: 140 pcs.

art. TG571P

TIRE PRESSURE GAUGE

7,5
ATM



Corps: metal
Plastic case: +
Pressure relief button : +
Barcode: 5005846425715
Packaging: 100 pcs.

art. TG572

TIRE PRESSURE GAUGE

3,5
ATM



Corps: plastic
Pressure relief button : +
Barcode: 5005846415723
Packaging: 200 pcs.

art. TG574

TIRE PRESSURE GAUGE

4
ATM



Corps: metal
with rubber coating
Barcode: 5005846415747
Packaging: 144 pcs.

art. TG573

TIRE PRESSURE GAUGE

5
ATM



Corps: plastic
Barcode: 5005846415730
Packaging: 200 pcs.

art. TG581

TIRE PRESSURE GAUGE

11
ATM



Corps: metal
Barcode: 5005846458119
Packaging: 50 pcs.

art. TG582

TIRE PRESSURE GAUGE

12
ATM



Corps: metal
Barcode: 5005846458218
Packaging: 50 pcs.

art. TG561

DIGITAL TIRE GAUGE



Voltage: 3 V
Display: 21x10 mm
Working temperature:
-20°C to +50°C
Barcode: 5005846415616
Packaging: 100 pcs.

art. TG562

DIGITAL TIRE GAUGE WITH LED BACKLIGHT



Voltage: 3 V
Display: 21x10 mm
Working temperature:
-20°C to +50°C
Barcode: 5005846425623
Packaging: 100 pcs.

art. TG552

PNEUMATIC GUN FOR TIRE INFLATION



Max. Pressure: 16 Bar
Hose length: 370 mm
Corps: metal
Barcode: 5005846415525
Packaging: 50 pcs.

art. TG553

PNEUMATIC GUN FOR TIRE INFLATION



Max. Pressure: 12 Bar
Hose length: 450 mm
Corps: metal
Barcode: 5005846415531
Packaging: 10/20 pcs.

art. TYPE1

MUD FLAPS UNIVERSAL, FRONT 2 pcs.

Barcode: 4820252241626
Packaging: 20 pcs.



-30°C
FROST RESISTANCE



art. TYPE2

MUD FLAPS UNIVERSAL, BACK 2 pcs.

Barcode: 4820252241633
Packaging: 20 pcs.



-30°C
FROST RESISTANCE



art. TUN1

MUD FLAPS UNIVERSAL, FRONT 2 pcs.

Barcode: 4820252241602
Packaging: 20 pcs.



-30°C
FROST RESISTANCE



art. TUN2

MUD FLAPS UNIVERSAL, BACK 2 pcs.

Barcode: 4820252241619
Packaging: 20 pcs.



-30°C
FROST RESISTANCE



art. TR750

TUBELESS TIRE REPAIR KIT

Barcode: 5005846427504
Packaging: 100 pcs.

1. tube with activator glue
2. awl-grater
3. awl with detachable eye
4. special rubber harnesses



art. **WR101**
SPARK PLUG WRENCH



Size: 16 mm
Barcode: 5005846201012
Packaging: 50 pcs.

art. **WR102**
SPARK PLUG WRENCH



Size: 21 mm
Barcode: 5005846201029
Packaging: 50 pcs.

art. **WR121**
SPARK PLUG WRENCH,
WITH PLASTIC HANDLE



Size: 16 mm
Barcode: 5005846201210
Packaging: 50 pcs.

art. **WR122**
SPARK PLUG WRENCH,
WITH PLASTIC HANDLE



Size: 21 mm
Barcode: 5005846201227
Packaging: 50 pcs.

art. **WR151**
CROSS WHEEL WRENCH, PROFESSIONAL, WITH
REINFORCED CENTER (CHROME VANADIUM)



Size: 7 mm x 19 mm x 21 mm x 1/2"
Barcode: 5005846201517
Packaging: 20 pcs.

art. **WR152**
CROSS WHEEL WRENCH, PROFESSIONAL,
WITH REINFORCED CENTER



Size: 17 mm x 19 mm x 21 mm x 1/2"
Barcode: 5005846201524
Packaging: 20 pcs.

art. **WR131**
WHEEL WRENCH, TELESCOPIC
PROFESSIONAL
(CHROME VANADIUM)



Size: 17x19 mm
Barcode: 5005846201319
Packaging: 20 pcs.

art. **WR132**
WHEEL WRENCH,
TELESCOPIC



Size: 17x19 mm
Barcode: 5005846201326
Packaging: 20 pcs.

art. **WR171**
OIL FILTER WRENCH,
WITH CHAIN



Barcode: 5005846201715
Packaging: 50 pcs.

art. **WR172**
OIL FILTER WRENCH,
L-SHAPED



Barcode: 5005846201722
Packaging: 50 pcs.

art. **FC521**
PLASTIC
FUEL CAP



Barcode: 5005846415211
Packaging: 200 pcs.

art. **FC522**
PLASTIC
FUEL CAP



Barcode: 5005846415228
Packaging: 100 pcs.

art. **SD601**
CUSHION GRIP SCREWDRIVER
6 in 1, MAGNETIC



Barcode: 5058464260190
Packaging: 50 pcs.

art. **WR161**
WHEEL WRENCH, L-SHAPED



Size: 17 mm
Barcode: 5005846201616
Packaging: 30 pcs.

art. **WR162**
WHEEL WRENCH, L-SHAPED



Size: 19 mm
Barcode: 5005846201623
Packaging: 30 pcs.

art. **WT101**
EMERGENCY WARNING TRIANGLE



Size: 420x40 mm
Barcode: 5005846411015
Packaging: 50 pcs.

art. **WT101C**
EMERGENCY WARNING TRIANGLE



Size: 420x40 mm
Barcode: 5005846411114
Packaging: 50 pcs.

art. **WT102**
EMERGENCY WARNING TRIANGLE



Size: 420x40 mm
Barcode: 5005846411022
Packaging: 50 pcs.

art. CC901

PVA CLEANING CHAMOIS

Size: 64x43 cm
Barcode: 5005846419011
Packaging: 12/96 pcs.



art. CC902

PVA CLEANING CHAMOIS

Size: 43x32 cm
Barcode: 5005846419028
Packaging: 12/144 pcs.



art. CC903

MICROFIBER CLOTH UNIVERSAL



Size: 40x40 cm
Barcode: 5005846419035
Packaging: 240 pcs.

art. CC923

MICROFIBER CLOTH UNIVERSAL



Size: 40x40 cm
Barcode: 5005846419233
Packaging: 240 pcs.

art. CC933

MICROFIBER CLOTH UNIVERSAL



Size: 40x40 cm
Barcode: 5005846419332
Packaging: 240 pcs.

art. CC908

MICROFIBER CLOTH FOR GLASS



Size: 30x40 cm
Barcode: 5005846419080
Packaging: 240 pcs.

art. CC907

MICROFIBER CLOTH UNIVERSAL



Size: 30x30 cm
Barcode: 5005846419073
Packaging: 240 pcs.

art. CC927

MICROFIBER CLOTH UNIVERSAL



Size: 30x30 cm
Barcode: 5005846419271
Packaging: 240 pcs.

art. CC937

MICROFIBER CLOTH UNIVERSAL



Size: 30x30 cm
Barcode: 5005846419370
Packaging: 240 pcs.

art. CC925

MICROFIBER CLOTH UNIVERSAL

3 pcs.



Size: 30x30 cm
Barcode: 5005846419257
Packaging: 80 pcs.

art. CC906

MICROFIBER CLOTH UNIVERSAL



Size: 30x40 cm
Barcode: 5005846419066
Packaging: 240 pcs.

art. CC926

MICROFIBER CLOTH UNIVERSAL



Size: 30x40 cm
Barcode: 5005846419264
Packaging: 240 pcs.

art. CC936

MICROFIBER CLOTH UNIVERSAL



Size: 30x40 cm
Barcode: 5005846419363
Packaging: 240 pcs.

art. CC915

MICROFIBER CLOTH SET 3 pcs. UNIVERSAL, FOR POLISHING, FOR GLASS



Size: 30x30 cm
Barcode: 5005846429157
Packaging: 80 pcs.

art. CC905

MICROFIBER CLOTH SET 3 pcs. UNIVERSAL, FOR POLISHING, FOR GLASS

Size: 30x40 cm
Barcode: 5005846419059
Packaging: 120 pcs.



art. **CL411**

CAR CLEANING SPONGE **SPECIAL**



Size: 220x120x60 mm
Barcode: 4820252241527
Packaging: 50 pcs.

art. **CL413**

CAR CLEANING SPONGE **MAXI**



Size: 240x160x70 mm
Barcode: 4820252241541
Packaging: 50 pcs.

art. **CL418**

CAR CLEANING SPONGE
CLASSIC



Size: 200x120x60 mm
Barcode: 4820252241572
Packaging: 50 pcs.

art. **TN063**

LUGGAGE NET

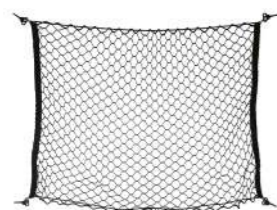

Size: 70x90 cm
Fastening: 4 hooks
Cell size: 3x3 cm
Barcode: 5005846280635
Packaging: 24 pcs.



art. **CL412**

CAR CLEANING SPONGE **SOFT**



Size: 220x120x60 mm
Barcode: 4820252241534
Packaging: 50 pcs.

art. **CL415**

CAR CLEANING SPONGE **SUPER**



Size: 200x130x70 mm
Barcode: 4820252241558
Packaging: 50 pcs.

art. **CL422**

CAR CLEANING SPONGE
PREMIUM



Size: 190x120x70 mm
Barcode: 4820252241589
Packaging: 50 pcs.

art. **CL417**

CAR CLEANING SPONGE
ECO



Size: 190x140x50 mm
Barcode: 4820252241565
Packaging: 25 pcs.

art. **TN069**

LUGGAGE NET

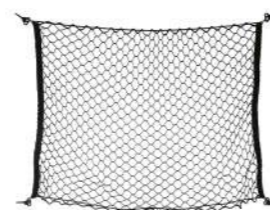

Size: 60x115 cm
Fastening: 4 hooks
Cell size: 3x3 cm
Barcode: 5005846280697
Packaging: 24 pcs.



art. **ES501**

ELASTIC STRAPS
WITH HOOKS



Quantity: 2 pcs.
Length: 80 cm
Barcode: 5005846415013
Packaging: 100 pcs.

art. **ES502**

ELASTIC STRAPS
WITH HOOKS



Quantity: 2 pcs.
Length: 100 cm
Barcode: 5005846415020
Packaging: 100 pcs.

art. **ES503**

ELASTIC STRAPS
WITH HOOKS



Quantity: 2 pcs.
Length: 120 cm
Barcode: 5005846415037
Packaging: 100 pcs.



art. **TO120**

TRUNK ORGANIZER

Color: **black**
Quantity of sections: 2
Dimensions: 52x26x28 cm
Barcode: 4820240523185



art. **TO130**

TRUNK ORGANIZER

Color: **black**
Quantity of sections: 2
Dimensions: 55x29x29 cm
Barcode: 4820240523192



art. **TO149**

TRUNK ORGANIZER

Color: **black**
Quantity of sections: 2
Dimensions: 58x34x31 cm
Barcode: 4820240523208



art. BT101

BATTERY TERMINALS



Material: zinc, brass coating
Barcode: 5005846201913
Packaging: 200 pcs.

art. BT103

BATTERY TERMINALS



Material: lead
Barcode: 5005846201937
Packaging: 160 pcs.

art. BT105

BATTERY TERMINALS



Material: zinc, copper coating
Barcode: 5005846201951
Packaging: 200 pcs.

art. BT106

BATTERY TERMINALS



Material: brass
Barcode: 5005846201968
Packaging: 200 pcs.

art. BT107

BATTERY TERMINALS



Material: finned steel, rubber insulation
Barcode: 5005846201975
Packaging: 200 pcs.

art. BT109

BATTERY TERMINALS



Material: lead
Barcode: 5005846201999
Packaging: 200 pcs.

art. CS301

CIGARETTE LIGHTER SOCKET 3in1 + USB
COPPER CABLE 0,6 m WITH FUSE



Voltage: 12 V
Current: 5 A
Barcode: 5005846423018
Packaging: 100 pcs.



art. CS302

CIGARETTE LIGHTER SOCKET 3in1 + USB
WITH LED BACKLIGHT AND WITH FUSE



Voltage: 12 V
Current: 5 A
Barcode: 5005846423025
Packaging: 100 pcs.



art. CS303

CIGARETTE LIGHTER SOCKET 2B1 + USB
COPPER CABLE 0,5 m WITH FUSE



Voltage: 12 V
Current: 5 A
Barcode: 5005846423032
Packaging: 100 pcs.



art. CS304

CIGARETTE LIGHTER SOCKET 2in1 + 2 USB
COPPER CABLE 0,6 m WITH FUSE



Voltage: 12 V
Current: 5 A
Barcode: 5005846423049
Packaging: 100 pcs.



art. LC421

CIGARETTE LIGHTER EURO
WITH BACKLIGHT



Nominal voltage : 12 V
Current: 10 A
Barcode: 5005846414214
Packaging: 200 pcs.

art. LC422

CIGARETTE LIGHTER
STANDARD



Nominal voltage: 12 V
Current: 10 A
Barcode: 5005846414221
Packaging: 200 pcs.

art. SP500

ANTI-SLIP MAT

Size: 300x1500 mm
Barcode: 5005846415006
Packaging: 24/48 pcs.



art. SP518

ANTI-SLIP MAT

Size: 130x160 mm
Barcode: 5015846415181
Packaging: 200 pcs.



art. LC423

CIGARETTE LIGHTER
STANDARD
WITH BACKLIGHT



Nominal voltage: 12 V
Current: 10 A
Barcode: 5005846414238
Packaging: 200 pcs.

art. LC424

CAR LIGHTER
PLUG



Nominal voltage: 12 V
Current: 10 A
Barcode: 5005846414245
Packaging: 250 pcs.

art. SP511

ANTI-SLIP MAT

Size: 93x146 mm
Barcode: 5005846415112
Packaging: 200 pcs.



art. SP512

ANTI-SLIP MAT

Size: 192x210 mm
Barcode: 5005846415129
Packaging: 200 pcs.

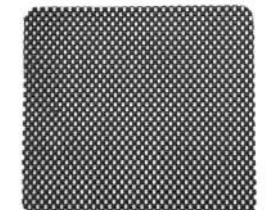

art. PH601

CAR PHONE HOLDER



Barcode: 5005846416010
Packaging: 60 pcs.

art. PH602

CAR PHONE HOLDER



Barcode: 5005846416027
Packaging: 60 pcs.

art. PH613

MAGNETIC CAR PHONE HOLDER



Barcode: 5005846416133
Packaging: 95 pcs.

art. PH608

MAGNETIC CAR PHONE HOLDER



Barcode: 5005846416089
Packaging: 200 pcs.

art. PH603

CAR PHONE HOLDER



Barcode: 5005846416034
Packaging: 60 pcs.

art. PH604

CAR PHONE HOLDER



Barcode: 5005846416041
Packaging: 100 pcs.

art. PH609

MAGNETIC CAR PHONE HOLDER

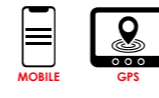

Barcode: 5005846416096
Packaging: 200 pcs.

art. PH610

MAGNETIC CAR PHONE HOLDER



Barcode: 5005846416102
Packaging: 200 pcs.

art. PH605

CAR PHONE HOLDER



Barcode: 5005846416058
Packaging: 100 pcs.

art. PH607

CAR PHONE HOLDER



Barcode: 5005846416072
Packaging: 50 pcs.

art. PH611

MAGNETIC CAR PHONE HOLDER



POWERFUL MAGNET



Barcode: 5005846416119
Packaging: 130 pcs.

art. PH612

MAGNETIC CAR PHONE HOLDER



POWERFUL MAGNET



Barcode: 5005846416126
Packaging: 156 pcs.

art. PH606

MAGNETIC CAR PHONE HOLDER



POWERFUL MAGNET



Barcode: 5005846416065
Packaging: 200 pcs.

art. VM105

BLIND SPOT MIRROR CONVEX,
DIAMETER 45 mm, 360°
SET 2 pcs.



Barcode: 5005846421052
Packaging: 200 pcs.

art. VM110

BLIND SPOT MIRROR CONVEX,
ADJUSTABLE TILT ANGLE
SET 2 pcs.



Barcode: 5005846421106
Packaging: 100 pcs.

art. VM115

AUXILIARY MIRROR
FOR MOUNTING ON A STANDARD MIRROR,
ADJUSTABLE TILT ANGLE



Barcode: 5005846421151
Packaging: 100 pcs.

art. VM150

REAR VIEW MIRROR,
150 mm, 360°



Barcode: 5005846421502
Packaging: 40 pcs.

art. SB310

SAFETY BELT CLIP



Barcode: 5005846423100
Packaging: 200 pcs.

art. AT010

HYDROMETER FOR ELECTROLYTE



Barcode: 5005846230104
Packaging: 100 pcs.

art. AT011

HYDROMETER FOR ANTIFREEZE



Barcode: 5005846230111
Packaging: 100 pcs.

art. SS044

SIDE SUN SHADE,
44X38 cm, 2 pcs.

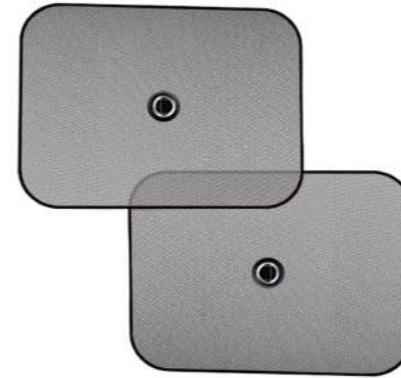

Barcode: 5005846410445
Packaging: 100 pcs.

art. SS065

SIDE SUN SHADE,
65X38 cm, 2 pcs.



Barcode: 5005846410650
Packaging: 100 pcs.

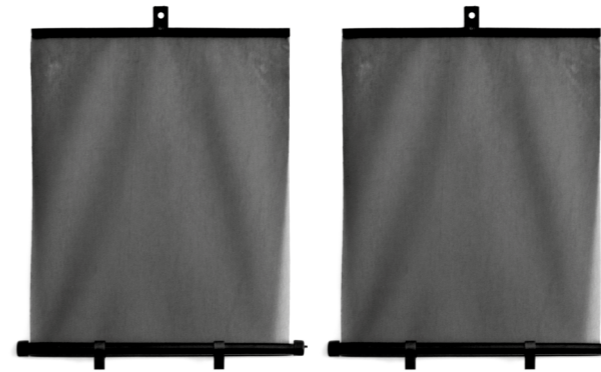

art. SS045

SIDE SUN SHADE, ON THE ROLL
55X45 cm, 2 pcs.

Barcode: 5005846410452
Packaging: 50 pcs.

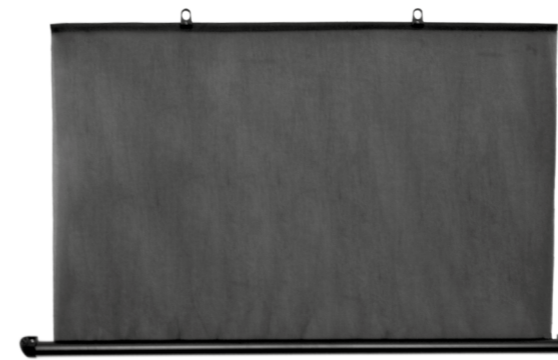

SIDE SUN SHADE, ON THE ROLL

art. SS090

90x57 cm

Barcode: 5005846410902
Packaging: 30 pcs.

art. SS100

100x57 cm

Barcode: 5005846411008
Packaging: 30 pcs.

art. SS110

110x57 cm

Barcode: 5005846411107
Packaging: 30 pcs.

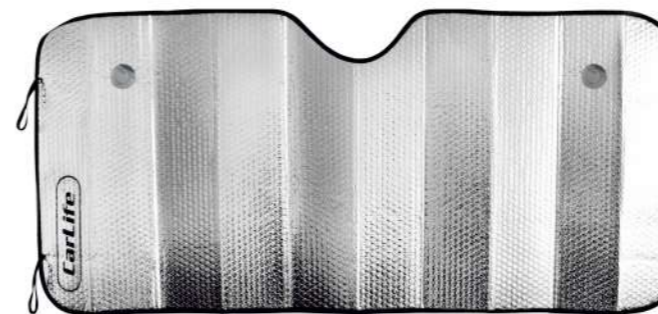

SIDE SUN SHADE, FRONTAL

art. SS130

130x60 cm

Barcode: 5005846411305
Packaging: 60 pcs.

art. SS145

145x70 cm

Barcode: 5005846411459
Packaging: 50 pcs.

art. SS150

150x80 cm

Barcode: 5005846411503
Packaging: 50 pcs.

Stainless steel licence plate holder

NH400 STAINLESS STEEL LICENCE PLATE HOLDER, CHROME



Barcode : 5005846204006
Packaging : 50 pcs.

NH420 STAINLESS STEEL LICENCE PLATE HOLDER, BLACK MATT



Barcode : 5005846204204
Packaging : 50 pcs.

NH430 STAINLESS STEEL LICENCE PLATE HOLDER, BLACK GLOSSY



Barcode : 5005846204303
Packaging : 50 pcs.

NH440 STAINLESS STEEL LICENCE PLATE HOLDER, GLOSSY WHITE



Barcode : 5005846204402
Packaging : 50 pcs.

Stainless steel licence plate holder
USA type

NH450 LICENCE PLATE HOLDER, CHROME



Hole mounting : 4 pcs.
Barcode : 5005846214500
Packaging : 50 pcs.

NH460 LICENCE PLATE HOLDER, CHROME



Hole mounting : 2 pcs.
Barcode : 5005846224608
Packaging : 50 pcs.

NH470 LICENCE PLATE HOLDER, MATT BLACK



Hole mounting : 4 pcs.
Barcode : 5005846234706
Packaging : 50 pcs.

NH480 LICENCE PLATE HOLDER, MATT BLACK



Hole mounting : 2 pcs.
Barcode : 5005846244804
Packaging : 50 pcs.

art. FL001

PLASTIC CAR FUNNEL
UNIVERSAL
with elastic nozzle



Barcode: 5005846204518
Packaging: 80 pcs.

art. FL002

PLASTIC CAR FUNNEL
STRAIGHT
with elastic nozzle



Barcode: 5005846204525
Packaging: 100 pcs.

art. FL003

PLASTIC CAR FUNNEL
OBLIQUE
with elastic nozzle



Barcode: 5005846204532
Packaging: 100 pcs.

art. CA5

PLASTIC JERRY CAN
FOR FUEL WITH FUNNEL

5L



Volume: 5 L
Barcode: 5005846204419
Packaging: 12 pcs.

art. CA10

PLASTIC JERRY CAN
FOR FUEL WITH FUNNEL

10L



Volume: 10 L
Barcode: 5005846204426
Packaging: 5 pcs.

art. CA20

PLASTIC JERRY CAN
FOR FUEL WITH FUNNEL

20L



Volume: 20 L
Barcode: 5005846204433
Packaging: 4 pcs.

art. WK544

STEERING WHEEL
KNOB, CARBON



Barcode: 5005846415440
Packaging: 100 pcs.

art. WK541

STEERING WHEEL
KNOB, METAL +
PLASTIC



Barcode: 5005846415419
Packaging: 50 pcs.

art. SK596

GEAR SHIFT KNOB,
WOOD



Barcode: 5005846415969
Packaging: 50 pcs.

art. SK599

GEAR SHIFT KNOB,
LEATHER



Barcode: 5005846415990
Packaging: 50 pcs.

art. SK600

GEAR SHIFT KNOB,
LEATHER



Barcode: 5005846416003
Packaging: 50 pcs.

Braids for the steering wheel of light vehicles
leather with one seam

Article	Size	Steering wheel diameter	Steering wheel thickness	Width cover
CW35/37	S	35-37 cm	25-30 mm	8,4 cm
CW37/39	M	37-39 cm	25-30 mm	8,4 cm
CW137/39	M	37-39 cm	30-35 mm	9,4 cm
CW39/41	L	39-41 cm	25-30 mm	8,4 cm
CW139/41	L	39-41 cm	30-35 mm	9,4 cm
CW41/43	XL	41-43 cm	25-30 mm	8,4 cm
CW141/43	XL	41-43 cm	30-35 mm	9,4 cm



art. **SW581**
STEERING WHEEL COVER



art. **SW582**
STEERING WHEEL COVER



art. **SW583**
STEERING WHEEL COVER



Barcode : 5005846415815
Packaging: 100 pcs.



Barcode : 5005846415822
Packaging: 100 pcs.



Barcode : 5005846415839
Packaging: 100 pcs.



art. **SW327**
M 37-39 cm
L 39-41 cm
Packaging: 20 pcs.



art. **SW329**
M 37-39 cm
L 39-41 cm
Packaging: 20 pcs.



art. **SW331**
M 37-39 cm
L 39-41 cm
Packaging: 20 pcs.



art. **SW332**
M 37-39 cm
L 39-41 cm
Packaging: 20 pcs.



art. **SW333**
M 37-39 cm
L 39-41 cm
Packaging: 20 pcs.



art. **SW334**
M 37-39 cm
L 39-41 cm
Packaging: 20 pcs.



art. **SW335**

M 37-39 cm
L 39-41 cm

Packaging: 20 pcs.



art. **SW336**

M 37-39 cm
L 39-41 cm

Packaging: 20 pcs.



art. **SW337**

M 37-39 cm
L 39-41 cm

Packaging: 20 pcs.



art. **SW338**

M 37-39 cm
L 39-41 cm

Packaging: 20 pcs.



art. **SW226**

S 35-37 cm
M 37-39 cm
L 39-41 cm
XL 41-43 cm

Packaging: 20 pcs.



art. **SW227**

S 35-37 cm
M 37-39 cm
L 39-41 cm
XL 41-43 cm

Packaging: 20 pcs.



art. **SW228**

S 35-37 cm
M 37-39 cm
L 39-41 cm
XL 41-43 cm

Packaging: 20 pcs.



art. **SW230**

S 35-37 cm
M 37-39 cm
L 39-41 cm
XL 41-43 cm

Packaging: 20 pcs.



art. **SW231**

S 35-37 cm
M 37-39 cm
L 39-41 cm
XL 41-43 cm

Packaging: 20 pcs.



art. **SW232**

S 35-37 cm
M 37-39 cm
L 39-41 cm
XL 41-43 cm

Packaging: 20 pcs.



art. **SW225**

S 35-37 cm
M 37-39 cm
L 39-41 cm
XL 41-43 cm
XXL 44-46 cm
XXXL 47-49 cm
XXXXL 50-52 cm

Packaging: 20 pcs.



art. **SW229**

S 35-37 cm
M 37-39 cm
L 39-41 cm
XL 41-43 cm
XXL 44-46 cm
XXXL 47-49 cm
XXXXL 50-52 cm

Packaging : 20 pcs.



art. **SW233**

S 35-37 cm
M 37-39 cm
L 39-41 cm
XL 41-43 cm

Packaging: 20 pcs.



art. **SW234**

S 35-37 cm
M 37-39 cm
L 39-41 cm
XL 41-43 cm

Packaging: 20 pcs.



art. **SW111**

S 35-37 cm
M 37-39 cm
L 39-41 cm
XL 41-43 cm

Packaging: 20 pcs.



art. **SW112**

S 35-37 cm
M 37-39 cm
L 39-41 cm
XL 41-43 cm

Packaging : 20 pcs.



art. **SW113**

S 35-37 cm
M 37-39 cm
L 39-41 cm
XL 41-43 cm

Packaging : 20 pcs.



art. **SW114**

S 35-37 cm
M 37-39 cm
L 39-41 cm
XL 41-43 cm

Packaging : 20 pcs.



art. **SW115**

S 35-37 cm
M 37-39 cm
L 39-41 cm
XL 41-43 cm

Packaging: 20 pcs.



art. **SW121**

M 37-39 cm
L 39-41 cm
XL 41-43 cm

Packaging: 20 pcs.



art. **SW122**

M 37-39 cm
L 39-41 cm
XL 41-43 cm

Packaging: 20 pcs.



art. **SW123**

M 37-39 cm
L 39-41 cm
XL 41-43 cm

Packaging: 20 pcs.



art. **SW124**

M 37-39 cm
L 39-41 cm
XL 41-43 cm

Packaging: 20 pcs.



art. **SW125**

M 37-39 cm
L 39-41 cm
XL 41-43 cm

Packaging: 20 pcs.



art. **SW126**

M 37-39 cm
L 39-41 cm
XL 41-43 cm

Packaging: 20 pcs.



art. **SW127**

M 37-39 cm
L 39-41 cm
XL 41-43 cm

Packaging: 20 pcs.



art. **SW128**

M 37-39 cm
L 39-41 cm
XL 41-43 cm

Packaging: 20 pcs.



art. **SW129**

M 37-39 cm
L 39-41 cm
XL 41-43 cm

Packaging: 20 pcs.

CarLife[®]

PROFESSIONAL TOOLS



COMBINATION WRENCH

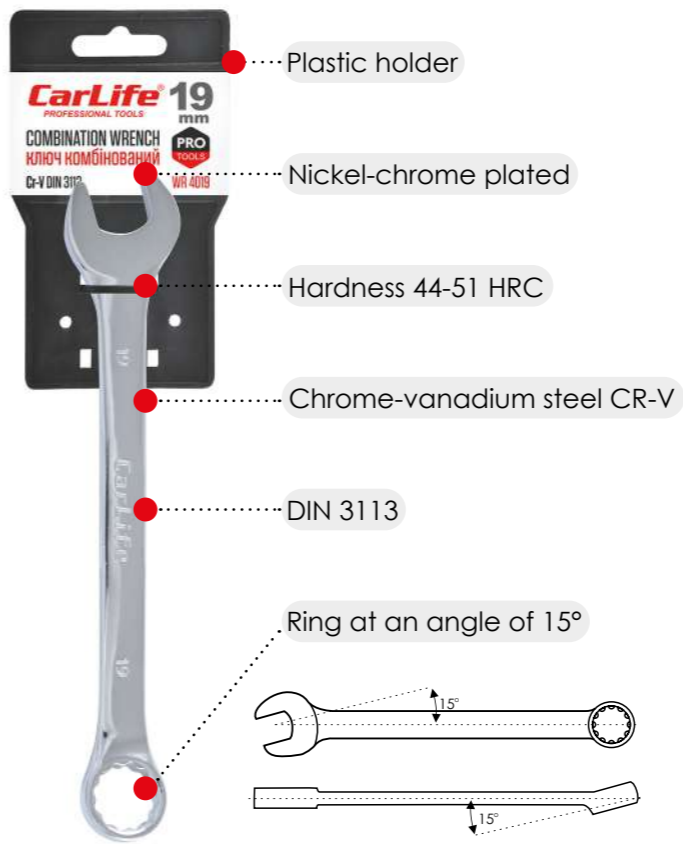

ARTICLE	SIZE	BARCODE	PACKAGING
WR 3006	6mm	5000589530061	10/250
WR 3007	7mm	5000589530078	10/250
WR 3008	8mm	5000589530085	10/250
WR 3009	9mm	5000589530092	10/250
WR 3010	10mm	5000589530108	10/200
WR 3011	11mm	5000589530115	10/200
WR 3012	12mm	5000589530122	10/200
WR 3013	13mm	5000589530139	10/200
WR 3014	14mm	5000589530146	10/150
WR 3015	15mm	5000589530153	10/150
WR 3016	16mm	5000589530160	5/150
WR 3017	17mm	5000589530177	5/100
WR 3018	18mm	5000589530184	5/100
WR 3019	19mm	5000589530191	5/100
WR 3020	20mm	5000589530207	5/50
WR 3021	21mm	5000589530214	5/50
WR 3022	22mm	5000589530221	5/50
WR 3023	23mm	5000589530238	5/50
WR 3024	24mm	5000589530245	5/50
WR 3025	25mm	5000589530252	5/40
WR 3026	26mm	5000589530269	5/40
WR 3027	27mm	5000589530276	5/20
WR 3028	28mm	5000589530283	5/20
WR 3029	29mm	5000589530290	5/20
WR 3030	30mm	5000589530306	5/20
WR 3032	32mm	5000589530320	5/20

COMBINATION WRENCH IN INDUSTRIAL PACKAGING

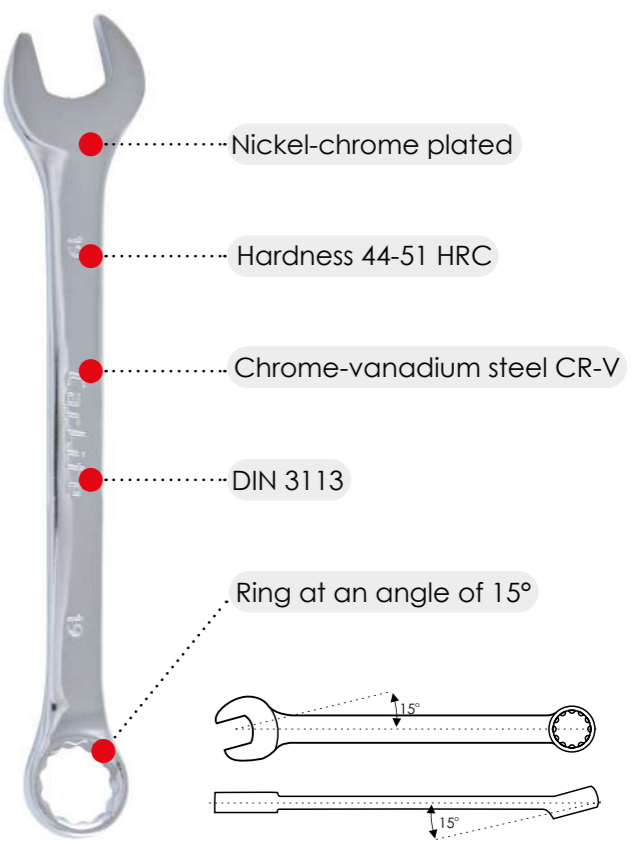

ARTICLE	SIZE	BARCODE	PACKAGING
WR 4006	6mm	5000589540060	10/250
WR 4007	7mm	5000589540077	10/250
WR 4008	8mm	5000589540084	10/250
WR 4009	9mm	5000589540091	10/250
WR 4010	10mm	5000589540107	10/200
WR 4011	11mm	5000589540114	10/200
WR 4012	12mm	5000589540121	10/200
WR 4013	13mm	5000589540138	10/200
WR 4014	14mm	5000589540145	10/150
WR 4015	15mm	5000589540152	10/150
WR 4016	16mm	5000589540169	5/150
WR 4017	17mm	5000589540176	5/100
WR 4018	18mm	5000589540183	5/100
WR 4019	19mm	5000589540190	5/100
WR 4020	20mm	5000589540206	5/50
WR 4021	21mm	5000589540213	5/50
WR 4022	22mm	5000589540220	5/50
WR 4023	23mm	5000589540237	5/50
WR 4024	24mm	5000589540244	5/50
WR 4025	25mm	5000589540251	5/40
WR 4026	26mm	5000589540268	5/40
WR 4027	27mm	5000589540275	5/20
WR 4028	28mm	5000589540282	5/20
WR 4029	29mm	5000589540299	5/20
WR 4030	30mm	5000589540305	5/20
WR 4032	32mm	5000589540329	5/20



art. WR 4208

Wrench set : 8 pcs.
Size : 8-10-12-13-14-15-17-19 mm
Barcode : 5000589542088
Packaging : 20 pcs.



art. WR 4212

Wrench set : 12 pcs.
Size : 6-7-8-9-10-12-13-14-15-17-19-22 mm
Barcode : 5000589542125
Packaging : 10 pcs.



art. WR 4215

Wrench set : 15 pcs.
Size : 6-7-8-9-10-11-12-13-14-15-16-17-18-19-22 mm
Barcode : 5000589542156
Packaging : 10 pcs.



art. WR 4214

Wrench set : 14 pcs.
Size : 8-10-12-13-14-16-17-19-21-22-24-27-30-32 mm
Barcode : 5000589542149
Packaging : 4 pcs.



art. WR 4217

Wrench set : 17 pcs.
Size : 6-7-8-9-10-11-12-13-14-15-16-17-18-19-21-22-24 mm
Barcode : 5000589542170
Packaging : 8 pcs.



art. WR 4226

Wrench set : 26 pcs.
Size : 6-7-8-9-10-11-12-13-14-15-16-17-18-19-20-21-22-23-24-25-26-27-28-29-30-32 mm
Barcode : 5000589542262
Packaging : 2 pcs.

TUBE WRENCH



ARTICLE	SIZE	BARCODE	PACKAGING
WR 2007	6x7mm	5000589520079	10/200
WR 2010	8x10mm	5000589520109	10/200
WR 2013	12x13mm	5000589520130	10/200
WR 2015	14x15mm	5000589520154	10/100
WR 2017	16x17mm	5000589520178	10/100
WR 2019	18x19mm	5000589520192	10/100
WR 2022	21x22mm	5000589520222	10/100

- Plastic holder
- Carbon steel C45
- Matte coating



art. WR 2222

Wrench set : 7 pcs.
Size : 6x7-8x10-12x13-14x15-16x17-18x19-21x22 mm
Barcode : 5000589522226
Packaging : 20 pcs.

SCREWDRIVER PHILLIPS



Magnetized tip

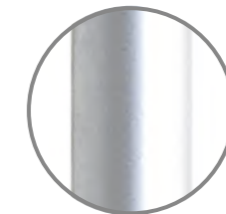

Chrome-vanadium steel



Two-component ergonomic handle

SCREWDRIVER SLOTTED



Magnetized tip



Chrome-vanadium steel



Two-component ergonomic handle

PROFESSIONAL TOOLS

ARTICLE	SIZE	BARCODE	PACKAGING
WR 6075	PH0x75mm	5000589560754	12/480
WR 6010	PH0x100mm	5000589560105	12/480
WR 6110	PH1x100mm	5000589561102	12/240
WR 6115	PH1x150mm	5000589561157	12/240
WR 6210	PH2x100mm	5000589562109	12/240
WR 6215	PH2x150mm	5000589562154	12/180
WR 6220	PH2x200mm	5000589562208	12/180

INNOVATIVE
TECHNOLOGIES

ARTICLE	SIZE	BARCODE	PACKAGING
WR 6375	SL 3x75mm	5000589563755	12/480
WR 6310	SL 3x100mm	5000589563106	12/480
WR 6510	SL 5x100mm	5000589565100	12/240
WR 6515	SL 5x150mm	5000589565155	12/240
WR 6610	SL 6x100mm	5000589566107	12/240
WR 6615	SL 6x150mm	5000589566152	12/180
WR 6620	SL 6x200mm	5000589566206	12/180

SCREWDRIVER SET



art. WR 6904
 Cr-V 6150
 SL 3×75MM - PH0×75MM +
 SL 6×100MM - PH2×100MM +
 Screwdriver set : 4 pcs.
 Barcode : 5000589569047
 Packaging : 12/48



art. WR 6907
 Cr-V 6150
 SL 5×75MM - PH0×75MM +
 SL 5×150MM - PH1×75MM +
 SL 6×125MM - PH2×100MM +
 SL 8×150MM -
 Screwdriver set : 7 pcs.
 Barcode : 5000589569078
 Packaging : 12/36

INNOVATIVE TECHNOLOGIES



art. WR 6906
 Cr-V 6150
 SL 3×75MM - PH0×75MM +
 SL 5×100MM - PH1×100MM +
 SL 6×100MM - PH2×100MM +
 Screwdriver set : 6 pcs.
 Barcode : 5000589569046
 Packaging : 12/48



art. WR 6910
 Cr-V 6150
 SL 3×75MM - PH0×75MM +
 SL 5×100MM - PH1×100MM +
 SL 6×38MM - PH2×38MM +
 SL 6×100MM - PH2×100MM +
 SL 8×150MM - PH3×150MM +
 Screwdriver set : 10 pcs.
 Barcode : 5000589569108
 Packaging : 12/24

TORX KEY WRENCH SET



art. WR 2111

A set of L-shaped universal TORX socket wrenches with a hole.
 • made of high-quality chrome vanadium steel with a matte finish.
 • resistant to rapid deformation and abrasion.
 • packed in plastic packaging with partitions and size markings.

Wrench set : 9 pcs.
 Size : T10, T15, T20, T25, T27, T30, T40, T45, T50
 Barcode : 5000589521113
 Packaging : 60 pcs.

art. WR 2112

A set of L-shaped universal TORX socket wrenches with a hole.
 • made of high-quality chrome vanadium steel with a matte finish.
 • resistant to rapid deformation and abrasion.
 • packed in plastic packaging with partitions and size markings.

Wrench set : 9 pcs.
 Size : T10, T15, T20, T25, T27, T30, T40, T45, T50
 Barcode : 5000589621127
 Packaging : 40 pcs.

art. WR 2113

A set of L-shaped universal TORX socket wrenches with a hole.
 • made of high-quality chrome vanadium steel with a matte finish.
 • resistant to rapid deformation and abrasion.
 • packed in plastic packaging with partitions and size markings.

Wrench set : 9 pcs.
 Size : T10, T15, T20, T25, T27, T30, T40, T45, T50
 Barcode : 5000589721131
 Packaging : 40 pcs.

HEX KEY WRANCH SET

art. WR 2114

A set of L-shaped hex wrenches.
 • made of high-quality chrome vanadium steel with a matte finish.
 • resistant to rapid deformation and abrasion.
 • packed in plastic packaging with partitions and size markings.

Wrench set : 9 pcs.
 Size : 1.5, 2, 2.5, 3, 4, 5, 6, 8, 10 mm
 Barcode : 5000589821145
 Packaging : 60 pcs.

art. WR 2115

A set of L-shaped hex wrenches.
 • made of high-quality chrome vanadium steel with a matte finish.
 • resistant to rapid deformation and abrasion.
 • packed in plastic packaging with partitions and size markings.

Wrench set : 9 pcs.
 Size : 1.5, 2, 2.5, 3, 4, 5, 6, 8, 10 mm
 Barcode : 500058921159
 Packaging : 40 pcs.



art. WR 2116

A set of L-shaped hex wrenches.
 • made of high-quality chrome vanadium steel with a matte finish.
 • resistant to rapid deformation and abrasion.
 • packed in plastic packaging with partitions and size markings.

Wrench set : 9 pcs.
 Size : 1.5, 2, 2.5, 3, 4, 5, 6, 8, 10
 Barcode : 5000590021169
 Packaging : 40 pcs.



BALL HEAD HEX KEY WRANCH SET



art. WR 2117

A set of L-shaped wrenches with a ball end.
 • made of high-quality chrome vanadium steel with a matte finish.
 • resistant to rapid deformation and abrasion.
 • ball end allows working at an angle of up to 25°.
 • packed in plastic packaging with partitions and size markings.

Wrench set : 9 pcs.
 Size : 1.5, 2, 2.5, 3, 4, 5, 6, 8, 10 mm
 Barcode : 5000590121173
 Packaging : 60 pcs.



art. WR 2118

A set of L-shaped wrenches with a ball end.
 • made of high-quality chrome vanadium steel with a matte finish.
 • resistant to rapid deformation and abrasion.
 • ball end allows working at an angle of up to 25°.
 • packed in plastic packaging with partitions and size markings.

Wrench set : 9 pcs.
 Size : 1.5, 2, 2.5, 3, 4, 5, 6, 8, 10 mm
 Barcode : 5000590221187
 Packaging : 40 pcs.



art. WR 2119

A set of L-shaped wrenches with a ball end.
 • made of high-quality chrome vanadium steel with a matte finish.
 • resistant to rapid deformation and abrasion.
 • ball end allows working at an angle of up to 25°.
 • packed in plastic packaging with partitions and size markings.

Wrench set : 9 pcs.
 Size : 1.5, 2, 2.5, 3, 4, 5, 6, 8, 10 mm
 Barcode : 5000590321191
 Packaging : 40 pcs.



1.5	M1.6 M1.7 M2	—	—	M3	—	—	—
2	M2.3 M2.5 M2.6	M3	M3	M4	—	—	—
2.5	M3	M4	M4	M5	—	—	—
3	M4	M5	M5	M6	6MM	M3	M4
4	M5	M6	M6	M8	8MM	M4	M5
5	M6	M8	M8	M10	10MM	M5	M6
6	M8	M10	M10	M12	12MM	M6	M8
8	M10	M12	M12	M14	16MM	M8	M10
10	M12	M14 M16	—	M16 M20	20MM	M10	M12

T10	#4 M3 #5	M5	#5 M3 #6	#5 M3
T15	—	—	—	—
T20	—	1/4 M6	#8 M4	M4
T25	#8 M4	—	#10 M5	#10 M5
T27	#10 M5	5/16 M8	—	1/4
T30	1/4 M6	3/8	1/4 M6	M6
T40	—	M10	5/16 M8	5/16 M8
T45	5/16 M8	1/12 M12	3/8	3/8
T50	5/16 M10	M14	7/16 M10 1/2	M10

LONG-NOSE PLIERS

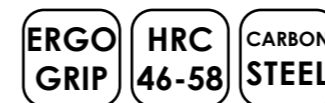

Pliers with straight edges for cutting and forming wire. Designed for work with medium and heavy loads.
 • made of high quality polished tool steel.
 • cutting edges with high hardness in the range of 46-58 HRC.
 • hardened and ground.
 • strong and resistant to deformation.
 • ergonomic two-component handle.

ARTICLE	SIZE	BARCODE	PACKAGING
WR 5513	160mm	5000589555132	6/60
WR 5514	180mm	5000589555149	6/60
WR 5515	200mm	5000589555156	6/60

COMBINATION PLIERS



Pliers are combined with cutting edges for cutting and forming wire. Designed for work with medium and heavy loads.
 • made of high quality polished tool steel.
 • cutting edges with high hardness in the range of 46-58 HRC.
 • hardened and ground.
 • strong and resistant to deformation.
 • ergonomic handle.

ARTICLE	SIZE	BARCODE	PACKAGING
WR 5010	160mm	5000589550106	6/60
WR 5011	180mm	5000589550113	6/60
WR 5012	200mm	5000589550120	6/60

LONG-NOSE PLIERS



Pliers with straight edges for cutting and forming wire. Designed for work with medium and heavy loads.
 • made of high quality polished tool steel.
 • cutting edges with high hardness in the range of 46-58 HRC.
 • hardened and ground.
 • strong and resistant to deformation.
 • ergonomic handle.

ARTICLE	SIZE	BARCODE	PACKAGING
WR 5013	160mm	5000589550137	6/60
WR 5014	180mm	5000589550144	6/60
WR 5015	200mm	5000589550151	6/60

SIDE-CUTTING PLIERS

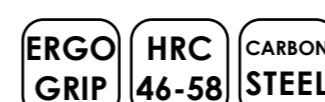

Side cutters pliers for cutting wire. Designed for work with medium and heavy loads.
 • made of high quality polished tool steel.
 • cutting edges with high hardness in the range of 46-58 HRC.
 • hardened and ground.
 • strong and resistant to deformation.
 • ergonomic handle.

ARTICLE	SIZE	BARCODE	PACKAGING
WR 5019	160mm	5000589550199	6/60
WR 5020	180mm	5000589550205	6/60
WR 5021	200mm	5000589550212	6/60

DIELECTRIC COMBINATION PLIERS



Combined dielectric pliers with cutting edges for cutting and forming cables and wire. Designed for work with medium and high voltage.

- made of high-quality polished black-nickel steel.
- with a high melting point and low electrical and thermal conductivity.
- cutting edges with high hardness in the range of 46-58 HRC.
- hardened and sharpened cutting edges.
- ergonomic insulated handle.

ARTICLE	SIZE	BARCODE	PACKAGING
WR 5029	160mm	5000589550298	6/60
WR 5022	180mm	5000589550229	6/60
WR 5023	200mm	5000589550236	6/60

TPE GRIP **HRC 46-58** **BLACK NICKEL**

DIELECTRIC LONG-NOSE PLIERS



Dielectric pliers for cutting cables and wires. Designed for work with medium and high voltage.

- made of high-quality polished black-nickel steel.
- with a high melting point and low electrical and thermal conductivity.
- cutting edges with high hardness in the range of 46-58 HRC.
- hardened and sharpened cutting edges.
- ergonomic insulated handle.

ARTICLE	SIZE	BARCODE	PACKAGING
WR 5024	160mm	5000589550243	6/60

TPE GRIP **HRC 46-58** **BLACK NICKEL**

DIELECTRIC BENT-NOSE PLIERS



Curved dielectric pliers for cutting cables and wires. Designed for work with medium and high voltage.

- made of high-quality polished black-nickel steel.
- with a high melting point and low electrical and thermal conductivity.
- cutting edges with high hardness in the range of 46-58 HRC.
- hardened and sharpened cutting edges.
- ergonomic insulated handle.

ARTICLE	SIZE	BARCODE	PACKAGING
WR 5025	160mm	5000589550250	6/60

TPE GRIP **HRC 46-58** **BLACK NICKEL**

DIELECTRIC SIDE-CUTTING PLIERS



Dielectric side cutters for cutting cables and wire. Designed for work with medium and high voltage.

- made of high-quality polished black-nickel steel.
- with a high melting point and low electrical and thermal conductivity.
- cutting edges with high hardness in the range of 46-58 HRC.
- hardened and sharpened cutting edges.
- ergonomic insulated handle.

ARTICLE	SIZE	BARCODE	PACKAGING
WR 5026	160mm	5000589550267	6/60

TPE GRIP **HRC 46-58** **BLACK NICKEL**

HEAVY DUTY DIELECTRIC SIDE-CUTTING PLIERS



Dielectric side cutters for cutting cables and wire. Designed for work with medium and high voltage.

- made of high-quality polished black-nickel steel.
- with a high melting point and low electrical and thermal conductivity.
- cutting edges with high hardness in the range of 46-58 HRC.
- hardened and sharpened cutting edges.
- ergonomic insulated handle.

ARTICLE	SIZE	BARCODE	PACKAGING
WR 5027	170mm	5000589550274	6/60

TPE GRIP **HRC 46-58** **BLACK NICKEL**

DIELECTRIC ROUND-NOSE PLIERS



Dielectric reinforced side cutters for cutting cables and wire. Designed for work with medium and high voltage.

- made of high-quality polished black-nickel steel.
- with a high melting point and low electrical and thermal conductivity.
- cutting edges with high hardness in the range of 46-58 HRC.
- hardened and sharpened cutting edges.
- ergonomic insulated handle.

ARTICLE	SIZE	BARCODE	PACKAGING
WR 5028	160mm	5000589550281	6/60

TPE GRIP **HRC 46-58** **BLACK NICKEL**

Gas Torch

WITH AUTOMATIC PIEZO IGNITION



art. GT 507
GAS TORCH WITH AUTOMATIC PIEZO IGNITION

1300 °C
t°C max

90 grams
hour

19 mm
nozzle

153 mm
length



Power: 1,3 kW
Nozzle protection: ceramic
Ignition type: automatic
Type of fastening: collet
Barcode: 5005856205079
Packaging: 10/100 pcs.

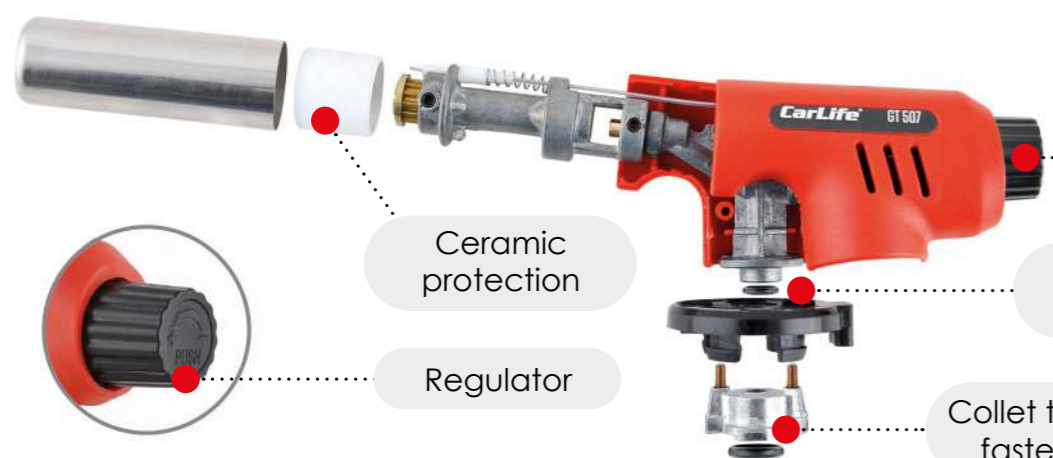

art. GT 505
GAS TORCH WITH AUTOMATIC PIEZO IGNITION

1300 °C
t°C max

82 grams
hour

175 mm
length

19 mm
nozzle



Power: 1,3 kW
Nozzle protection: ceramic
Ignition type: automatic
Barcode: 5005856205055
Packaging: 10/100 pcs.

art. GT 504

GAS TORCH WITH AUTOMATIC PIEZO IGNITION



Power: 1,3 kW
Ignition type: automatic
Barcode: 5005856205048
Packaging: 10/100 pcs.

1300 °C
t°C max

90 grams
hour

198 mm
length

13,6 mm
nozzle

art. GT 503

GAS TORCH WITH AUTOMATIC PIEZO IGNITION



Power: 1,3 kW
Ignition type: automatic
Barcode: 5005856205031
Packaging: 10/100 pcs.

1300 °C
t°C max

90 grams
hour

144 mm
length

20 mm
nozzle

art. GT 502
GAS TORCH

1300 °C
t°C max

90 grams
hour

200 mm
length

25 mm
nozzle



Power: 1,3 kW
Ignition type: manual
Barcode: 5005856205024
Packaging: 10/100 pcs.

art. GT 506

GAS TORCH WITH AUTOMATIC PIEZO IGNITION



Power: 1,3 kW
Nozzle protection: ceramic
Ignition type: automatic
Barcode: 5005856205062
Packaging: 10/100 pcs.

1300 °C
t°C max

95 grams
hour

166 mm
length

19 mm
nozzle

art. GT 501
GAS TORCH



Power: 1,3 kW
Ignition type: manual
Barcode: 5005856205017
Packaging: 10/100 pcs.

1300 °C
t°C max

90 grams
hour

210 mm
length

32 mm
nozzle

art. GT 500
GAS TORCH



Power: 1,3 kW
Ignition type: manual
Barcode: 5005856205000
Packaging: 10/100 pcs.

1300 °C
t°C max

90 grams
hour

195 mm
length

13,6 mm
nozzle



Color: Black
Material: Nylon 6.6
Safety standard: UL 62275



ISO 9001:2008



ARTICLE WIDTH, THICKNESS (mm) PACKAGING BARCODE

BL2.5x100	2,5x100	500	5005846251017
BL2.5x150	2,5x150	400	5005846251512
BL2.5x200	2,5x200	300	5005846252014
BL3.0x250	3,0x250	200	5005846732509
BL3.6x150	3,6x150	250	5005846361518
BL3.6x200	3,6x200	200	5005846362010
BL3.6x250	3,6x250	180	5005846362201
BL3.6x300	3,6x300	150	5005846363017
BL3.6x370	3,6x370	100	5005846363710
BL4.8x250	4,8x250	100	5005846472511
BL4.8x300	4,8x300	100	5005846473013
BL4.8x350	4,8x350	100	5005846473518
BL4.8x380	4,8x380	80	5005846473815
BL4.8x400	4,8x400	70	5005846474010
BL4.8x450	4,8x450	70	5005846474515
BL7.6x300	7,6x300	50	5005846763015
BL7.6x350	7,6x350	50	5005846763510
BL7.6x400	7,6x400	50	5005846764012
BL7.6x450	7,6x450	50	5005846764517
BL7.6x500	7,6x500	50	5005846765019
BL7.6x750	7,6x750	15	5005846767518

ARTICLE WIDTH, THICKNESS (mm) PACKAGING BARCODE

W2.5x100	2,5x100	500	5005846251000
W2.5x150	2,5x150	400	5005846251505
W2.5x200	2,5x200	300	5005846252007
W3.0x250	3,0x250	200	5005846362508
W3.6x150	3,6x150	250	5005846361501
W3.6x200	3,6x200	200	5005846362003
W3.6x250	3,6x250	180	5005846732516
W3.6x300	3,6x300	150	5005846363000
W3.6x370	3,6x370	100	5005846363703
W4.8x250	4,8x250	100	5005846472504
W4.8x300	4,8x300	100	5005846473006
W4.8x350	4,8x350	100	5005846473501
W4.8x380	4,8x380	80	5005846473808
W4.8x400	4,8x400	70	5005846474003
W4.8x450	4,8x450	70	5005846474508
W7.6x300	7,6x300	50	5005846763008
W7.6x350	7,6x350	50	5005846763503
W7.6x400	7,6x400	50	5005846764005
W7.6x450	7,6x450	50	5005846764500
W7.6x500	7,6x500	50	5005846765002
W7.6x750	7,6x750	15	5005846767501



Color: White
Material: Nylon 6.6
Safety standard: UL 62275



ISO 9001:2008



ARTICLE SIZE WIDTH, THICKNESS (mm) PACKAGING BARCODE

HC006010	6 - 10 9mm W1	9x0,67	100	5005846060107
HC008012	8 - 12 9mm W1	9x0,67	100	5005846080129
HC010016	10 - 16 9mm W1	9x0,67	100	5005846100162
HC012018	12 - 18 9mm W1	9x0,67	100	5005846120184
HC012022	12 - 22 9mm W1	9x0,67	100	5005846120221
HC016027	16 - 27 9mm W1	9x0,67	100	5005846160272
HC020032	20 - 32 9mm W1	9x0,67	100	5005846200329
HC025040	25 - 40 9mm W1	9x0,67	100	5005846250409
HC032050	32 - 50 9mm W1	9x0,67	50	5005846320508
HC040060	40 - 60 9mm W1	9x0,67	50	5005846400606
HC050070	50 - 70 9mm W1	9x0,67	50	5005846500702
HC060080	60 - 80 9mm W1	9x0,67	50	5005846600808
HC070090	70 - 90 9mm W1	9x0,67	25	5005846700904
HC080100	80 - 100 9mm W1	9x0,67	25	5005846801007
HC090110	90 - 110 9mm W1	9x0,67	25	5005846901103
HC100120	100 - 120 9mm W1	9x0,67	25	5005846001209
HC110130	110 - 130 9mm W1	9x0,67	25	5005846101305
HC120140	120 - 140 9mm W1	9x0,67	25	5005846201401
HC130150	130 - 150 9mm W1	9x0,67	25	5005846301507
HC140160	140 - 160 9mm W2	9x0,67	20	5005846401603





Die Wahl des Fachmanns



ARTICLE	PACKAGING	WIDTH, THICKNESS (mm)	BARCODE
PROFI 6 - 10/W2*	100	9	4042358005012
PROFI 8 - 12/W2*	100	9	4042358005029
PROFI 10 - 16/W2*	100	9	4042358005036
PROFI 12 - 18/W2*	100	9	4042358005043
PROFI 12 - 22/W2*	100	9	4042358005050
PROFI 16 - 27/W2*	100	9	4042358005067
PROFI 20 - 32/W2*	100	9	4042358005074
PROFI 25 - 40/W2*	100	9	4042358005081
PROFI 32 - 50/W2*	100	9	4042358005098
PROFI 40 - 60/W2*	50	9	4042358005104
PROFI 50 - 70/W2*	50	9	4042358005111
PROFI 60 - 80/W2*	25	9	4042358005128
PROFI 70 - 90/W2*	25	9	4042358005135
PROFI 80 - 100/W2*	25	9	4042358005142
PROFI 90 - 110/W2*	25	9	4042358005159
PROFI 100 - 120/W2*	25	9	4042358005166
PROFI 110 - 130/W2*	25	9	4042358005173
PROFI 120 - 140/W2*	25	9	4042358005180
PROFI 130 - 150/W2*	20	9	4042358005197
PROFI 140 - 160/W2*	20	9	4042358005203

* Stainless Steel 430

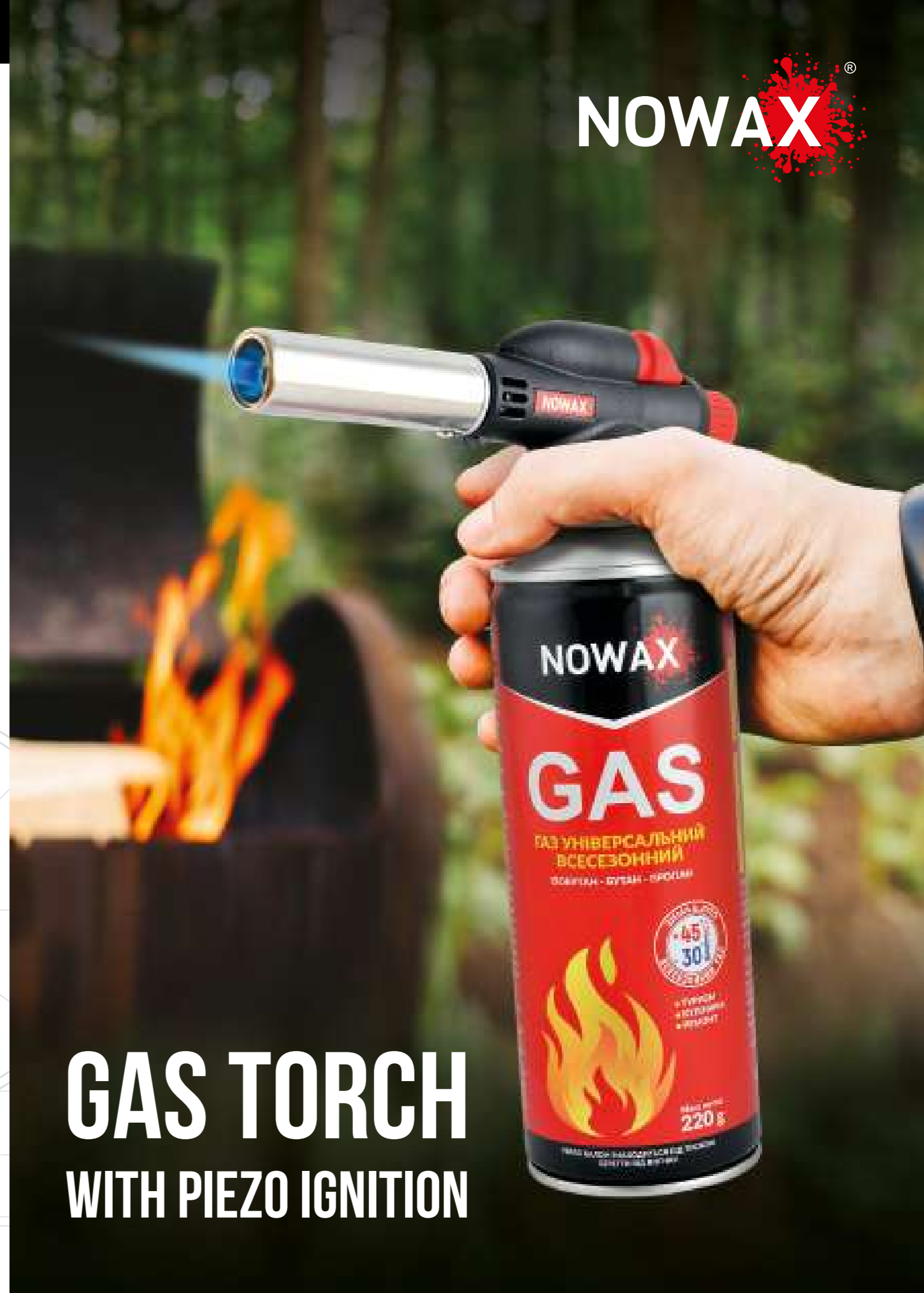

**GAS TORCH
WITH PIEZO IGNITION**



GAS TORCH
with piezo ignition
NX 12360

1300 °C / MAX. °C FLAME
106 g/h / GAS CONSUMPTION



Power: 1,45 kW
Nozzle protection: ceramic
Nozzle diameter: 20 mm
Nozzle length: 80 mm

Barcode:
0097254123609
Packaging:
10/100 pcs.

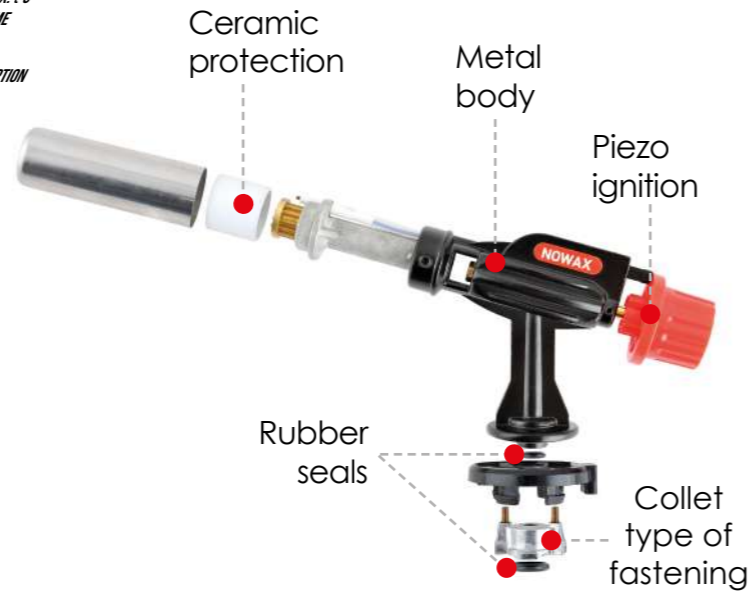

GAS TORCH
with piezo ignition
NX 12310

1300 °C / MAX. °C FLAME
95 g/h / GAS CONSUMPTION



Power: 1,3 kW
Nozzle protection: ceramic
Nozzle diameter: 22 mm
Nozzle length: 65 mm

Barcode:
0097254123104
Packaging:
10/100 pcs.

GAS TORCH
with piezo ignition
NX 12390

1300 °C / MAX. °C FLAME
95 g/h / GAS CONSUMPTION



Power: 1,3 kW
Nozzle diameter 20 mm
Nozzle length: 61 mm

Barcode:
0097254123906
Packaging: 10/100 pcs.

GAS TORCH
with piezo ignition
NX 12320

1300 °C / MAX. °C FLAME
95 g/h / GAS CONSUMPTION



Power: 1,3 kW
Nozzle protection: ceramic
Nozzle diameter: 20 mm
Nozzle length: 63 mm

Barcode:
0097254123203
Packaging:
10/100 pcs.

GAS TORCH
with piezo ignition
NX 12330

1300 °C / MAX. °C FLAME
95 g/h / GAS CONSUMPTION



Power: 1,3 kW
Nozzle diameter: 13,6 mm
Nozzle length: 74 mm

Barcode:
0097254123302
Packaging: 10/100 pcs.

GAS TORCH
with piezo ignition
NX 12300

1300 °C / MAX. °C FLAME
95 g/h / GAS CONSUMPTION



Power: 1,3 kW
Nozzle protection: ceramic
Nozzle diameter: 20 mm
Nozzle length: 60 mm

Barcode:
0097254123005
Packaging:
10/100 pcs.

GAS TORCH
with piezo ignition
NX 12370

1300 °C / MAX. °C FLAME
95 g/h / GAS CONSUMPTION



Power: 1,3 kW
Nozzle protection: ceramic
Nozzle diameter: 20 mm
Nozzle length: 64 mm

Barcode:
0097254123708
Packaging:
10/100 pcs.

GAS TORCH
with piezo ignition
NX 12340

1300 °C / MAX. °C FLAME
95 g/h / GAS CONSUMPTION



Power: 1,3 kW
Nozzle protection: ceramic
Nozzle diameter: 20 mm
Nozzle length: 61,5 mm

Barcode:
0097254123401
Packaging:
10/100 pcs.

GAS TORCH
with piezo ignition
NX 12350

1300 °C / MAX. °C FLAME
95 g/h / GAS CONSUMPTION



Power: 1,3 kW
Nozzle protection: ceramic
Nozzle diameter: 20 mm
Nozzle length: 63 mm

Barcode:
0097254123500
Packaging:
10/100 pcs.

GAS TORCH
with piezo ignition
NX 12380

1300 °C / MAX. °C FLAME
106 g/h / GAS CONSUMPTION



Power: 1,45 kW
Nozzle protection: ceramic
Nozzle diameter: 22 mm
Nozzle length: 80 mm

Barcode:
0097254123807
Packaging:
10/100 pcs.

- WELDING OF PIPE STRUCTURES
- HEATING OLD METAL PARTS
- DEFROSTING OF WATER SUPPLY PIPES AND LOCKS
- LIGHTING FIRES AND BARBECUE
- FOOD AND BEVERAGE PREPARATION

Warning:
use only in well ventilated area or outdoors

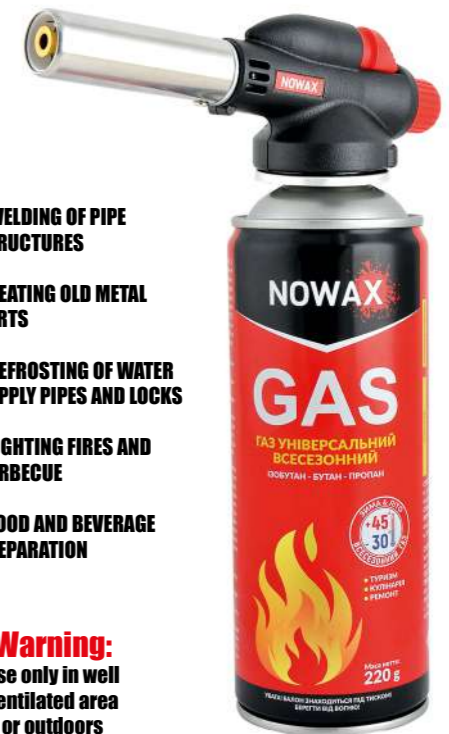

LEVER GREASE GUN

lever-plunger type

NX 12140

Barcode:
0097254121407

Packaging:
10 pcs.



grease supply tube

flexible hose 300 mm included

handle-lever

USE WITH:

14 OZ GREASE CARTRIDGE
500 CC BULK FILL

ergonomic rubber handle

container for grease 500 cm³

automatic stem fixation

USE FOR:



HOSE FOR LEVER GREASE GUN

lever-plunger type , 300 mm

NX 12121

Barcode:
0097254121216

Packaging:
10 pcs.



WORKING PRESSURE
310 BAR

LEVER GREASE GUN

lever-plunger type

NX 12120

Barcode:
0097254121209

Packaging:
10 pcs.

USE WITH:

14 OZ GREASE CARTRIDGE
500 CC BULK FILL



HAND ROTARY PUMP

for volume from 15 to 55 gallon

NX 12190

Barcode:
0097254121902

Packaging:
4 pcs.



PRODUCTIVITY:
5L / 20 TURNS
FOR DIESEL FUEL



LEVER ACTION BARREL PUMP

with metal intake

NX 12150



Ø 1,1/2" & 2" BUNG ADAPTER
CAPACITY:
300ML
IN 1 STROKE

Barcode:
0097254121506
Packaging:
10 pcs.

LEVER ACTION BARREL PUMP

with metal intake

NX 12170



Ø 1,1/2" & 2" BUNG ADAPTER
CAPACITY:
300ML
IN 1 STROKE

Barcode:
0097254121704
Packaging:
10 pcs.

LEVER ACTION BARREL PUMP

with plastic intake

NX 12180



Ø 1,1/2" & 2" BUNG ADAPTER
CAPACITY:
300ML
IN 1 STROKE

Barcode:
0097254121803
Packaging:
10 pcs.



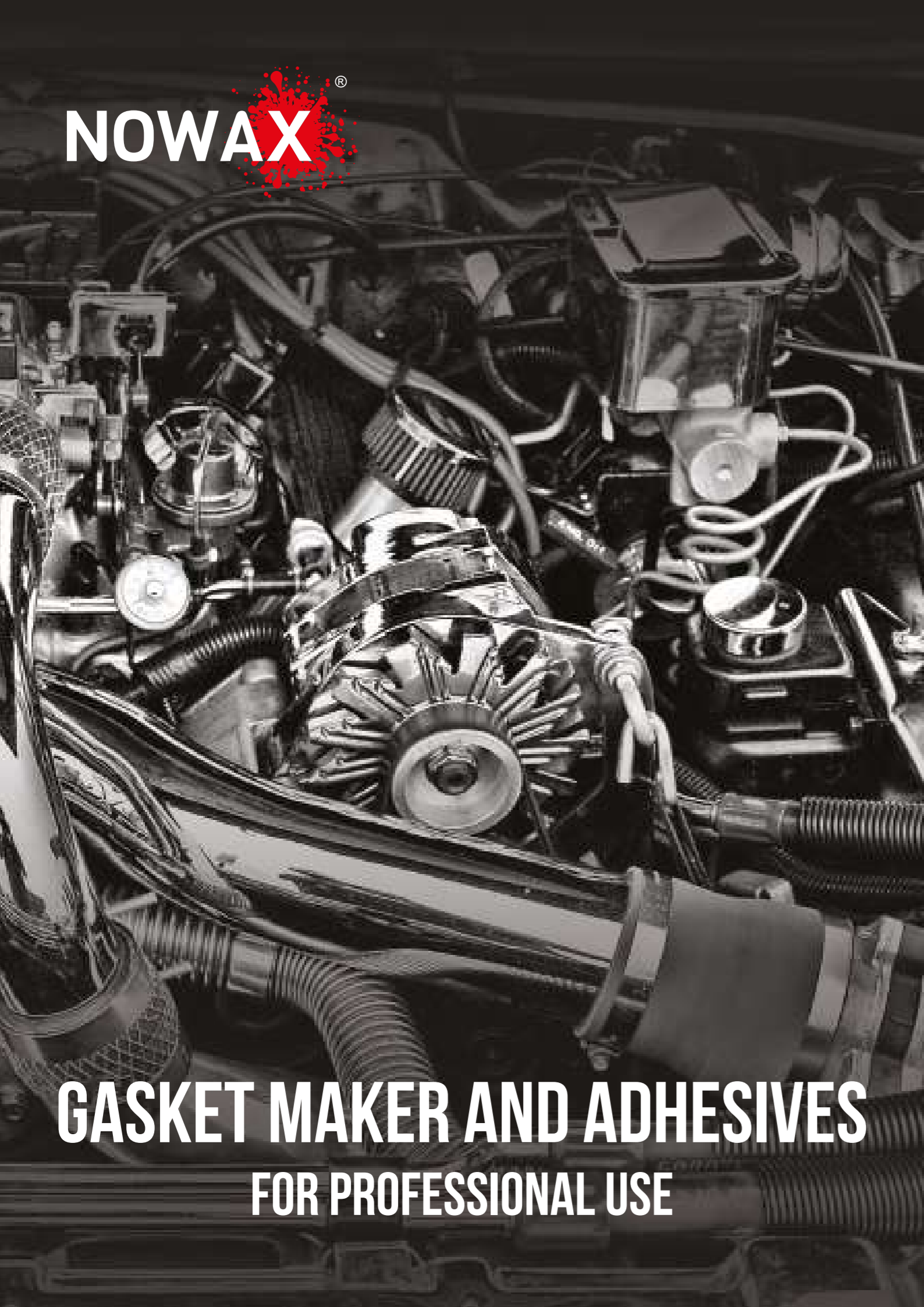

GASKET MAKER AND ADHESIVES FOR PROFESSIONAL USE

NX 51109
QUICK STEEL (EPOXY PUTTY), 57 g
(Cold welding)

Dark gray color. Designed for strong, tight and reliable connection of parts made of cast iron, steel, aluminum, copper, bronze, wood, brass, plastic.



Barcode:
0097254511093
Packaging:
24/288 pcs.

NX 51209
QUICK PLASTIC (EPOXY PUTTY), 57 g
(Cold welding)

Gray color. Intended for strong, tight and reliable connection of details from plastic, wood, metal.



Barcode:
0097254512090
Packaging:
24/288 pcs.

NX 48409
METAL BOND, 20 g

Epoxy glue of steel color.
Able to bond ceramics, wood, metal, leather, most plastics, porcelain, and even concrete. Resistant to water, gasoline, antifreeze, acid and most solvents.



Barcode:
0097254484090
Packaging:
12/144 pcs.

NX 48509
SUPER BOND, 20 g

Epoxy transparent glue.
Able to bond ceramics, wood, metal, leather, most plastics, porcelain, glass and even concrete. Resistant to water, gasoline, antifreeze, acid and most solvents.



Barcode:
0097254485097
Packaging:
12/144 pcs.

NX 49409
STEEL EPOXY ADHESIVE, 30 g

Epoxy glue to a wide range application.
Steel color.



Barcode:
0097254494099
Packaging:
12/144 pcs.

NX 49509
SUPER EPOXY ADHESIVE, 30 g

Epoxy glue to a wide range application.
Clear color.



Barcode:
0097254495096
Packaging:
12/144 pcs.



NX 49209
SUPER GLUE, 3 g

Universal instant glue for fast combination of different types of plastics, rubber, metals, wood, porcelain, ceramics, leather, fabric, cardboard and paper.



Barcode:
0097254492095
Quantity on the tablet:
6 pcs.
Packaging:
100 tablets



NX 49309
SUPER GLUE GEL, 3 g

Universal instant glue for fast combination of different types of plastics, rubber, metals, wood, porcelain, ceramics, leather, fabric, cardboard and paper.



Barcode:
0097254493092
Quantity on the tablet:
6 pcs.
Packaging:
100 tablets

NX 21139
THREADLOCKER BLUE, 10 g
(for collapsible connections)

Universal thread locker to seal thread with a diameter of 6 mm to 20 mm. Creates a strong elastic connection, does not lose its properties over time.



Barcode:
0097254211399
Packaging:
12/144 pcs.

NX 21129
THREADLOCKER RED, 10 g
(for non-demountable connections)

Particularly strong connections for sealins threaded parts that do not require frequent disassembly. Suitable for fasteners up to 25 mm in diameter.



Barcode:
0097254211290
Packaging:
12/144 pcs.

NX 11109
REARVIEW MIRROR ADHESIVE, 1 ml

Especially strong and fast-adhesive glue for mounting the rearview mirror. Can be used in the case of metal-glass, metal-metal, glass-glass compounds.



Barcode:
0097254111095
Packaging:
25/200 pcs.

NX 13215
EXHAUST SYSTEM SEALANT (CEMENT), 150 g +1100°C

High-temperature ceramic sealant ensures the tightness of the joints during the installation of exhaust systems, eliminates the emission of exhaust gases from small burnt holes and cracks.



Barcode:
0097254132151
Packaging:
12/144 pcs.

NX 36309
GASKET MAKER GRAY, +343°C, 85 g

Professional high temperature 100% silicone gasket maker. Gray color.

Barcode:
0097254363098
Packaging:
12/144 pcs.



NX 37309
GASKET MAKER RED, +343°C, 85 g

Professional high temperature 100% silicone gasket maker. Red color.

Barcode:
0097254373097
Packaging:
12/144 pcs.



NX 35309
GASKET MAKER BLACK, +315°C, 85 g

Professional high temperature 100% silicone gasket maker. Black color.

Barcode:
0097254353099
Packaging:
12/144 pcs.



NX 34309
GASKET MAKER CLEAR, +290°C, 85 g

Professional high temperature 100% silicone gasket maker. Clear.

Barcode:
0097254343090
Packaging:
12/144 pcs.



SEALANTS AND ADHESIVES



ULTRA BLUE MULTIPURPOSE RTV SILICONE GASKET MAKER

Permatex Ultra Blue is a multi-purpose sensor-safe, low-odor, non-corrosive RTV gasket maker. Ultra Blue is tested to OEM specifications and outperforms conventional silicones. Temperature range -54°C to 260°C intermittent; resists auto and shop fluids and vibration.

art. 85519

Weight : 340 g
Barcode : 0686226855190
Packaging : 6 pcs.



COPPER SPRAY-A-GASKET HI-TEMP SEALANT

Permatex Copper Spray-A-Gasket Hi-Temp Sealant is a fast-drying, metallic copper sealant that helps dissipate heat, preventing gasket burnout and improving heat transfer. This high temperature sealant spray sealant instantly and fills hot spots and surface imperfections and resists all types of automotive fluids.

art. 80697

Volume : 270 ml
Barcode : 0686226806970
Packaging : 12 pcs.



PERMASHIELD FUEL RESISTANT GASKET DRESSING & FLANGE SEALANT

Specially formulated for superior fluid resistance. This polyester urethane based gasketing compound withstands extreme temperature changes without hardening.

art. 85420

Volume : 59 ml
Barcode : 0686226854209
Packaging : 6 pcs.



ULTRA COPPER MAXIMUM TEMPERATURE RTV SILICONE GASKET

Permatex Ultra Copper is a high temperature RTV gasket maker, resisting temperatures up to 371°C. Ultra Copper is tested to exceed OEM specifications and is ideal for high temperature applications such as turbocharger applications and exhaust systems.

art. 81878

Weight : 85 g
Barcode : 0686226818782
Packaging : 12 pcs.



ULTRA BLUE MULTIPURPOSE RTV SILICONE GASKET MAKER

Permatex Ultra Blue is a multi-purpose sensor-safe, low-odor, non-corrosive RTV gasket maker. Ultra Blue is tested to OEM specifications and outperforms conventional silicones. Temperature range -54°C to 260°C intermittent; resists auto and shop fluids and vibration.

art. 81724

Weight : 95 g
Barcode : 0686226817242
Packaging : 12 pcs.



AUTOMATIC TRANSMISSION RTV GASKET MAKER

Specialty gasket maker that offers improved transmission oil resistance and good adhesion while retaining flexibility. It is sensor safe, non-corrosive and can be used as a gasket maker or dressing. This non-flammable, non-toxic and low order formulation resists again, weathering and thermal cycling without hardening, shrinking or cracking.

art. 81180

Weight : 85 g
Barcode : 0686226811806
Packaging : 12 pcs.



GEAR OIL RTV GASKET MAKER

Specialty gasket maker that is specially formulated to withstand the harsh gear oil environment found in differentials and transfer cases, ensuring a leak-proof seal. This specialty silicone has been tested to OEM specifications to ensure complete sealing. Gear Oil RTV Gasket Maker seeks and seals leak paths that cut gaskets cannot and can also be used to seal cut gaskets.

art. 81182

Weight : 85 g
Barcode : 0686226811820
Packaging : 12 pcs.



FORM-A-GASKET NO. 1 SEALANT

Fast drying, hard setting sealant designed for sealing rigid materials and flanges, or patching holes and joints where permanent assembly is desired. It is resistant to common shop fluids and fuels.

art. 80008

Weight : 85 g
Barcode : 0686226800084
Packaging : 12 pcs.



VALVE GRINDING COMPOUND

Permatex Valve Grind Compound aids valve grinding and seating operations to remove burrs, surface defects, carbon, gum and corrosion. Use Permatex Valve Grind Compound for lapping and grinding chromium. Mixes with water to form an easy-to-use paste.

art. 80037

Weight : 85 g
Barcode : 0686226800374
Packaging : 12 pcs.



FLOWABLE SILICONE WINDSHIELD & GLASS SEALER

Permatex Flowable Silicone Windshield & Glass Sealer "seeks the leak" flowing into hidden and hard-to-reach areas, forming a tough, waterproof, durable, clear seal that resists weather, extreme temperatures, vibration, shock, and most shop chemicals.

art. 81730

Weight : 42 g
Barcode : 0686226817303
Packaging : 12 pcs.



RUST TREATMENT

Provides one-step treatment that encapsulates old rust and prevents new rust within minutes. Just brush or spray on. Within minutes, rust is replaced by a durable black polymer coating that may be painted. Excellent protective primer. Specially formulated to be used with body filler and fiberglass.

art. 81775

Weight : 236 g
Barcode : 0686226817754
Packaging : 12 pcs.



RUST TREATMENT

Provides one-step treatment that encapsulates old rust and prevents new rust within minutes. Just brush or spray on. Within minutes, rust is replaced by a durable black polymer coating that may be painted. Excellent protective primer. Specially formulated to be used with body filler and fiberglass.

art. 81849

Volume : 300 ml
Barcode : 0686226818492
Packaging : 12 pcs.



REAR WINDOW DEFOGGER ELECTRICALLY CONDUCTIVE TAB ADHESIVE

Permatex's Rear Window Defogger Electrical Conductive Tab Adhesive quickly and easily bonds defogger tab to grid on rear window. Provides a low-cost, high-quality repair for damaged rear window defogger tabs. Complete kit for a quick repair.

art. 21351

Barcode : 0686226213518
Packaging : 6 pcs.



BULLSEYE WINDSHIELD REPAIR KIT

Can be used to make air-tight repairs of bullseye damage up to 1 1/4" in diameter on most laminated windshield glass. This all-in-one kit is safe and easy to use and requires no mixing, no heat, making the repair virtually undetectable.

art. 16067

Barcode : 0686226160676
Packaging : 12 pcs.



MOTOR MUSCLE CARB & CHOKE CLEANER

Permatex Motor Muscle Carb & Choke Cleaner is a blend of solvents specifically formulated to dissolve and clean the residue deposited on carburetors and chokes during the normal operation of a motor vehicle or other gasoline engine powered equipment.

art. 80079

Weight : 340 g
Barcode : 0686226800794
Packaging : 12 pcs.



HEAVY-DUTY RUBBERIZED UNDERCOATING

Permatex Heavy Duty Rubberized Undercoating is specially formulated to protect automotive underbodies from corrosion. The product dries to a firm, flexible, tack-free film has good abrasion resistance and effective sound-deadening properties. Rubberized for maximum thickness, durability and flexibility.

art. 81833

Weight : 454 g
Barcode : 0686226818331
Packaging : 12 pcs.



COMPLETE REAR WINDOW DEFOGGER REPAIR KIT

Repair Kit contains everything required for making professional-quality repairs in just minutes. Includes state-of-the-art components and easy-to-follow instructions with photographs. Provides a low-cost, high-quality repair for damaged rear window defogger grids and tabs.

art. 09117

Barcode : 0686226091178
Packaging : 6 pcs.



VINYL AND LEATHER REPAIR KIT

Repair kit for home, automotive, and marine vinyl and leather upholstery. This easy-to-use kit contains: heat transfer tool, 7 colors of repair compound, clear vinyl adhesive and filler, grain pattern paper, plastic spatula, and instruction sheet with color matching chart.

art. 80902

Barcode : 0686226809025
Packaging : 6 pcs.



ULTRA DISK BRAKE CALIPER LUBE

An environmentally-friendly, green, non-melting, synthetic lubricant. This is formulated to lubricate under the most adverse brake conditions, assuring that critical caliper pins, sleeves, bushings and pistons remain lubricated throughout pad life.

art. 24110

Weight : 227 g
Barcode : 0686226241108
Packaging : 12 pcs.



ULTRA DISK BRAKE CALIPER LUBE

An environmentally-friendly, green, non-melting, synthetic lubricant. This is formulated to lubricate under the most adverse brake conditions, assuring that critical caliper pins, sleeves, bushings and pistons remain lubricated throughout pad life.

art. 20353

Weight : 57 g
Barcode : 0686226203533
Packaging : 6 pcs.



SELF-FUSING SILICONE TAPE

An all purpose repair tape that is made out of specially formulated silicone rubber. Contains no adhesives, yet chemically bonds to itself upon contact. Simply stretch and wrap for an airtight, waterproof seal in seconds. Replaces duct tape and electrical tape.

art. 82112

Barcode : 0686226821126
Packaging : 6 pcs.



BODY SHOP HEAVY DUTY HEADLINER & CARPET ADHESIVE

High-strength spray adhesive designed for repairing interior parts which have become detached or loosened. This heavy duty adhesive will adhere to headliners, carpets, truck linings and indoor door panels. It's resistant to extreme weather conditions and dries clear for a clean finish.

art. 27828

Weight : 474 g
Barcode : 0686226278289
Packaging : 6 pcs.



ULTRA DISC BRAKE CALIPER LUBE

Permatex's Ultra Disc Brake Caliper Lubricant is environmentally-friendly, green, non-melting, synthetic lubricant. It is formulated to lubricate under the most adverse brake conditions, assuring that critical caliper pins, sleeves, bushings and pistons remain lubricated throughout pad life.

art. 85188

Weight : 14 g
Barcode : 0686226851888
Packaging : 6 pcs.



HIGH TEMPERATURE SLEEVE RETAINER

Permatex High Temperature Sleeve Retainer is a one component, solvent-free, fast curing, anaerobic adhesive/sealant. It is a green colored liquid resin that hardens and cures in the absence of air.

art. 64050

Volume : 50 ml
Barcode : 0686226640505
Packaging : 6 pcs.



ULTRA SLICK ENGINE ASSEMBLY LUBE

Provides proper lubrication of metal mating surfaces is essential prior to starting a new or rebuilt engine. Ultra slick® adheres to component surfaces to prevent scuffing and galling during initial start-up. This high quality formulation meets or exceeds OEM performance specs for engine assembly lubricants.

art. 81950

Volume : 118 ml
Barcode : 0686226819505
Packaging : 12 pcs.



BELT DRESSING & CONDITIONER

Permatex Belt Dressing and Conditioner extends belt life and penetrates the cord fibers of "V" belts to restore pliability and flexibility. Belt Dressing and Conditioner prevents belt slippage due to heat, cold, dampness, dust, and glazing. Eliminates squeaking and slipping.

art. 80073

Weight : 340 g
Barcode : 0686226800732
Packaging : 12 pcs.

art. 80074

Weight : 141 g
Barcode : 0686226800749
Packaging : 12 pcs.



LOW STRENGTH THREADLOCKER PURPLE

Permatex Threadlocker Purple is a low strength threadlocker designed for fasteners under 6mm that require occasional adjustment. Removable with hand tools for easy disassembly. Threadlocker Purple eliminates vibration loosening, prevents leaks and is non-corrosive

art. 24024

Volume : 6 ml
Barcode : 0686226240248
Packaging : 6 pcs.



MEDIUM STRENGTH THREADLOCKER BLUE

Permatex Medium-Strength Threadlocker Blue is ideal for all nut and bolt applications 6mm to 20mm. Threadlocker Blue eliminates need for stocking expensive lock nuts and lock washers and locks and seals while preventing parts loosening due to vibration. Protects threads from corrosion.

art. 24200

Volume : 6 ml
Barcode : 0686226242006
Packaging : 12 pcs.



CREAM PLASTIC WELDER

Permatex Plastic Welder Epoxy is a structural adhesive designed for general purpose bonding of a wide variety of material such as hard and soft plastics to specified surfaces. This Plastic Welder forms a tough, durable bond to most plastics, composites, ceramics, wood in any combination.

art. 84115

Volume : 25 ml
Barcode : 0686226841155
Packaging : 12 pcs.



1 MINUTE GEL EPOXY

Permatex General Purpose 1 Minute Gel Epoxy provides the flexibility to reposition before the setting time. The fast setting, two-part adhesive and filler system is specially formulated with a Blue Dye Indicator that disappears when it's fully mixed and ready to use.

art. 84160

Volume : 25 ml
Barcode : 0686226841605
Packaging : 6 pcs.



HIGH STRENGTH THREADLOCKER RED

Is ideal for heavy-duty applications. 10mm to 25mm Red threadlocker is well-suited for permanently locking studs and press fits. Adds holding power on slip and press fit assemblies, and replaces set screws and snap rings. Permatex's Threadlocker Red locks against vibration loosening. May require heat or special tools for removal.

art. 27100

Volume : 6 ml
Barcode : 0686226271006
Packaging : 12 pcs.



PENETRATING GRADE THREADLOCKER GREEN

Permatex Penetrating Grade Threadlocker Green is a low viscosity threadlocking liquid that wicks along the threads of preassembled fasteners to secure them in place. Since it is applied after assembly, preventive maintenance procedures are simplified. Ideal for fasteners ranging from 2.2 to 12mm in size.

art. 29000

Volume : 6 ml
Barcode : 0686226290007
Packaging : 12 pcs.



5 MINUTE EPOXY

Permatex General Purpose 5 Minute Gel Epoxy provides the flexibility to reposition before the setting time. The fast setting, two-part adhesive and filler system is specially formulated with a Blue Dye Indicator that disappears when it's fully mixed and ready to use.

art. 84101

Volume : 25 ml
Barcode : 0686226841155
Packaging : 12 pcs.



HIGH HEAT EPOXY 260°C

Ideal for surface repairs with high temperatures such as under-hood automotive & home repair. This high temperature epoxy withstands 2X higher temperatures compared to standard epoxies that traditionally breakdown at 121°C. Ideal for under-hood repairs where temperatures can range up to 260°C on a hot summer day.

art. 84102

Volume : 25 ml
Barcode : 0686226841605
Packaging : 6 pcs.



HIGH TEMPERATURE THREAD SEALANT

Permatex High Temperature Thread Sealant is a medium strength anaerobic sealant with PTFE for tapered pipe threads. This sealing compound is of a white, creamy paste consistency. The high lubricating properties of this compound prevents galling on pipe threads and fittings.

art. 59214

Volume : 6 ml
Barcode : 0686226592149
Packaging : 12 pcs.



DIELECTRIC TUNE UP GREASE

Permatex Dielectric Tune Up Grease protects electrical connections and wiring from salt, dirt and corrosion. Extends the life of bulb sockets and prevents voltage leakage around any electrical connection. Also prevents spark plugs from fusing to boots.

art. 81150

Volume : 10 ml
Barcode : 0686226811509
Packaging : 6 pcs.



MARINE H2 HOLD EPOXY

Permatex Marine H2 Hold Epoxy bonds underwater applications without breaking and can be used on both under and above water repairs. This industrial strength waterproof epoxy is ideal for surfaces exposed to salt or freshwater such as portable water tanks, fuel tanks, drains, boats, and more!

art. 84200

Volume : 25 ml
Barcode : 0686226841155
Packaging : 12 pcs.



COLD WELD BONDING COMPOUND

Permatex Cold Weld Bonding Compound is a 15-minute, two-part adhesive and filler system that eliminates the need for welding or brazing. It repairs, fills and bonds to iron, steel, brass, bronze, aluminum and copper. Once cured, it can be drilled, tapped, threaded, filed, sanded and painted.

art. 14600

Weight : 56 g
Barcode : 0686226146007
Packaging : 12 pcs.



RTV SILICONE GASKET MAKER

Ultra Black is sensor safe, low odor, and non-corrosive with resistance to oil, shop fluids, and vibration. This sensor-safe, low odor, non-corrosive formula meets performance specifications of OE silicone gaskets and can be used on high flexibility and high oil resistant applications such as timing covers, transmission pans and oil pans.

art. 82180

Weight : 95 g
Barcode : 0686226821805
Packaging : 12 pcs.



LIQUID ELECTRICAL TAPE

This electrical tape goes on as a liquid and dries to a vinyl polymer, making it resistant to dirt, dust, chemicals, moisture. This advanced design ensures that connections stay intact. The Applicator allows wide coverage without gaps and allows access to tight spaces that traditional roll tape and shrink tubing can not reach.

art. 85120

Volume : 118 ml
Barcode : 0686226851208
Packaging : 6 pcs.

 	Epoxies						multi-metal		WELD				
	General purpose						4 MINUTE STEEL EPOXY	TITANIUM 5® EPOXY	COLD WELD BONDING COMPOU	STEEL WELD® EPOXY	PLASTIC WELDER®	PLASTIC WELDER®	
	FAST SETTING 1 MINUTE EPOXY	5 MINUTE GEL EPOXY	500° HIGH HEAT EPOXY	MARINE H2 HOLD EPOXY	5 MINUTE® CLEAR EPOXY	5 MINUTE® CLEAR EPOXY							
Article	84160	84101	84102	84200	43109	46409	44209	47909	14600	47709	47809	84115	Article
Set time	60s	5min	10min	15min	5min	5min	4min	5min	8min	2h	15min	5min	Set time
Max. temp. °C	+82	+82	+260	+82	+93	+93	+105	+93	+149	+93	+93	+121	Max. temp. °C
Min. temp. °C	-51	-51	-51	-51	-40	-40	-184	-15	-51	-5	-5	-51	Min. temp. °C
Color	Transparent	Transparent	Transparent	Beige	Transparent	Transparent	Black	Gray	Gray	Black	Beige	Beige	Color
PSI	2500	3400	2500	4000	1500	1500	3000	2500	3000	2600	3500	3500	PSI
Kg/cm²	176	239	176	281	105,5	105,5	211	176	211	183	246	246	Kg/cm²
ABS - plastic	•	•	•	•							•	•	ABS - plastic
Acrylic				•							•	•	Acrylic
Aluminum	•	•	•	•			•	•	•	•			Aluminum
Ceramics											•	•	Ceramics
Chrome	•	•	•	•	•	•							Chrome
Concrete					•	•	•				•	•	Concrete
Copper/Brass		•	•	•				•	•	•			Copper/Brass
Fiberglass	•			•	•	•					•	•	Fiberglass
Glass	•	•	•	•	•	•					•	•	Glass
Porcelain					•	•					•	•	Porcelain
Iron		•	•	•			•	•	•	•			Iron
Metal	•	•	•	•	•	•	•	•	•	•	•	•	Metal
Rubber													Rubber
Bronze							•	•	•	•			Bronze
Titanium								•	•	•			Titanium
Tin								•	•	•			Tin
Textile													Textile
Hard PVC				•							•	•	Hard PVC
Stainless Steel		•	•					•	•	•			Stainless Steel
Steel	•	•	•				•	•	•	•	•	•	Steel
Wood				•	•	•					•	•	Wood



art. 44029
MAGNUM STEEL EPOXY, 56 g

A fast-curing, two-part epoxy putty stick that permanently repairs leaks, holes, cracks in metals, fiberglass, concrete and ceramics. Use to repair pipes, tanks, radiators and couplings. When cured it can be drilled, filed, sanded and painted.

Barcode : 078727440294
Packaging : 24 pcs.



art. 44229
MAGNUM PLASTIC/MARINE EPOXY, 56 g

A fast-curing, two-part epoxy putty stick that permanently repairs leaks, holes, cracks in metals, fiberglass, concrete, ceramics and wood. Product cures underwater (fresh and saltwater applications). Dries white, does not shrink, is non-yellowing and rustproof.

Barcode : 078727442298
Packaging : 24 pcs.



art. 11109
REAR VIEW MIRROR ADHESIVE

A two-part adhesive that permanently bonds metal mirror buttons to windshields.

Barcode : 078727111095
Packaging : 12 pcs.



art. 13109
ANTI-SEIZE THREAD LUBRICANT, 28 g

Anti-Seize Thread Lubricant is a high temperature, premium quality copper anti-seize and thread lubricant. It contains a high percentage of micro-fine copper flakes in a semisynthetic, grease carrier and fortified with high quality rust and corrosion inhibitors.

Barcode : 078727131093
Packaging : 12 pcs.



art. 43109
5 MINUTE CLEAR EPOXY, 28.4 g

5 Minute Epoxy is a two-part, rapid-curing, clear, general purpose epoxy. Available in syringe, tubes, bottles and flow-mix applicator.

Barcode : 078727431094
Packaging : 12 pcs.



art. 44209
4 MINUTE STEEL EPOXY, 56.7 g

This industrial strength product is excellent for bonding metal to metal and for repairing and filling defects in metal, wood and masonry. The epoxy hardens to a rigid metallic mass (like steel); once cured it can be drilled, tapped, sanded, filed, painted and etc. Product dries by chemical reaction between the hardener and resin.

Barcode : 078727442090
Packaging : 12 pcs.



art. 00911
BATTERY NO-CORRODE GEL, 4 g

The Battery No-Corrode Gel prevents corrosion on battery terminals and electrical connections that help extend battery life. It has a high dropping point and gives outstanding performance to high temperature applications.

Barcode : 078727009118
Packaging : 240 pcs.

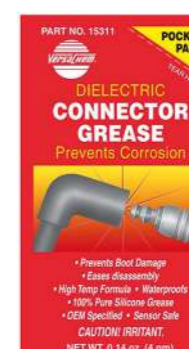

art. 15311
DIELECTRIC CONNECTOR GREASE, 4 g

Dielectric Connector Grease is a high performance, 100% silicone dielectric compound that enables boots to be removed from spark plugs and distributor caps after long exposure to high energy ignition systems and hot engine temperatures. Use on all electrical connections to prevent electrical power from migrating between circuitry.

Barcode : 078727153118
Packaging : 240 pcs.



art. 46409
5 MINUTE CLEAR EPOXY, 25 ml

5 Minute Epoxy is a two-part, rapid-curing, clear, general purpose epoxy. Available in syringe, tubes, bottles and flow-mix applicator.

Barcode : 078727464092
Packaging : 12 pcs.



art. 47709
STEEL WELD EPOXY, 25 ml

Plastic Steel/Steel Weld Epoxy is a two part, fast curing, high strength, general purpose epoxy. A cold welding compound, when fully cured it can be drilled, threaded, machined, tapped or filed. This product does not contain steel.

Barcode : 078727477092
Packaging : 12 pcs.

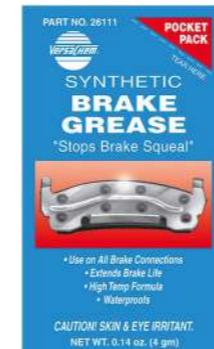

art. 26111
SYNTHETIC CALIPER GREASE, 4 g

Synthetic Caliper Grease is a high quality, synthetic brake grease formulated to prevent disc brake squeal and increase brake life by protecting and lubricating brake parts. Prevents rust and corrosion.

Barcode : 078727261110
Packaging : 240 pcs.



art. 13209
METAL GRINDING COMPOUND, 42,5 g

Metal Grinding Compound is a high temperature grease containing sharp, graded and extremely hard grains of silicon carbide. Use it for lapping, grinding, sharpening and polishing metal surfaces. Helps in valve grinding operations on automotive, industrial and marine engines.

Barcode : 078727132090
Packaging : 12 pcs.



art. 47809
PLASTIC WELDER, 25 ml

A strong structural adhesive formulated for bonding dissimilar substrates as well as unprepared metals, ceramics, wood, concrete and hard plastics. The final adhesive bond is designed to be load bearing and resistant to weathering, humidity and wide temperature variations. Minimal surface preparation. Non-sagging formula.

Barcode : 078727478099
Packaging : 12 pcs.



art. 47909
TITANIUM 5 EPOXY, 25 ml

Fast setting titanium-filled epoxy that bonds like and unlike metals with superior strength that will not shrink. Fills cracks, voids and gaps in all metals. Can be drilled, tapped, machined and sanded after cure.

Barcode : 078727479096
Packaging : 12 pcs.



art. 14109
HEAVY DUTY RADIATOR STOP LEAK, 21 g

The Heavy Duty Radiator Stop Leak works quickly and easily to stop larger leaks. Contains pure copper particles, special hardening and sealing agents to fill holes. Compatible with antifreeze. Prevents rust.

Barcode : 078727141092
Packaging : 12 pcs.



art. 90110
WINDSHIELD REPAIR KIT

Windshield Repair Kit helps prevent damage from spreading on windshield glass from bulls eyes, star damage and chips up to 11/4 inches. The spring-lock feature makes professional quality repairs with no mixing required. Cures in sunlight and restores to crystal clear.

Barcode : 085117901105
Packaging : 6 pcs.



art. 82009
EXHAUST SYSTEM REPAIR TAPE, 5 cm x 101.6 cm

Exhaust System Repair Tape is a high strength aluminum foil coated with an aggressive, high temperature acrylic adhesive. Conforms to both fibrous and sheet metal ducts providing excellent vapor seal. Fast and easy to apply.

Barcode : 078727820096
 Packaging : 12 pcs.



art. 10160
EXHAUST SYSTEM JOINT & CRACK SEALER, 142 g

The Exhaust System Joint and Crack Sealer seals holes and stops leaks in mufflers, tailpipes and around joints. Sets like a weld. Makes new installations more secure. Resistant to monoxide gases and high temperatures.

Barcode : 077678001608
 Packaging : 12 pcs.



art. 90214
PLASTIC TANK AND RADIATOR REPAIR KIT

This complete repair kit permanently repairs gasoline and diesel fuel tank leaks in less than 20 minutes. Use it to repair pinholes, rust-outs, hairline cracks and holes up to 1/2" in diameter. No tank removal necessary.

Barcode : 085117902140
 Packaging : 6 pcs.



art. 90180
HEAVY-DUTY FUEL TANK REPAIR KIT

This complete repair kit permanently repairs gasoline and diesel fuel tank leaks in less than 20 minutes. Use it to repair pinholes, rust-outs, hairline cracks and holes up to 1/2" in diameter. No draining and no welding required.

Barcode : 085117901808
 Packaging : 6 pcs.



art. 88839
MEGA COPPER SILICONE, 85 g

Mega Copper Silicone is a high temperature, moisture curing gasketing material that resists temperatures up to 700°F. Forms a strong silicone rubber that remains flexible. Resists aging and weathering. Non-corrosive to steel, iron and aluminum.

Barcode : 078727888393
 Packaging : 12 pcs.



art. 99939
MEGA GREY SILICONE, 85 g

Mega Grey Silicone is a high performance, moisture curing gasketing material that cures into a strong silicone rubber that maintains long term durability and flexibility to make formed-in-place gaskets. Forms a tough, flexible silicone rubber gasket that resists aging and weathering.

Barcode : 078727999396
 Packaging : 12 pcs.



STORM GROUP



facebook



You Tube



© 2022. All rights reserved.

Belauto®, Belauto Off Road®, Sonar®, JBL®, Bi-Plast®,
Beltex®, Uragan®, Solar Electric®, Brevia®, Alligator®,
Carlife®, Carlife Tools®, Profi®, Mölder®, Mölder Filter®,
Mölder Tools®, Nowax®, Cobra®, Versachem®, Permatex®
registered trademark.

e-mail: office@storm-group.eu